

# CATALOGO DE **HERRAMIENTAS MANUALES PARA PROFESIONALES**



## CARROS

## CARRO DE 5 CAJONES



## CARRO DE 6 CAJONES



## CARRO DE 7 CAJONES



- Carro 5 cajones robusto
  - Dimensiones interiores de los cajones:
    - (1x) 543 x 445 x 50 mm
    - (2x) 543 x 445 x 116 mm
    - (2x) 543 x 445 x 182 mm
  - Gran capacidad
  - Chasis doble pared que protege los laterales para no dañar los cajones ante golpes
  - Reforzado en sitios claves para evitar puntos débiles
  - Guías de rodamientos de bolas en los cajones con 100% de apertura
  - Sistema 'click' de apertura y cierre de cajones
  - Sistema de cierre seguro y robusto
  - Ruedas de 125 x 30 mm con rodamientos de bola y goma que no marca:
    - 2 fijas y 2 giratorias con freno
- Carro 6 cajones robusto
  - Dimensiones interiores de los cajones:
    - (3x) 543 x 445 x 50 mm
    - (2x) 543 x 445 x 116 mm
    - (1x) 543 x 445 x 246 mm
- Carro 7 cajones robusto
  - Dimensiones interiores de los cajones:
    - (5x) 543 x 445 x 50 mm
    - (1x) 543 x 445 x 116 mm
    - (1x) 543 x 445 x 246 mm

R	Icono	Altura (mm)	Profundidad (mm)	Altura (mm)	Profundidad (mm)	Altura (mm)	Profundidad (mm)	kg
9066K5	1	677	501 x 954	400	543 x 445 x h	25	125 x 30	48
9066K6	1	677	501 x 954	400	543 x 445 x h	25	125 x 30	51
9066K7	1	677	501 x 954	400	543 x 445 x h	25	125 x 30	52

## GABINETE DE 4 CAJONES



- Gabinete 4 cajones robusto
- Gran capacidad
- Chasis doble pared que protege los laterales para no dañar los cajones ante golpes
- Reforzado en sitios claves para evitar puntos débiles
- Guías de rodamientos de bolas en los cajones con 100% de apertura
- Sistema 'click' de apertura y cierre de cajones
- Sistema de cierre seguro y robusto
- Dimensiones interiores de los cajones:
  - (3x) 543 x 445 x 50 mm
  - (1x) 543 x 445 x 116 mm

R	Icono	Altura (mm)	Profundidad (mm)	Altura (mm)	Profundidad (mm)	kg	
9065K4	1	677	501 x 420	250	543 x 445 x h	25	38

## REPUESTOS

9066K-01	Guías (2x) - 30 kg de capacidad
9066K-02	Dos ruedas giratorias de 125 x 30 mm
9066K-03	Dos ruedas fijas de 125 x 30 mm
9066K-05	Asa lateral para serie 9066K
9066K-06	Encimera de goma
9064-15	Asas laterales para cofre
9064AC01	Set 7 alfombrillas protectoras para los cajones

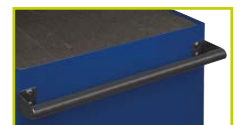

CARRO DE 6 CAJONES CON FOAMS Y HERRAMIENTAS, 178 piezas



IFF1A004



IFF1A005



IFF1A006

9066K6FF101

1

677 x 501 x 950

80

IFF1A004

101-04-1, 101-045-1, 101-05-1, 101-055-1, 101-06-1, 101-07-1, 101-08-1, 101-09-1, 101-10-1, 101-11-1, 101-12-1, 101-13-1

1/4"



103-04-1, 103-05-1, 103-06-1, 103-07-1, 103-08-1, 103-09-1, 103-10-1, 103-11-1, 103-12-1, 103-13-1

1/2"



105-22-1, 105-24-1



105-40-1



105-42-1



105-48-1



105-50-1

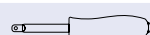

105-70-1



121-10-1, 121-11-1, 121-12-1, 121-13-1, 121-14-1, 121-15-1, 121-17-1, 121-19-1, 121-22-1, 121-24-1, 121-27-1, 121-30-1, 121-32-1

1/2"



125-23-1, 125-25-1

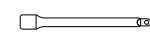

125-40-1



125-42-1

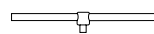

125-48-1



125-54-1



125-70-1

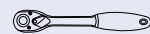

407-4-100, 407-5-5-125, 407-6-5-150, 407-8-175

1



408-6-5-25

1



409-1-100, 409-2-125, 409-3-150

+



409-2-25

+



413-1-100, 413-2-125

+



IFF1A005

529171

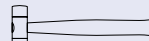

527-61-2



475-61-1

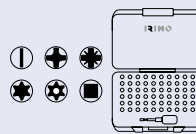

48-9-H

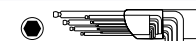

501-250-1



511-105-1



515-002-1, 515-003-1, 515-004-1, 515-005-1, 515-006-1



5-150C-1, 5-250C-1



601-180-1



612-160-1



625-180-1



634-250-1



665-200-1



980-3B-1



IFF1A006

25-06-2, 25-07-2, 25-08-2, 25-09-2, 25-10-2, 25-11-2, 25-12-2, 25-13-2, 25-14-2, 25-15-2, 25-16-2, 25-17-2, 25-18-2, 25-19-2, 25-21-2, 25-22-2, 25-24-2, 25-27-2, 25-30-2, 25-32-2



10-0607-1, 10-0809-1, 10-1011-1, 10-1213-1, 10-1415-1, 10-1617-1, 10-1819-1, 10-2022-1, 10-2123-1, 10-2427-1, 10-3032-1

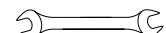

9066K6



1

2

3

4

5

6

7

8

9

10

11

12

CARROS

CARRO SOPORTE CON CAJAS APILABLES SOBRE RUEDAS



- Los múltiples compartimentos permiten almacenar de manera ordenada las herramientas para evitar pérdidas de tiempo
- Combinación de acero (proporcionando robustez) y polipropileno (ligereza)
- Apoyado en una base de ruedas y mango telescópico, que facilita el transporte aún cuando está muy cargado
- Ruedas goma: 125 x 35 mm
- Incluye candado para bloquear toda la torre
- Los 3 compartimentos se apilan gracias a sus pestañas metálicas laterales
- **Caja superior:** 485 x 225 x 210 mm  
Se puede utilizar como caja independiente y se puede cerrar con el candado por separado  
Manija grande de aluminio que permite un transporte fácil  
Manijas retraíbles laterales integradas que ayudan a levantar cuando la carga es elevada  
Bandeja incluida 450 x 185 x 45 mm
- **Caja intermedia:** 390 x 215 x 60 mm  
2 cajones con sistema de rodamientos y apertura total.  
Se puede utilizar como caja independiente y se puede cerrar con el candado por separado.  
Manijas retraíbles laterales integradas que ayudan a levantar cuando la carga es elevada
- **Compartimento inferior integrado:** 403 x 200 x 265 mm  
Cajón de amplias dimensiones para alojar herramienta de mayor tamaño y accesorios
- Manija telescópica que conforma la estructura del carro en cuatro posiciones:  
645 mm, 800 mm, 900 mm, 995 mm

R	mm	kg	
9021FTW520	1	520 x 320 x 720	15

REPUESTOS

9021FTW520-AC1	2 ruedas y husillo	125 x 35 mm
9021FTW520-AC2	Cierre para torre	
9021FTW520-AC3	Torre con 4 cierres	
9021FTW520-AC4	Mango telescópico	
9021FTW520-AC5	Manija de aluminio caja superior	

TORRE 3 CAJONES CON RUEDAS, 98 piezas



R	mm	kg	
9021FTW520FF1	1	520 x 320 x 720	22.5
101-04-1, 101-045-1, 101-05-1, 101-055-1, 101-06-1, 101-07-1, 101-08-1, 101-09-1, 101-10-1, 101-11-1, 101-12-1, 101-13-1, 101-14-1		1/4"	
121-08-1, 121-10-1, 121-11-1, 121-12-1, 121-13-1, 121-14-1, 121-16-1, 121-17-1, 121-19-1, 121-21-1, 121-22-1		1/2"	
105-70-1		475-1/4-125	
105-40-1		105-50-1	
105-22-1		105-24-1	
105-42-1		125-70-1	
125-40-1		125-43-1	
125-23-1		125-25-1	
46-8-F		475-32-1	
407-5.5-125		409-1-100	
407-6.5-150		409-2-125	
612-160-1		601-180-1	
625-180-1		604-160-1	
5-250C-1		522-31-2	
634-250-1		665-200-1	
25-08-1, 25-09-1, 25-10-1, 25-11-1, 25-12-1, 25-13-1, 25-14-1, 25-17-1, 25-19-1			

9021FTW520

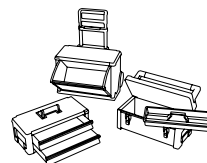

## TRANSPORTADORES

### TRANSPORTADOR 90 KG

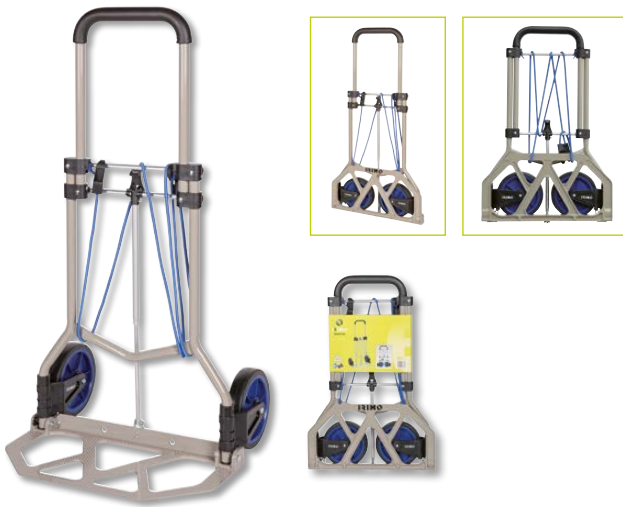

- Robusto
- Bandas elásticas para asegurar la carga
- Estructura de acero
- Base de aluminio, 250 x 450 mm
- Ruedas 170 mm
- Medidas: 480 x 420 x 740-100 mm
- Peso: 4,3 kg

9063FT90	1	250 x 450	90	170	4.3

### CAJA DE HERRAMIENTAS DE PLÁSTICO



- Caja de plástico para herramientas con dos niveles
- Parte superior: 18 compartimentos para almacenar pequeñas piezas
- Resistente tapa transparente
- Con sistema de bloqueo con dos cierres metálicos
- Manija de acero tubular con empuñadura de plástico para mayor confort y fácil transporte

9023PT565	1	170 x 565 x 320	2.4

## CAJAS METÁLICAS

### CAJA RÍGIDA DE ALUMINIO, 97 piezas



9024-TTS1	1	460 x 115 x 365	8.8
101-04-1, 101-045-1, 101-05-1, 101-055-1, 101-06-1, 101-07-1, 101-08-1, 101-09-1, 101-10-1, 101-11-1, 101-12-1, 101-13-1, 101-14-1			1/4
121-08-1, 121-10-1, 121-11-1, 121-12-1, 121-13-1, 121-14-1, 121-16-1, 121-17-1, 121-19-1, 121-21-1, 121-22-1			1/2
25-08-2, 25-09-2, 25-10-2, 25-11-2, 25-12-2, 25-13-2, 25-14-2, 25-17-2, 25-19-12			
407-5.5-125		409-1-100	
407-6.5-150		409-2-125	
105-70-1		105-50-1	
105-40-1		105-42-1	
105-22-1		105-24-1	
125-70-1		125-40-1	
125-23-1		125-25-1	
125-43-1			
46-8-F		475-32-1	
5-250C-1		604-160-1	
612-160-1		601-180-1	
625-180-1		634-250-1	
522-31-2		665-200-1	



## PORTAHERRAMIENTAS Y MALETINES

## ESTUCHE PORTA HERRAMIENTAS



- Gomas elásticas en base y tapa para una mejor distribución de las herramientas
- Doble cremallera
- Asa de goma suave
- Compartimento para documentación
- Medidas: 258 x 55 x 258 mm

9022-4-26	1	258 x 55 x 258	810

## BOLSOS DE TRANSPORTE DE HERRAMIENTA

## BOLSO PORTA-HERRAMIENTAS ABIERTA



- Bolso porta herramientas de fácil transporte y accesibilidad
- Base reforzada resistente al agua
- 12 bolsillos verticales en el lateral interiores y exteriores para una buena organización de la herramienta
- Panel interno despegable con 10 bolsillos y gomas para sujeción de la herramienta
- Velcro específico para el transporte de niveles y/o barras
- Mango de aluminio que refuerza toda la estructura con asa de foam para un mejor agarre
- Cinta para colgar del hombro ajustable en altura
- Fibra 600 x 300 que le proporciona resistencia y durabilidad
- Se entrega plegada

9022-1-19HB	1	490 x 240 x 350	32	20	1.5

## BOLSO PORTA-HERRAMIENTAS CERRADA



- Bolso con cremallera porta herramientas de fácil transporte y accesibilidad
- Base reforzada resistente al agua
- 10 bolsillos exteriores de diversos tamaños, algunos con tapa protectora y con clip para colocar flexómetros
- 14 bolsillos interiores para una mejor organización de la herramienta
- Cinta para el hombro ajustable para facilitar su transporte
- Fibra 600 x 300 que le proporciona resistencia y durabilidad

9022-2-16HB	1	420 x 240 x 300	24	18	1.2

## BOLSO PORTA-HERRAMIENTAS CERRADA



- Bolso con cremallera porta herramientas de fácil transporte y accesibilidad
- Base reforzada resistente al agua
- 17 bolsillos exteriores de diversos tamaños, algunos con tapa protectora y con clip para colocar flexómetros
- 14 bolsillos interiores para una mejor organización de la herramienta
- Cinta para el hombro ajustable para facilitar su transporte
- Fibra 600 x 300 que le proporciona resistencia y durabilidad

9022-2-19HB	1	490 x 240 x 370	35	20	1.5

**Mochila porta herramientas**



\* La mochila viene sin herramientas

- Alta capacidad de almacenaje con diferentes bolsillos y organizador de herramientas desmontable. 20 L, 16 kg
- Compartimento para portátil
- Organizador desmontable: 10 bolsillos para una mejor organización
- Bolsillo para smartphone en el compartimento frontal
- Poliéster 600D. Resistente y duradera

9022-BP1	1	300 x 450 x 175	20	16	1.93

**Mochila porta herramientas con ruedas**



\* La mochila viene sin herramientas

- Mango telescópico y 2 ruedas fijas para un fácil transporte
- Alta capacidad de almacenaje con diferentes bolsillos y organizador de herramientas desmontable. 26L, 20 kg
- Compartimento para portátil
- Organizador desmontable con 2 asas: 51 bolsillos para una mejor organización
- Poliéster 600D. Resistente y duradera
- Dos soportes delanteros para estabilizar el peso

9022-BPW	1	360 x 440 x 220	26	20	4

**JUEGOS DE DESTORNILLADORES**

**EXHIBIDOR DESTORNILLADORES**



- Display de 156 destornilladores
- Para tornillos planos y Phillips
- La forma del mango impide que la herramienta resbale
- Varilla de aleación de acero de alto rendimiento, cromado y templado

459A-156-P	1	156	400 x 100 x 800	18,7

407A-4-75; 407A-4-100; 407A-4-125; 407A-5-5-100; 407A-5-5-125; 407A-5-5-150; 407A-6-5-100; 407A-6-5-125; 407A-6-5-150; 407A-8-150

408A-4-125; 408A-4-200

409A-0-75; 409A-0-200; 409A-1-100; 409A-1-125; 409A-1-150; 409A-2-100; 409A-2-125; 409A-2-150; 409A-2-200; 409A-3-150

## LLAVES AJUSTABLES INGLESAS

## MOLETA CENTRAL

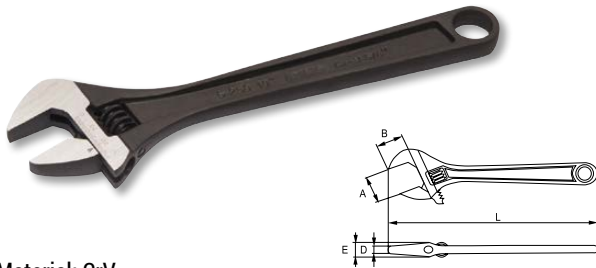

- Material: CrV
- Acabado: Fosfatada
- Dureza: 40-45 HRc
- Ángulo de cabeza 15° que proporciona mayor accesibilidad en espacios confinados
- UNE 16532, ISO 6787, DIN 3117
- -2 Envase industrial

Q	W	W	A mm	B mm	D mm	E mm	L mm	g
5-100-2	60	100 mm - 4"	13	13.5	3.5	9	115	60
5-150-2	50	150 mm - 6"	20	21	5.5	12	160	130
5-200-2	40	200 mm - 8"	24	26	7.5	13.5	205	250
5-250-2	30	250 mm - 10"	29	29.5	9	16	260	405
5-300-2	20	300 mm - 12"	36	36	11	19	310	650
5-375-2	1	375 mm - 15"	43	45	13	24	385	1.230
5-450-2	1	450 mm - 18"	57	53	15	27.5	465	2.000

## JUEGO 4 LLAVES AJUSTABLES INGLESAS FOSFATADAS



- Material: CrV
- Acabado: Fosfatada
- Dureza: 40-45 HRc
- Ángulo de cabeza 15° que proporciona mayor accesibilidad en espacios confinados
- UNE 16532, ISO 6787, DIN 3117

Q	W	X	W	g
5-4-W	1	4	50 x 330 x 110	1.500
5-150-2, 5-200-2, 5-250-2, 5-300-2				

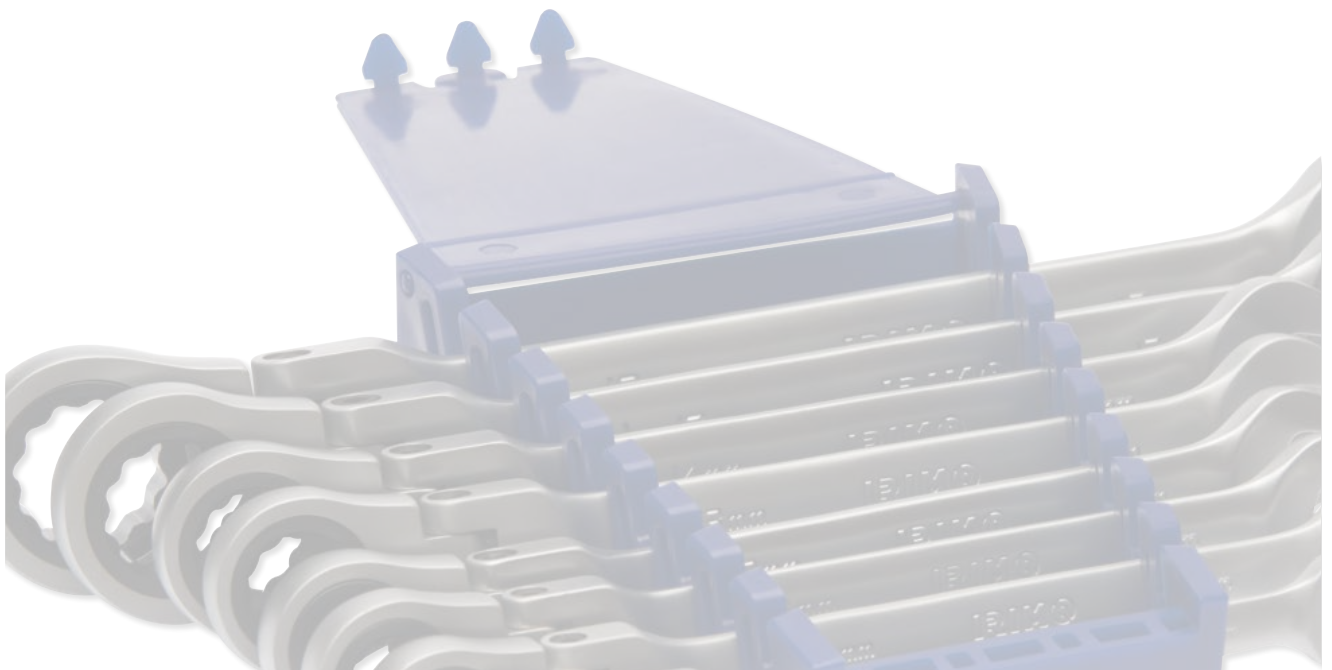



LLAVES COMBINADAS

LLAVES COMBINADAS EN MILÍMETROS



- Acero aleado de alto rendimiento cromado acabado mate
- Dureza: 42-50 HRc
- DIN 3113, ISO 1711-1, ISO 3318, ISO 691, ISO 7738
- -2 Envase industrial

Q	Icono	S mm	L mm	B1 mm	B2 mm	F mm	E mm	E1 mm	E2 mm	G mm	g
25-06-2	1	6	103	15.7	10.6	6.2	7.9	3.7	5.2	3	15
25-07-2	1	7	109	18	12.1	6.8	8.2	3.7	5.5	3	17
25-08-2	1	8	119	18.8	13.6	6.8	9.9	4.0	6	3.3	21
25-09-2	1	9	124	21	15.1	7.9	10.4	4.0	6.8	3.4	26
25-10-2	1	10	134	22.8	16.2	8.6	10.7	4.8	7	3.6	38
25-11-2	1	11	143	25.8	17.1	9.1	12.6	4.8	7.5	3.6	39
25-12-2	1	12	154	27.8	18.9	10	13.2	5.2	8	4.2	51
25-13-2	1	13	164	29.8	20.2	11.5	14.6	5.2	8.3	4.2	63
25-14-2	1	14	174	29.8	21.2	11.4	15.8	5.8	8.9	4.6	68
25-15-2	1	15	183	34.1	22.3	12.2	16.9	5.8	8.9	4.6	85
25-16-2	1	16	194	35.1	23.8	13.2	17.6	6.3	9.5	5	107
25-17-2	1	17	203	37.2	25.3	14.4	18.6	6.3	10	5	118
25-18-2	1	18	214	39.2	26.8	14.4	20.5	6.7	10.5	5.2	137
25-19-2	1	19	228	41.4	28.3	15.8	21.1	7.0	11.2	5.2	163
25-20-2	1	20	240	42.4	29.7	17.3	22.8	7.5	11.4	5.5	186
25-21-2	1	21	249.5	45.4	32.4	17.3	22.8	8.6	12.6	6	210
25-22-2	1	22	249.5	45.4	32.4	17.3	22.8	8.6	12.2	6	202
25-23-2	1	23	270	49.7	36.1	20.3	25	9.2	13.6	6.4	281
25-24-2	1	24	270	49.7	36.1	20.3	25	9.2	13.6	6.4	276
25-25-2	1	25	289.5	53.4	39.6	22.5	27.6	9.6	14.2	6.8	346
25-26-2	1	26	289.5	53.4	39.6	22.5	27.6	9.6	14.2	6.8	345
25-27-2	1	27	310	58.4	41.6	23.3	29.5	10.0	14.6	7.2	382
25-28-2	1	28	310	58.4	41.6	23.3	29.5	10.0	14.6	7.2	402
25-29-2	1	29	330	60.4	45.6	23.3	32.1	10.6	15.6	7.6	476
25-30-2	1	30	330	60.4	45.6	23.3	32.1	10.6	15.6	7.6	468

LLAVES COMBINADAS EN PULGADAS

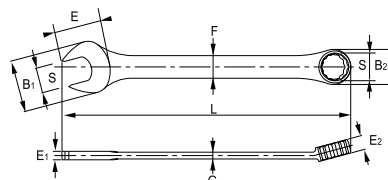

Q	Icono	S mm	L mm	B1 mm	B2 mm	F mm	E mm	E1 mm	E2 mm	G mm	g
25A-08-2	1	1/4"	103	15.9	10.6	6.6	7.9	3.7	5.2	3	15
25A-10-2	1	5/16"	119	19	13.6	7.2	9.9	4	6	3.3	21
25A-12-2	1	3/8"	124	21.2	15.1	8.3	10.4	4	6.8	3.4	26
25A-14-2	1	7/16"	143	26	17.1	9.5	12.6	4.8	7.5	3.6	39
25A-16-2	1	1/2"	164	30	20.2	11.9	14.6	5.2	8.3	4.2	63
25A-18-2	1	9/16"	174	30	21.2	11.8	15.8	5.8	8.9	4.6	68
25A-20-2	1	5/8"	194	35.3	23.8	13.6	17.6	6.3	9.5	5	107
25A-22-2	1	11/16"	214	39.4	26.8	14.8	20.5	6.7	10.5	5.2	137
25A-24-2	1	3/4"	228	41.6	28.3	16.2	21.1	7	11.2	5.2	163
25A-26-2	1	13/16"	249.5	45.4	32.4	17.3	22.8	8.6	12.6	6	210
25A-28-2	1	7/8"	249.5	45.4	32.4	17.3	22.8	8.6	12.6	6	210
25A-30-2	1	15/16"	270	49.7	36.1	20.3	25	9.2	13.6	6.4	281
25A-32-2	1	1"	289.5	53.4	39.6	22.5	27.6	9.6	14.2	6.8	346

JUEGO 8 LLAVES COMBINADAS



- Acero aleado de alto rendimiento cromado acabado mate
- Dureza: 42-50 HRc
- DIN 3113, ISO 1711-1, ISO 3318, ISO 691, ISO 7738

Q	Icono	Icono X	Icono X	Icono g
25-8-H	1	8	250 x 120 x 50	875
25-08-1, 25-10-1, 25-11-1, 25-13-1, 25-14-1, 25-17-1, 25-19-1, 25-22-1				

## LLAVES COMBINADAS

## JUEGO 12 LLAVES COMBINADAS



- Acero aleado de alto rendimiento cromado acabado mate
- Dureza: 42-50 HRc
- DIN 3113, ISO 1711-1, ISO 3318, ISO 691, ISO 7738

R		X		g
25-12-H	1	12	350 x 50 x 70	2.975
25-10-1, 25-11-1, 25-12-1, 25-13-1, 25-14-1, 25-17-1, 25-19-1, 25-22-1, 25-24-1, 25-27-1, 25-30-1, 25-32-1				

## LLAVES COMBINADAS CON CRIQUE

## LLAVE COMBINADA CON CRIQUE FIJO



- Acero aleado de alto rendimiento cromado acabado mate
- Dureza: 40-50 HRc
- -1 Envase individual

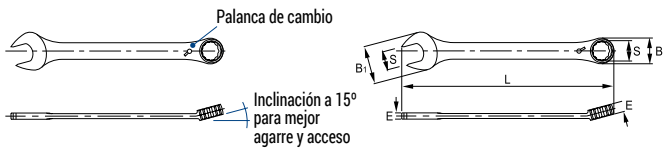

Carraca resistente sobrepasa ISO

R		S mm	B1 mm	B2 mm	E mm	L mm	g
18-06-1	1	6	15	14.3	4	128	27
18-07-1	1	7	16.4	16.8	4.4	138	35
18-08-1	1	8	18	18.3	4.8	140	38
18-09-1	1	9	20	20	4.8	150	48
18-10-1	1	10	22	21.5	5.1	160	57
18-11-1	1	11	24.5	23.5	5.5	165	67
18-12-1	1	12	26	25	5.9	170	82
18-13-1	1	13	28	26.4	6.4	180	95
18-14-1	1	14	30.8	28	6.7	190	113
18-15-1	1	15	33	30	7.3	200	130
18-16-1	1	16	24.5	31	7.8	210	158
18-17-1	1	17	37	33	8	225	180
18-18-1	1	18	39.5	35	8.2	235	213
18-19-1	1	19	40.8	36	8.4	245	233
18-21-1	1	21	44.8	42	9	290	343
18-22-1	1	22	44.8	42	9	290	345
18-24-1	1	24	52.8	48	9.7	332	503
18-27-1	1	27	56	53	10.8	359	550
18-30-1	1	30	62	58	11.2	404	750
18-32-1	1	32	65	62	12	424	900

## JUEGO 8 LLAVES COMBINADAS CON CRIQUE FIJO



- Acero aleado de alto rendimiento cromado acabado mate
- Dureza: 40-50 HRc

R		X		g
18-8-H	1	8	45 x 245 x 130	870
18-08-1, 18-10-1, 18-11-1, 18-12-1, 18-13-1, 18-14-1, 18-17-1, 18-19-1				

LLAVE COMBINADA CON CRIQUE ARTICULADO

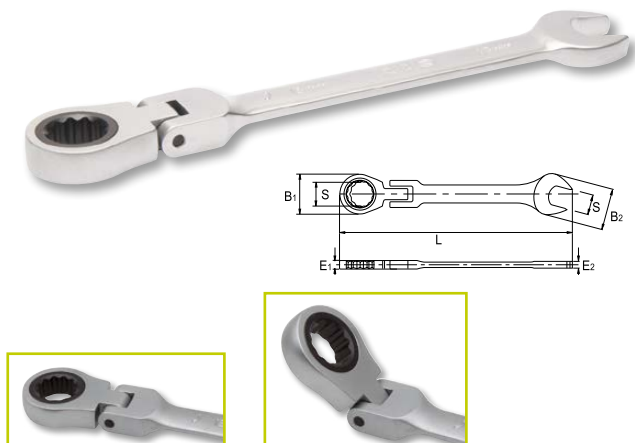

- Acero aleado de alto rendimiento cromado acabado mate
- Dureza: 40-50 HRC
- -1 Envase individual

Q	Icono	S mm	B1 mm	B2 mm	E1 mm	E2 mm	L mm	g
19-08-1	1	8	18.3	18	7.2	4.8	140	35
19-10-1	1	10	21.5	22	7.8	5.1	160	55
19-11-1	1	11	23.5	24.5	8.4	5.5	165	63
19-12-1	1	12	25	26	8.8	5.9	170	83
19-13-1	1	13	26.4	28	9.1	6.4	180	93
19-14-1	1	14	28	30.8	9.4	6.7	190	113
19-17-1	1	17	33	37	10.5	8	225	173
19-19-1	1	19	36.5	40.8	11.2	8.4	245	233

JUEGO 8 LLAVES DE CRIQUE CON CABEZA FLEXIBLE



- Acero aleado de alto rendimiento cromado acabado mate
- Dureza: 40-50 HRC

Q	Icono	S mm	B1 mm	B2 mm	E1 mm	E2 mm	L mm	g
19-8-H	1	8	45 x 240 x 140					850

19-08-1, 19-10-1, 19-11-1, 19-12-1, 19-13-1, 19-14-1, 19-17-1, 19-19-1

LLAVE UNIVERSAL

LLAVE UNIVERSAL 7 EN 1



- Llave universal adecuada para todas las cerraduras más comunes
- 1 llave para 7 aplicaciones diferentes
- Llave para liberación del aire de los radiadores en la parte central
- Para sistemas de electricidad, calefacción, ventilación y aire acondicionado además de aplicaciones de construcción
- Hecho en fundición de zinc, con cadena, adaptador y punta (1,2x7 mm y PH2)
- Dimensiones: 72x72 mm
- Embalaje en blíster

Q	Icono	S mm	B1 mm	B2 mm	E1 mm	E2 mm	L mm	g
71-UN7-1	1	1.2	PH-2	3-5	9	3-5	72x72	89

LLAVE UNIVERSAL 9 EN 1



- Llave universal para las formas más comunes
- 1 llave para 9 aplicaciones diferentes
- Cuadrado: 5,6,7-8 mm, Triangular: 9-10 mm
- Llave de dos sentidos: 6-9 mm
- Para sistemas de electricidad, calefacción, ventilación y aire acondicionado además de aplicaciones de construcción
- Hecho en fundición de zinc, con cadena, adaptador y punta (1,2x7 mm y PH2)
- Dimensiones: 90x62 mm
- Embalaje en blíster

Q	Icono	S mm	B1 mm	B2 mm	E1 mm	E2 mm	L mm	g
71-UN9-1	1	1.2	PH-2	5-7-8	9-10	9-10	90x62	87

## LLAVES DINAMOMÉTRICAS

### DINAMOMÉTRICA DE ZAFE AJUSTABLE CON CRIQUE



- Precisión: ± 4%
- Cabeza fija
- Crique reversible de 45 dientes con ángulo de acción 8°
- Mango de plástico para mayor confort
- ISO 6789

Modelo	Cabeza	Tamaño	Nm	Δ Nm	L mm	kg
070411	1	1/4"	4-20	0.050	275	0.5
070431	1	1/2"	25-125	0.25	420	0.9
070441	1	1/2"	40-200	0.5	460	1.0
070451	1	1/2"	65-335	0.5	520	1.2

### FUERZAS DE PRETENSADO Y PARES DE APRIETE RECOMENDADOS

Tamaño	Paso	Diámetro	Espesor	Sección	Coeficiente de rozamiento	CALIDAD DE TORNILLO															
						4,8		5,8		6,8		8,8		10,9		12,9					
						Pretensado N	Apriete Nm	Pretensado N	Apriete Nm	Pretensado N	Apriete Nm	Pretensado N	Apriete Nm	Pretensado N	Apriete Nm	Pretensado N	Apriete Nm				
M2	040	40	15	207	0,10	4480	0,15	610,6	0,19	732,7	0,23	976,9	0,31	1373,8	0,43	1648,6	0,52	1816,0			
M2,5	045	50	20	3,39	0,10	813,5	0,31	1016,9	0,39	1220,2	0,47	1627,0	0,63	2288,0	0,88	2745,6	1,06	3051,0			
M3	050	55	25	5,03	0,10	1219,9	0,54	1524,9	0,68	1829,9	0,82	2439,9	1,09	3431,0	1,53	4117,2	1,84	4512,0			
M3,5	060	60	-	6,78	0,10	1638,2	0,84	2047,8	1,05	2457,3	1,26	3276,4	1,68	4607,5	2,36	5528,9	2,84	6172,0			
M4	070	70	30	8,78	0,10	21154	1,25	2644,3	1,56	3173,1	1,88	4230,8	2,50	5949,6	3,52	7139,5	4,22	7884,0			
M5	080	80	40	14,20	0,10	34616	2,46	4327,0	3,08	5192,3	3,70	6923,1	4,93	9735,7	6,93	11682,8	8,32	12624,0			
M6	100	100	50	20,10	0,10	48747	4,24	6093,4	5,30	7312,1	6,35	9749,4	8,47	13710,1	11,92	16452,2	14,30	15816,0			
M7	100	110	-	28,90	0,10	71345	6,97	8918,2	8,71	10701,8	10,45	14269,1	13,94	20065,9	19,60	24079,1	23,52	25812,0			
M8	125	130	60	36,60	0,10	89471	10,20	11833,9	12,75	13420,7	15,30	17894,2	20,41	25163,7	28,70	30196,5	34,44	36456,0			
M10	150	160	80	58,00	0,10	142445	20,11	17805,6	25,14	21366,8	30,16	28489,0	40,22	40062,7	56,56	48075,3	67,87	73512,0			
M12	175	180	100	84,30	0,10	207666	34,43	25958,3	43,03	31149,9	51,64	41533,2	68,86	58406,1	96,83	70087,3	116,20	138516,0			
M14	200	210	120	115,00	0,10	283899	54,77	35487,4	68,46	42584,9	62,15	79846,6	109,53	154182,1	154,03	184848,0	184,84	228036,0			
M16	200	240	140	157,00	0,10	392421	85,14	49052,7	106,43	58863,2	127,72	78484,3	170,29	211368,5	239,47	332442,2	287,36	357096,0			
M18	250	270	140	192,00	0,10	47533,0	117,48	59416,3	146,85	71299,6	176,22	95066,1	234,96	133686,7	330,41	160424,1	396,49	4899,2			
M20	250	300	170	245,00	0,10	61238,0	166,08	76547,5	207,61	91857,0	249,13	122476,0	332,17	172231,9	467,11	206678,2	560,54	696,56			
M22	250	340	170	303,00	0,10	76305,2	227,22	95381,5	284,02	114457,8	340,82	152610,4	454,43	214608,3	639,05	257530,0	766,85	957,80			
M24	300	360	190	353,00	0,10	88232,4	287,16	110290,5	358,94	132348,6	430,73	176646,9	574,31	248153,7	807,63	297784,4	969,15	1204,33			
M27	300	410	190	459,00	0,10	115778,8	420,04	144723,5	525,05	173668,2	630,06	231557,6	840,08	325627,9	1181,36	390753,4	1417,63	1772,15			
M30	350	460	220	561,00	0,10	140999,5	572,83	176249,4	716,03	211499,3	859,24	281999,0	1145,65	396561,1	1611,08	475873,4	1933,29	2411,39			
M33	350	500	220	694,00	0,10	175618,1	774,65	219522,6	968,32	263427,1	1161,98	351236,2	1549,31	493925,8	2178,72	592711,0	2614,46	3275,19			
M36	400	550	240	817,00	0,10	206081,7	996,60	257602,2	1248,25	309122,6	1497,89	412163,5	1997,19	579604,8	2808,55	695525,8	3370,26	4213,37			
M39	400	600	270	976,00	0,10	247520,0	1291,81	309400,0	1614,77	371279,9	1937,21	495039,9	2583,63	696149,8	3633,23	835379,8	4359,88	5470,75			
M42	450	650	-	1120,00	0,10	283225,0	1601,25	354031,2	2001,57	424837,4	2401,88	566449,9	3202,51	796570,1	4503,53	955884,2	5404,23	6768,44			
M45	450	700	320	1310,00	0,10	332751,5	2005,51	415939,4	2506,89	499127,3	3008,26	665503,0	4011,02	935863,6	5640,50	1123036,0	6768,60	8503,47			
M48	500	750	-	1470,00	0,10	372429,3	2406,51	465536,6	3008,14	558644,0	3609,77	744858,6	4813,03	1047457,0	6768,32	1266942,0	8121,98	10186,14			
M52	500	800	360	1760,00	0,10	448108,9	3099,96	560136,1	3874,95	672163,4	4649,93	896217,8	6199,91	1260306,0	8718,63	1512368,0	10462,36	13164,25			
M56	550	850	410	2030,00	0,10	516202,9	3838,14	645253,6	4797,68	774304,4	5757,21	1032406,0	7676,29	1451821,0	10794,78	1742185,0	12953,73	16282,36			
M60	550	900	-	2360,00	0,10	602498,5	4754,64	753123,1	5943,30	903747,8	7131,96	1204997,0	9509,28	1694527,0	13372,43	2033432,0	16046,91	20225,39			
M64	600	950	460	2680,00	0,10	683339,5	5746,17	854174,4	7182,71	1025009,0	8619,25	1366679,0	11492,34	1921892,0	16161,10	2306271,0	19393,32	24418,58			
M68	600	1000	-	3060,00	0,10	782799,9	6939,64	978499,8	8674,55	1174200,0	10409,46	1565600,0	13879,28	2201625,0	19517,74	2641950,0	23421,29	29559,06			

**BOCALLAVES 1/4"**

**BOCALLAVES 1/4" HEXAGONAL**

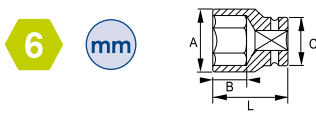

- Bocallaves en milímetros, diseño hexagonal
- Acero aleado Cromo Vanadio
- Acabado cromado brillante
- Perfil NPP
- DIN 3120, DIN 3124

R			A mm	B mm	C mm	L mm	g
101-04-1	5	4	6.9	9.0	12.0	25.0	11
101-045-1	5	4.5	7.5	9.0	12.0	25.0	11
101-05-1	5	5	8.2	9.0	12.0	25.0	11
101-055-1	5	5.5	8.8	9.0	12.0	25.0	12
101-06-1	5	6	9.4	9.0	12.0	25.0	11
101-07-1	5	7	11.0	9.0	12.0	25.0	13
101-08-1	5	8	12.0	12.0	12.0	25.0	13
101-09-1	5	9	13.0	12.0	13.0	25.0	15
101-10-1	5	10	14.0	12.0	12.6	25.0	21
101-11-1	5	11	16.0	12.0	14.0	25.0	24
101-12-1	5	12	17.0	12.0	14.8	25.0	26
101-13-1	5	13	18.0	12.0	15.8	25.0	28
101-14-1	5	14	20.0	12.0	17.4	25.0	39



R			A mm	B mm	C mm	L mm	g
101A-05-1	5	5/32"	6.9	8.5	12.0	25.0	10
101A-06-1	5	3/16"	7.5	8.5	12.0	25.0	10
101A-07-1	5	7/32"	8.8	9.5	12.0	25.0	11
101A-08-1	5	1/4"	9.4	9.5	12.0	25.0	11
101A-09-1	5	9/32"	11.0	10.5	12.0	25.0	13
101A-10-1	5	5/16"	12.0	10.5	12.0	25.0	12
101A-11-1	5	11/32"	13.0	10.5	12.0	25.0	14
101A-12-1	5	3/8"	14.0	10.5	12.6	25.0	18
101A-14-1	5	7/16"	16.0	11.5	14.0	25.0	23
101A-16-1	5	1/2"	18.0	11.5	15.8	25.0	29
101A-18-1	5	9/16"	20.0	11.5	17.4	25.0	37

**BOCALLAVES 1/4" TORX®**

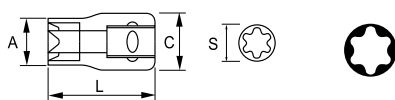

**BOCALLAVES 1/4" HEXAGONAL, SERIE LARGA**

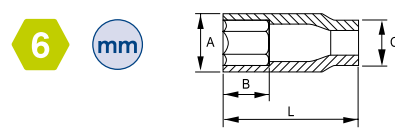

- Bocallaves en milímetros, diseño hexagonal
- Acero aleado Cromo Vanadio
- Acabado cromado brillante
- Perfil NPP
- DIN 3120

R			A mm	B mm	C mm	L mm	g
103-04-1	5	4	6.9	12.0	12.0	50.0	21
103-045-1	5	4.5	7.5	12.0	12.0	50.0	20
103-05-1	5	5	8.2	12.0	12.0	50.0	21
103-055-1	5	5.5	8.8	12.0	12.0	50.0	22
103-06-1	5	6	9.4	12.0	12.0	50.0	22
103-07-1	5	7	11.0	24.0	12.0	50.0	26
103-08-1	5	8	12.0	24.0	10.9	50.0	29
103-09-1	5	9	13.0	24.0	11.6	50.0	30
103-10-1	5	10	14.0	24.0	13.0	50.0	39
103-11-1	5	11	16.0	24.0	14.2	50.0	44
103-12-1	5	12	17.0	24.0	15.0	50.0	49
103-13-1	5	13	18.0	24.0	16.0	50.0	55
103-14-1	5	14	20.0	24.0	17.0	50.0	65

## BOCALLAVES 1/4" CON PUNTA

### PUNTA PLANA



- Punta fabricada con acero especial S2
- DIN 3120

R			A mm	B mm	L mm	g
107-0840-1	5	0.8 x 4	11.8	20.0	37.5	15
107-1055-1	5	1 x 5.5	11.8	20.0	37.5	15
107-1280-1	5	1.2 x 8	11.8	20.0	37.5	16

### PUNTA PHILLIPS



- Punta fabricada con acero especial S2
- DIN 3120

R			A mm	B mm	L mm	g
107-PH1-1	5	PH-1	11.8	20.0	37.5	15
107-PH2-1	5	PH-2	11.8	20.0	37.5	15
107-PH3-1	5	PH-3	11.8	20.0	37.5	16

### PUNTA POZIDRIV



- Punta fabricada con acero especial S2
- DIN 3120

R			A mm	B mm	L mm	g
107-PZ1-1	5	PZ-1	11.8	20.0	37.5	15
107-PZ2-1	5	PZ-2	11.8	20.0	37.5	15
107-PZ3-1	5	PZ-3	11.8	20.0	37.5	16

### PUNTA HEXAGONAL



- Punta fabricada con acero especial S2
- DIN 3120

R			A mm	B mm	L mm	g
107-H3-1	5	3	11.8	20.0	37.5	15
107-H4-1	5	4	11.8	20.0	37.5	15
107-H5-1	5	5	11.8	20.0	37.5	16
107-H6-1	5	6	11.8	20.0	37.5	17
107-H8-1	5	8	11.8	20.0	37.5	19

### PUNTA TORX®



- Punta fabricada con acero especial S2
- DIN 3120

R			S mm	A mm	C mm	L mm	g
107-T08-1	5	T8	2.3	11.8	20.0	37.5	15
107-T09-1	5	T9	2.5	11.8	20.0	37.5	15
107-T10-1	5	T10	2.7	11.8	20.0	37.5	15
107-T15-1	5	T15	3.3	11.8	20.0	37.5	15
107-T20-1	5	T20	3.8	11.8	20.0	37.5	15
107-T25-1	5	T25	4.4	11.8	20.0	37.5	15
107-T27-1	5	T27	5.0	11.8	20.0	37.5	16
107-T30-1	5	T30	5.5	11.8	20.0	37.5	16
107-T40-1	5	T40	6.6	11.8	20.0	37.5	16

ACCESORIOS 1/4"

CRIQUE TIPO PERA

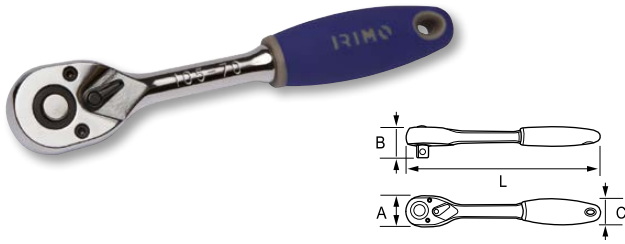

- 72 dientes / Ángulo de acción 5°
- Acabado cromado brillante
- Botón de rápida liberación
- Mango bicomponente
- DIN 3120, DIN 3122

Q	Icono	A mm	B mm	C mm	L mm	g
105-70-1	5	28	25	23	152	151

JUEGO DE BOCALLAVES 1/4" EN RAIL, 11 piezas



- Juego de bocallaves de 1/4"
- Juego de bocallaves 11 piezas
- Bocallaves hexagonales, medidas métricas
- Acabado brillante cromado
- DIN 3120, DIN 3124, DIN 3122
- Presentación para colgar

Q	Icono	Icono X	Icono X	g
109-11-4	5	11	232 x 60 x 15	250

101-04-1, 101-05-1, 101-06-1, 101-07-1, 101-08-1, 101-09-1, 101-10-1, 101-11-1, 101-12-1, 101-13-1, 101-14-1

JUEGO DE 1/4" CRIQUE + 11 BOCALLAVES



- Juego de bocallaves 1/4", 13 piezas
- Bocallaves hexagonales, mm
- Acabado cromado brillante
- DIN 3120, DIN 3124, DIN 3122
- \* Suministrado en display si se piden 12 unidades

Q	Icono	Icono X	Icono X	g
109-13-4	8	13	254 x 70 x 30	460

105-70-1, 105-24-1, 101-04-1, 101-05-1, 101-06-1, 101-07-1, 101-08-1, 101-09-1, 101-10-1, 101-11-1, 101-12-1, 101-13-1, 101-14-1

ALARGADERAS



- DIN 3120, DIN 3122

Q	Icono	A mm	B mm	L mm	g
105-22-1	5	8.1	12.2	50	20
105-24-1	5	8.1	12.2	100	38
105-26-1	5	8.1	12.2	150	65

MANGO CORREDIZO EN T

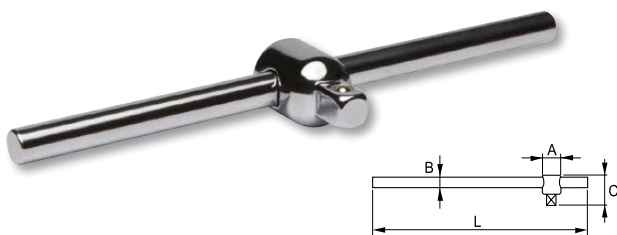

- DIN 3120, DIN 3122

Q	Icono	A mm	B mm	C mm	L mm	g
105-42-1	5	13.5	6.0	24	115	45

ALARGADERA FLEXIBLE

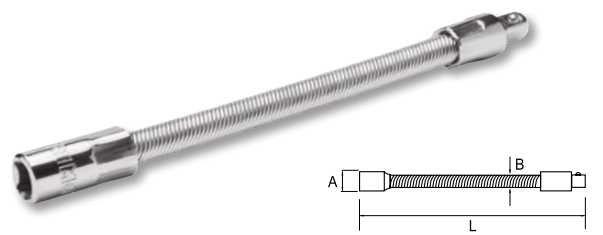

- DIN 3120

Q	Icono	A mm	B mm	L mm	g
105-28-1	5	12.5	8	148	57

MANGO CUADRADO MACHO

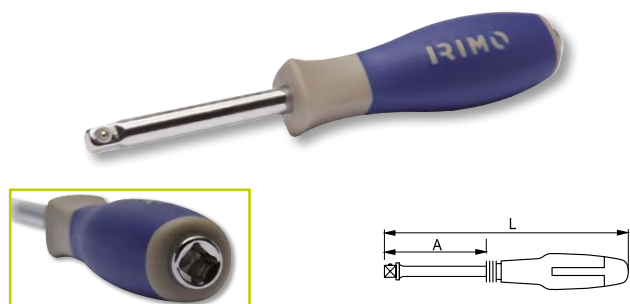

- Cuadradillo hembra 1/4" en la cabeza
- DIN 3120

Q	📦	A mm	L mm	📏	📏	g
105-50-1	5	61	150	1/4"	1/4"	88

ARTICULACIÓN UNIVERSAL



- DIN 3120, DIN 3122

Q	📦	A mm	L mm	g
105-40-1	5	13.8	38.0	27

AUMENTADOR



- Aumentador de 1/4" a 3/8"
- DIN 3120, DIN 3122

Q	📦	A mm	L mm	g
105-46-1	5	12.0	26.0	31

VASO PORTA PUNTAS 1/4"



- Hembra cuadrado 1/4" a hembra hex 1/4"
- DIN 3120

Q	📦	A mm	L mm	g
105-48-1	5	11.9	25.0	12

JUEGO BOCALLAVES 1/4"

JUEGO DE BOCALLAVES Y PUNTAS DE 1/4", 23 piezas

1/4" mm



- 23 bocallaves de 1/4" y conjunto de puntas DIN 3120 y DIN 3124
- Par de crique según DIN 3122
- Crique especial hexagonal de 1/4"; Reversible; 60 dientes; L = 90 mm
- Mango de crique bi-material
- Caja de plástico ABS
- Incluye clip para el cinturón
- El crique se vende como repuesto: SP121

Q	📦	📏	📏	g
109-23-4	1	23	110x75x45	340
101-06-1, 101-07-1, 101-08-1, 101-10-1, 101-11-1, 101-13-1			1/4"	
475A-25-1			🔩	
475-PH1-1, 475-PH2-1			🔩	
475-PZ1-1, 475-PZ2-1			🔩	
475-4-1, 475-6.0-1			🔩	
475-H3-1, 475-H4-1, 475-H5-1, 475-H6-1			🔩	
475-T10-1, 475-T15-1, 475-T20-1, 475-T25-1, 475-T30-1			🔩	
SP121			🔩	



## JUEGO BOCALLAVES 1/4"

### JUEGO BOCALLAVES 1/4", 19 piezas



- Bocallaves Hex mm
- Acero aleado Cromo Vanadio
- Acabado cromado brillante
- DIN 3120, DIN 3124 y DIN 3122
- Caja fabricada en polietileno de alta densidad y resistente

109-19-4	10	19	260x185x55	1.100
105-40-1		105-70-1		
105-42-1		105-50-1		
105-22-1		105-26-1		
101-04-1, 101-045-1, 101-05-1, 101-055-1, 101-06-1, 101-07-1, 101-08-1, 101-09-1, 101-10-1, 101-11-1, 101-12-1, 101-13-1, 101-14-1				

### JUEGO BOCALLAVES 1/4", 35 piezas



- Juego bocallaves 35 piezas
- Bocallaves Hex mm
- Acabado cromado brillante
- DIN 3120, DIN 3124 y DIN 3122
- Caja fabricada en polietileno de alta densidad y resistente

109-35-4	1	35	250 x 170 x 60	1.200
105-48-1		105-70-1		
105-42-1		105-50-1		
105-22-1		105-40-1		
105-24-1				
101-04-1, 101-045-1, 101-05-1, 101-055-1, 101-06-1, 101-07-1, 101-08-1, 101-09-1, 101-10-1, 101-11-1, 101-12-1, 101-13-1				
040001, 040011, 040021				
475-PH1-1, 475-PH2-1, 475-PH3-1				
475-PZ1-1, 475-PZ2-1, 475-PZ3-1				
475-4-1, 475-6.0-1				
475-H3-1, 475-H4-1, 475-H5-1, 475-H6-1				

## JUEGO BOCALLAVES 3/8"

### JUEGO BOCALLAVES 3/8", 18 piezas



- Juego bocallaves 18 piezas
- Bocallaves Hex mm
- Acabado cromado brillante
- DIN 3120, DIN 3124 y DIN 3122
- Caja fabricada en polietileno de alta densidad y resistente

119-18-4	1	18	320 x 250 x 75	3.250
112-07-1, 112-08-1, 112-10-1, 112-11-1, 112-12-1, 112-13-1, 112-14-1, 112-15-1, 112-16-1, 112-17-1, 112-19-1, 112-21-1, 112-22-1				
115-70-1				
115-20-1, 115-22-1				
115-40-1				
115-43-1				

## BOCALLAVES 1/2"

### BOCALLAVES 1/2" HEXAGONAL

6 mm

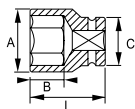

- Bocallaves en milímetros, diseño hexagonal
- Acero aleado Cromo Vanadio
- Acabado cromado brillante
- Perfil NPP
- DIN 3120, DIN 3124

R			A mm	B mm	C mm	L mm	g
121-08-1	5	8	14.8	13.0	22.0	38.0	50
121-09-1	5	9	15.3	13.0	22.0	38.0	48
121-10-1	5	10	15.3	13.0	22.0	38.0	49
121-11-1	5	11	16.5	13.0	22.0	38.0	50
121-12-1	5	12	17.8	13.0	22.0	38.0	52
121-13-1	5	13	19.0	13.0	22.0	38.0	54
121-14-1	5	14	20.3	13.0	22.0	38.0	56
121-15-1	5	15	22.0	17.8	20.5	38.0	57
121-16-1	5	16	22.0	17.8	20.5	38.0	71
121-17-1	5	17	24.0	17.8	21.9	38.0	72
121-18-1	5	18	25.0	17.8	22.9	38.0	90
121-19-1	5	19	26.0	17.8	22.9	38.0	84
121-20-1	5	20	28.0	17.8	23.9	38.0	87
121-21-1	5	21	28.0	17.8	23.9	38.0	95
121-22-1	5	22	30.0	17.8	26.1	38.0	97
121-23-1	5	23	32.0	17.8	28.1	38.0	103
121-24-1	5	24	32.0	17.8	28.1	38.0	109
121-25-1	5	25	34.0	17.8	29.1	40.0	146
121-26-1	5	26	34.0	17.8	29.1	42.0	192
121-27-1	5	27	36.0	17.8	30.1	42.0	211
121-28-1	5	28	38.0	17.8	32.1	42.0	212
121-30-1	5	30	40.0	17.8	34.1	44.0	214
121-32-1	5	32	42.0	17.8	36.1	44.0	217

### BOCALLAVES 1/2" ESTRIADO

12 mm

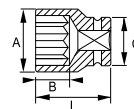

- Bocallaves en milímetros, diseño estriado
- Acero aleado Cromo Vanadio
- Acabado cromado brillante
- Perfil NPP
- DIN 3120, DIN 3124

R			A mm	B mm	C mm	L mm	g
122-08-1	5	8	14.8	13.0	22.0	38.0	50
122-09-1	5	9	15.3	13.0	22.0	38.0	48
122-10-1	5	10	15.3	13.0	22.0	38.0	49
122-11-1	5	11	16.5	13.0	22.0	38.0	50
122-12-1	5	12	17.8	13.0	22.0	38.0	52
122-13-1	5	13	19.0	13.0	22.0	38.0	54
122-14-1	5	14	20.3	13.0	22.0	38.0	56
122-15-1	5	15	22.0	17.8	20.5	38.0	57
122-16-1	5	16	22.0	17.8	20.5	38.0	71
122-17-1	5	17	24.0	17.8	21.9	38.0	72
122-18-1	5	18	25.0	17.8	22.9	38.0	90
122-19-1	5	19	26.0	17.8	22.9	38.0	84
122-20-1	5	20	28.0	17.8	23.9	38.0	87
122-21-1	5	21	28.0	17.8	23.9	38.0	95
122-22-1	5	22	30.0	17.8	26.1	38.0	97
122-23-1	5	23	32.0	17.8	28.1	38.0	103
122-24-1	5	24	32.0	17.8	28.1	38.0	109
122-27-1	5	27	36.0	17.8	30.1	42.0	211
122-30-1	5	30	40.0	17.8	34.1	44.0	214
122-32-1	5	32	42.0	17.8	36.1	44.0	217

12 in

R			A mm	B mm	C mm	L mm	g
122A-12-1	5	3/8"	15.5	13.0	22.0	38.0	45
122A-14-1	5	7/16"	16.7	13.0	22.0	38.0	49
122A-16-1	5	1/2"	19.2	13.0	22.0	38.0	54
122A-18-1	5	9/16"	20.5	13.0	22.0	38.0	55
122A-20-1	5	5/8"	22.0	17.8	20.6	38.0	69
122A-22-1	5	11/16"	24.0	17.8	21.9	38.0	71
122A-24-1	5	3/4"	26.0	17.8	22.9	38.0	75
122A-26-1	5	13/16"	28.0	17.8	23.9	38.0	76
122A-28-1	5	7/8"	30.0	17.8	26.1	38.0	88
122A-30-1	5	15/16"	32.0	17.8	28.1	38.0	104
122A-34-1	5	1.1/16"	36.0	17.8	30.1	42.0	141
122A-38-1	5	1.3/16"	40.0	17.8	34.1	44.0	214
122A-40-1	5	1.1/4"	42.0	17.8	36.1	44.0	233

## BOCALLAVES 1/2"

### BOCALLAVES 1/2" TORX®

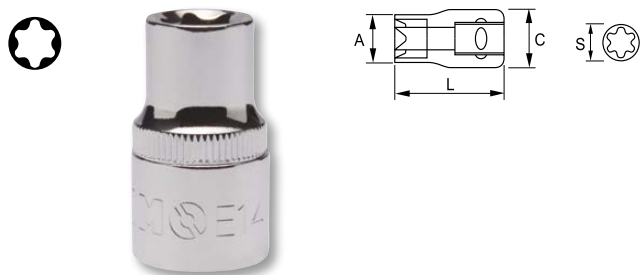

• DIN 3120

R			S mm	A mm	C mm	L mm	g
126-10-1	5	E-10	9.4	14.7	22.0	38.0	55
126-12-1	5	E-12	11.1	16.0	22.0	38.0	57
126-14-1	5	E-14	12.9	17.0	22.0	38.0	59
126-16-1	5	E-16	14.7	22.0	20.1	38.0	65
126-18-1	5	E-18	16.6	24.0	21.8	38.0	77
126-20-1	5	E-20	18.4	24.0	21.8	38.0	73

### BOCALLAVES 1/2" CON PUNTA

#### PUNTA HEXAGONAL



• DIN 3120 / ISO 1174

R			A mm	B mm	L mm	g
180-05-1	5	5	21.8	22	60	71
180-06-1	5	6	21.8	22	60	72
180-07-1	5	7	21.8	22	60	72
180-08-1	5	8	21.8	22	60	73
180-10-1	5	10	21.8	22	60	81
180-12-1	5	12	21.8	22	60	89
180-14-1	5	14	21.8	22	60	96
180-17-1	5	17	23.8	22	60	100

#### PUNTA TORX®



• DIN 3120 / ISO 1174

R			S mm	A mm	B mm	L mm	g
183-20-1	5	T20	3.84	21.8	22	60	69
183-25-1	5	T25	4.40	21.8	22	60	69
183-27-1	5	T27	4.96	21.8	22	60	70
183-30-1	5	T30	5.49	21.8	22	60	70
183-40-1	5	T40	6.60	21.8	22	60	70
183-45-1	5	T45	7.77	21.8	22	60	70
183-50-1	5	T50	8.79	21.8	22	60	71
183-55-1	5	T55	11.17	21.8	22	60	76
183-60-1	5	T60	13.20	21.8	22	60	81

#### PUNTA XZN



• DIN 3120 / ISO 1174

R			A mm	B mm	L mm	g
185-08-1	5	M 8	21.8	22	60	69
185-10-1	5	M 10	21.8	22	60	77
185-12-1	5	M 12	21.8	22	60	85

**JUEGO 9 BOCALLAVES CON PUNTA 1/2" HEXAGONAL**



- Juego de bocallaves con punta 1/2", 9 piezas
- Puntas hexagonales, mm
- Bocallaves: Acabado cromado brillante
- Puntas: fosfatadas
- DIN 3120 / ISO 1174
- Caja fabricada en polietileno de alta densidad y resistente

129-9H-4	1	9	55 x 200 x 160	1.080
180-04-1, 180-05-1, 180-06-1, 180-07-1, 180-08-1, 180-10-1, 180-12-1, 180-14-1, 180-17-1				

**JUEGO 9 BOCALLAVES CON PUNTA TORX® 1/2"**



- Juego de bocallaves con punta 1/2", 9 piezas
- Puntas TORX®
- Bocallaves: Acabado cromado brillante
- Puntas: fosfatadas
- DIN 3120 / ISO 1174
- Caja fabricada en polietileno de alta densidad y resistente

129-9T-4	1	9	55 x 200 x 160	1.140
183-20-1, 183-25-1, 183-27-1, 183-30-1, 183-40-1, 183-45-1, 183-50-1, 183-55-1, 183-60-1				

**ACCESORIOS 1/2"**

**CRIQUE TIPO PERA**

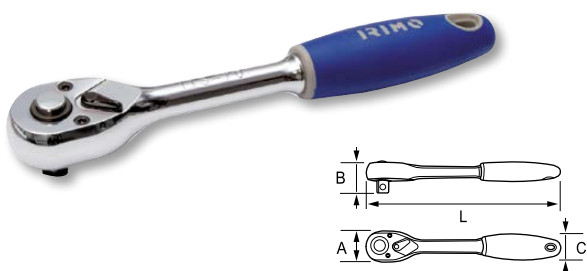

- 72 dientes / Ángulo de acción 5°
- Acabado cromado brillante
- Botón de rápida liberación
- Mango bicomponente
- DIN 3122/3120

		A mm	B mm	C mm	L mm	
125-70-1	5	42	41	36	262	591

**JUEGO DE BOCALLAVES 1/2" EN RAIL, 10 piezas**



- Juego de bocallaves de 1/2"
- Juego de bocallaves 10 piezas
- Bocallaves hexagonales, medidas métricas
- Acabado brillante cromado
- DIN 3120, DIN 3124, DIN 3122
- Presentación para colgar

129-10-4	5	10	360 x 90 x 15	800

121-10-1, 121-12-1, 121-13-1, 121-14-1, 121-16-1, 121-17-1, 121-19-1, 121-21-1, 121-22-1, 121-24-1

ACCESORIOS 1/2"

JUEGO DE 1/2" CRIQUE + 10 BOCALLAVES

1/2" mm



- Juego de bocallaves 12 piezas
- Bocallaves hexagonales, mm
- Acabado cromado brillante
- DIN 3120, DIN 3124, DIN 3122
- \* Suministrado en display si se piden 8 unidades

R	Icono	Icono	Icono	g
129-12-4	8	12	330 x 100 x 50	1.600
125-70-1		125-23-1		
121-10-1, 121-12-1, 121-13-1, 121-14-1, 121-16-1, 121-17-1, 121-19-1, 121-21-1, 121-22-1, 121-24-1				

ALARGADERAS

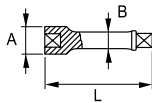

- DIN 3120, DIN 3122

R	Icono	A mm	B mm	L mm	g
125-22-1	5	22.4	15.7	75	120
125-23-1	5	22.4	15.7	125	193
125-25-1	5	22.4	15.7	250	380

MANGO ARTICULADO

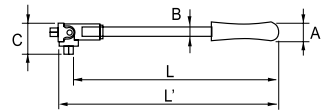

- DIN 3120

R	Icono	A mm	B mm	C mm	L' mm	L mm	g
125-52-1	5	35	12	40	375	355.0	692

MANGO CORREDIZO EN T

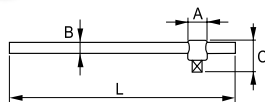

- DIN 3120, DIN 3122

R	Icono	A mm	B mm	C mm	L mm	g
125-42-1	5	23.5	13.5	45	250	272

CABEZA MANGO CORREDIZO

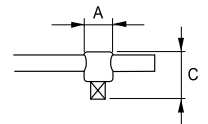

- DIN 3120

R	Icono	A mm	C mm	g
125-43-1	5	24.0	44	73

REDUCTOR

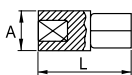

- Adaptador reductor 1/2" a 3/8"
- DIN 3120, DIN 3122

E		A mm	L mm	g
125-46-1	5	22.0	35.5	45

AUMENTADOR

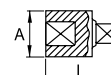

- Aumentador de 1/2" a 3/4"
- DIN 3120, DIN 3122

E		A mm	L mm	g
125-44-1	5	25.0	50.0	140

MANGO ACODADO

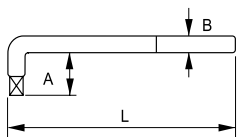

- DIN 3120, DIN 3122

E		A mm	B mm	L mm	g
125-60-1	5	46	14	250	456

BOCALLAVES SACABUJÍAS

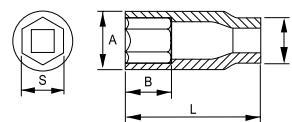

E		S mm	A mm	B mm	C mm	L mm	g
123731A	10	5/8" - 16	22,8	16,1	22,8	82,5	100
123781A	10	13/16" - 21	28,3	20,1	24,3	82,5	140

ARTICULACIÓN UNIVERSAL

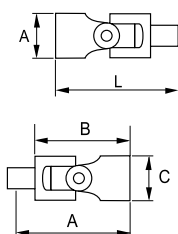

- DIN 3120, DIN 3122

E		A mm	B mm	L mm	g
125-40-1	5	23.8	72.0	146	

VASO PORTA PUNTAS 5/16"



- Cuadrado hembra 1/2" a hex hembra 5/16"
- DIN 3120

E		A mm	L mm	g
125-48-1	5	17.0	38.5	56

## JUEGO BOCALLAVES 1/2"

### JUEGO BOCALLAVES 1/2", 23 piezas



- Juego de bocallaves 23 piezas
- Bocallaves Hex mm
- Acabado cromado brillante
- DIN 3120, DIN 3124 y DIN 3122
- Caja fabricada en polietileno de alta densidad y resistente
- Cierres metálicos

129-23-4	1	23	320x250x75	3.500
125-70-1			125-43-1	
125-25-1			125-23-1	
125-40-1				
121-08-1, 121-10-1, 121-12-1, 121-13-1, 121-14-1, 121-16-1, 121-17-1, 121-19-1, 121-20-1, 121-21-1, 121-22-1, 121-23-1, 121-24-1, 121-26-1, 121-27-1, 121-28-1, 121-30-1, 121-32-1				

### JUEGO DE BOCALLAVES Y LLAVES 1/2", 33 piezas



- Juego de bocallaves y llaves de 33 piezas
- Bocallaves hexagonales, mm
- Acabado cromado brillante
- DIN 3120, DIN 3124, DIN 3122, ISO 10102
- Caja fabricada en polietileno de alta densidad y resistente
- Caja con cierres metálicos

129-33W-4	1	33	320x250x75	5.020
125-70-1			125-43-1	
125-25-1			125-23-1	
125-40-1				
25-08-1, 25-09-1, 25-10-1, 25-11-1, 25-12-1, 25-13-1, 25-14-1, 25-15-1, 25-17-1, 25-19-1				
121-08-1, 121-10-1, 121-12-1, 121-13-1, 121-14-1, 121-16-1, 121-17-1, 121-19-1, 121-20-1, 121-21-1, 121-22-1, 121-23-1, 121-24-1, 121-26-1, 121-27-1, 121-28-1, 121-30-1, 121-32-1				

**JUEGO BOCALLAVES MIXTO 1/4"-1/2",  
58 piezas**



- Juego de bocallaves 58 piezas
- Bocallaves Hex mm
- Acabado cromado brillante
- DIN 3120, DIN 3124 y DIN 3122
- Caja fabricada en polietileno de alta densidad y resistente
- Cierres metálicos

1	2	3	4	5
129-58-4	1	58	380x280x80	4.750
105-50-1		105-70-1		
105-42-1		105-40-1		
105-22-1		105-24-1		
125-70-1		125-43-1		
125-25-1		125-40-1		
125-23-1				
101-04-1, 101-045-1, 101-05-1, 101-055-1, 101-06-1, 101-07-1, 101-08-1, 101-09-1, 101-10-1, 101-11-1, 101-12-1, 101-13-1				
121-08-1, 121-10-1, 121-12-1, 121-13-1, 121-14-1, 121-16-1, 121-17-1, 121-19-1, 121-20-1, 121-21-1, 121-22-1, 121-23-1, 121-24-1, 121-26-1, 121-27-1, 121-28-1, 121-30-1, 121-32-1				
040001, 040011, 040021				
475-PH1-1, 475-PH2-1, 475-PH3-1				
475-PZ1-1, 475-PZ2-1, 475-PZ3-1				
475-3-1, 475-4-1, 475-5-5-1				
475-H3-1, 475-H4-1, 475-H5-1, 475-H6-1				

**JUEGO BOCALLAVES MIXTO 1/4"-1/2", HEXAGONALES,  
53 piezas**



- Juego de bocallaves, 53 piezas
- Bocallaves hexagonales, mm
- Acabado cromado brillante
- DIN 3120, DIN 3124, DIN 3122
- Caja fabricada en polietileno de alta densidad y resistente
- Caja con cierres metálicos

1	2	3	4	5
129A-53-4	1	53	380x280x80	4.750
105-48-1		105-70-1		
105-42-1		105-50-1		
105-22-1		105-24-1		
105-40-1		125-70-1		
125-25-1		125-43-1		
125-23-1		125-40-1		
101A-05-1, 101A-06-1, 101A-07-1, 101A-08-1, 101A-09-1, 101A-10-1, 101A-11-1, 101A-12-1, 101A-14-1, 101A-16-1, 101A-18-1				
122A-10-1, 122A-11-1, 122A-12-1, 122A-14-1, 122A-16-1, 122A-18-1, 122A-20-1, 122A-22-1, 122A-24-1, 122A-26-1, 122A-28-1, 122A-30-1, 122A-34-1, 122A-38-1, 122A-40-1				
040001, 040011, 040021				
475-PH1-1, 475-PH2-1, 475-PH3-1				
475-PZ1-1, 475-PZ2-1, 475-PZ3-1				
475-3-1, 475-4-1, 475-5-5-1				
1/4" Hex 1/8", 5/32", 3/16", 7/32" AF				





## JUEGO BOCALLAVES 1/2"

### JUEGO BOCALLAVES MIXTO 1/4"-1/2", 108 piezas



- Juego de bocallaves de 108 piezas
- Bocallaves hexagonales, mm
- Acabado cromado brillante
- DIN 3120, DIN 3124, DIN 3122
- Caja fabricada en polietileno de alta densidad y resistente
- Caja con cierres metálicos

Part Number	Quantity	Material	Dimensions	Weight
129-108-4	1	108	380x280x80	7.100
105-48-1		105-70-1		
125-42-1		105-50-1		
105-22-1		105-40-1		
105-24-1		125-70-1		
125-48-1		125-43-1		
125-25-1		125-23-1		
125-40-1				
101-04-1, 101-045-1, 101-05-1, 101-055-1, 101-06-1, 101-07-1, 101-08-1, 101-09-1, 101-10-1, 101-11-1, 101-12-1, 101-13-1, 101-14-1			1/4"	
103-06-1, 103-07-1, 103-08-1, 103-09-1, 103-10-1, 103-12-1, 103-13-1			1/4"	
106-04-1, 106-05-1, 106-06-1, 106-07-1, 106-08-1				
121-10-1, 121-11-1, 121-12-1, 121-13-1, 121-14-1, 121-15-1, 121-16-1, 121-17-1, 121-18-1, 121-19-1, 121-20-1, 121-21-1, 121-22-1, 121-24-1, 121-27-1, 121-30-1, 121-32-1			1/2"	
126-10-1, 126-11-1, 126-12-1, 126-14-1, 126-16-1, 126-18-1, 126-20-1, 126-24-1				
124-14-1, 124-15-1, 124-17-1, 124-19-1, 124-22-1			1/2"	
125-53-1, 125-54-1				
107-T08-1, 107-T10-1, 107-T15-1, 107-T20-1, 107-T25-1, 107-T27-1, 107-T30-1				
107-H3-1, 107-H4-1, 107-H5-1, 107-H6-1				
107-PH1-1, 107-PH2-1				
107-PZ1-1, 107-PZ2-1				
107-0840-1, 107-1055-1, 107-1280-1				
040001, 040011, 040021				
045801, 045811, 045821				
470-10.0-1, 470-12.0-1, 470-8.0-1				
470-H10-1, 470-H7-1, 470-H8-1				
470-PH3-1, 470-PH4-1				
470-T40-1, 470-T45-1, 470-T50-1, 470-T55-1, 470-T60-1				
470-PZ3-1, 470-PZ4-1				

### JUEGO BOCALLAVES MIXTO 1/4"-1/2", HEXAGONALES, 103 piezas



- Juego de bocallaves, 103 piezas
- Bocallaves hexagonales, pulgadas
- Acabado cromado brillante
- DIN 3120, DIN 3124, DIN 3122
- Caja fabricada en polietileno de alta densidad y resistente
- Caja con cierres metálicos

Part Number	Quantity	Material	Dimensions	Weight
129A-103-4	1	103	380x280x80	7.000
105-40-1		105-70-1		
105-42-1		105-50-1		
105-22-1		105-24-1		
125-70-1		125-43-1		
125-25-1		125-40-1		
125-23-1		125-48-1		
101A-05-1, 101A-06-1, 101A-07-1, 101A-08-1, 101A-10-1, 101A-11-1, 101A-12-1, 101A-14-1, 101A-16-1, 101A-18-1			1/4"	
103A-06-1, 103A-08-1, 103A-09-1, 103A-10-1, 103A-11-1, 103A-12-1, 103A-14-1, 103A-16-1			1/4"	
106-04-1, 106-05-1, 106-06-1, 106-07-1, 106-08-1				
122A-12-1, 122A-14-1, 122A-16-1, 122A-18-1, 122A-20-1, 122A-22-1, 122A-24-1, 122A-26-1, 122A-28-1, 122A-40-1			1/2"	
124A-18-1, 124A-20-1, 124A-22-1, 124A-24-1, 124A-26-1			1/2"	
126-10-1, 126-11-1, 126-12-1, 126-14-1, 126-16-1, 126-18-1, 126-20-1, 126-24-1				
125-53-1, 125-54-1				
107-T08-1, 107-T09-1, 107-T10-1, 107-T15-1, 107-T20-1, 107-T25-1, 107-T27-1, 107-T30-1				
107A-4-1, 107A-5-1, 107A-6-1, 107A-7-1				
107-PH1-1, 107-PH2-1				
107-PZ1-1, 107-PZ2-1				
107-0840-1, 107-1055-1, 107-1280-1				
040001, 040011, 040021				
470-T40-1, 470-T45-1, 470-T50-1, 470-T55-1, 470-T60-1				
470-10.0-1, 470-12.0-1, 470-8.0-1				
470-H7-1, 470-H8-1, 470-H10-1, 470-H12-1, 470-H14-1				
470-PH3-1, 470-PH4-1				
470-PZ3-1, 470-PZ4-1				

**JUEGO BOCALLAVES MIXTO 1/4"-1/2",  
101 piezas**



- Juego de bocallaves 101 piezas
- Bocallaves Hex mm
- Acabado cromado brillante
- DIN 3120, DIN 3124 y DIN 3122
- Caja fabricada en polietileno de alta densidad y resistente
- Caja con cierres metálicos

129-101-4	1	101	380x280x80	7.000
105-48-1		105-70-1		
125-42-1		105-50-1		
105-22-1		105-40-1		
105-24-1		105-28-1		
125-70-1		125-43-1		
125-25-1		125-40-1		
125-23-1		125-48-1		
101-04-1, 101-045-1, 101-05-1, 101-055-1, 101-06-1, 101-07-1, 101-08-1, 101-09-1, 101-10-1, 101-11-1, 101-12-1, 101-13-1, 101-14-1				1/4"
103-06-1, 103-07-1, 103-08-1, 103-10-1, 103-11-1, 103-12-1, 103-13-1, 103-14-1				1/4"
121-08-1, 121-10-1, 121-12-1, 121-13-1, 121-14-1, 121-16-1, 121-17-1, 121-19-1, 121-20-1, 121-21-1, 121-22-1, 121-23-1, 121-24-1, 121-26-1, 121-27-1, 121-28-1, 121-30-1, 121-32-1				1/2"
124-13-1, 124-17-1, 124-19-1, 124-22-1				1/2"
107-T08-1, 107-T10-1, 107-T15-1, 107-T20-1, 107-T25-1, 107-T30-1				
107-H3-1, 107-H 4-1, 107-H5-1, 107-H6-1				
107-PH1-1, 107-PH2-1				
107-PZ1-1, 107-PZ2-1				
107-0840-1, 107-1055-1, 107-1280-1				
040001, 040011, 040021				
475-H3-1, 475-H4-1, 475-H5-1				
475-T10-1, 475-T15-1, 475-T20-1, 475-T25-1, 475-T27-1, 475-T30-1				
470-8.0-1, 470-10.0-1				
470-H6-1, 470-H7-1, 470-H8-1, 470-H10-1				
470-T30-1, 470-T40-1, 470-T45-1, 470-T50-1, 470-T55-1				

**JUEGO BOCALLAVES 1/4"- 3/8"-1/2" HEXAGONALES, MM**



- Juego de bocallaves de 164 piezas
- Bocallaves hexagonales, mm
- Acabado cromado brillante
- DIN 3120, DIN 3124, DIN 3122
- Caja fabricada en polietileno de alta densidad y resistente
- Caja con dos cierres extra para mayor seguridad en el transporte

149-164-4	1	164	490x370x100	12.919
105-48-1		105-70-1		
105-24-1		105-50-1		
105-22-1		105-40-1		
115-70-1		115-40-1		
115-20-1		115-24-1		
115-44-1		115-46-1		
115-48-1		125-70-1		
125-23-1		125-25-1		
125-46-1		125-40-1		
601-200-1		612-160-1		
475R-1/4-30		48-9-H		
475-5-1				
101-04-1, 101-05-1, 101-055-1, 101-06-1, 101-07-1, 101-08-1, 101-09-1, 101-10-1, 101-11-1, 101-12-1				1/4"
103-04-1, 103-05-1, 103-06-1, 103-07-1, 103-08-1, 103-09-1, 103-10-1, 103-11-1, 103-12-1				1/4"
112-08-1, 112-09-1, 112-10-1, 112-11-1, 112-12-1, 112-13-1, 112-14-1, 112-15-1, 112-16-1, 112-17-1, 112-18-1, 112-19-1				3/8"
113-08-1, 113-09-1, 113-10-1, 113-11-1, 113-12-1, 113-13-1, 113-14-1, 113-15-1, 113-17-1, 113-19-1				3/8"
121-14-1, 121-17-1, 121-18-1, 121-19-1, 121-20-1, 121-21-1, 121-22-1, 121-24-1, 121-27-1, 121-30-1, 121-32-1				1/2"
124-12-1, 124-13-1, 124-14-1, 124-15-1, 124-17-1, 124-18-1, 124-19-1, 124-21-1, 124-22-1				1/2"
167-17-1, 167-19-1, 167-21-1, 167-23-1				1/2"
18-12-1, 18-13-1, 18-14-1				
25-08-1, 25-09-1, 25-10-1, 25-11-1, 25-12-1, 25-13-1, 25-14-1, 25-17-1, 25-18-1, 25-19-1				
475-T10-1, 475-T15-1, 475-T20-1, 475-T25-1, 475-T27-1, 475-T30-1, 475-T40-1				
475-TR10-1, 475-TR15-1, 475-TR20-1, 475-TR25-1, 475-TR27-1, 475-TR30-1, 475-TR40-1				
Bocallaves con punta para bujías 3/8": 16-21 mm				
Bocallaves con punta 3/8": 3-4-5-6 mm				
Bocallaves con punta 3/8": PH1-PH2				
Bocallaves con punta 3/8": PZ1-PZ2				
Bocallaves con punta 3/8": TR10-TR15-TR20-TR25-TR30-TR40				
Bocallaves con punta 3/8" TORX®: E8, E10, E11, E12, E14, E16, E18, E20				



## BOCALLAVES 3/4"

### BOCALLAVES 3/4" HEXAGONAL

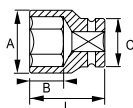

### BOCALLAVES 3/4" ESTRIADO

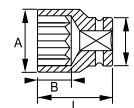

- Bocallaves en milímetros, diseño hexagonal
- Acero aleado Cromo Vanadio
- Acabado cromado brillante
- Perfil NPP
- DIN 3124, DIN 3120

E			A mm	B mm	C mm	L mm	g
131-19-1	1	19	30	12	36	50	200
131-21-1	1	21	32	12	36	50	215
131-22-1	1	22	33	12	36	50	215
131-23-1	1	23	34	14	36	50	215
131-24-1	1	24	34	16	36	50	215
131-25-1	1	25	38	16	36	50	220
131-26-1	1	26	38	16	36	52	220
131-27-1	1	27	38	18	36	52	240
131-28-1	1	28	38	18	36	52	250
131-29-1	1	29	42	18	38	52	260
131-30-1	1	30	42	20	38	52	275
131-32-1	1	32	44	22	38	52	310
131-33-1	1	33	46	22	38	55	340
131-34-1	1	34	46	22	38	57	330
131-35-1	1	35	48	24	42	57	380
131-36-1	1	36	50	24	42	57	415
131-38-1	1	38	52	26	44	57	455
131-40-1	1	40	56	27	44	63	505
131-41-1	1	41	56	27	44	63	545
131-42-1	1	42	58	27	44	63	600
131-46-1	1	46	62	30	44	68	650
131-50-1	1	50	68	33	44	72	755
131-55-1	1	55	75	36	48	75	1.000
131-60-1	1	60	80	39	48	77	1.100

- Bocallaves en milímetros, diseño estriado
- Acero aleado Cromo Vanadio
- Acabado cromado brillante
- Perfil NPP
- DIN 3120, DIN 3124

E			A mm	B mm	C mm	L mm	g
132A-28-1	1	7/8"	33	12	36	50	215
132A-30-1	1	15/16"	35	16	36	50	215
132A-32-1	1	1"	38	16	36	52	200
132A-34-1	1	1.1/16	38	18	36	54	240
132A-36-1	1	1.1/8"	42	18	38	55	280
132A-40-1	1	1.1/4"	44	22	38	55	310
132A-42-1	1	1.5/16"	46	22	38	57	340
132A-44-1	1	1.3/8"	48	24	42	57	380
132A-46-1	1	1.7/16"	50	24	42	57	415
132A-48-1	1	1.1/2"	52	26	44	57	455
132A-52-1	1	1.5/8"	56	27	44	63	545
132A-54-1	1	1.11/16"	58	27	44	63	600
132A-60-1	1	1.7/8"	65	30	44	68	700
132A-64-1	1	2"	68	33	44	72	755

## ACCESORIOS 3/4"

### CABEZA DE CRIQUE

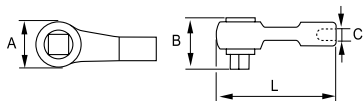

- 24 dientes
- Acabado cromado brillante
- Botón de rápida liberación
- Mango bicomponente
- DIN 3120, DIN 3122

Q	Icono	A mm	B mm	C mm	L mm	g
135-70-1	1	65	61.5	20	155	1.360

### MANERAL

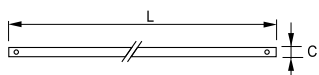

- Mango de crিকে

Q	Icono	C mm	L mm	g
135-85-1	1	20	450	1.100

### CABEZA MANGO CORREDIZO

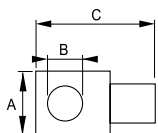

- Sistema de retención por bola

Q	Icono	A mm	B mm	C mm	g
135-43-1	1	35	20.5	60	235

### REDUCTOR

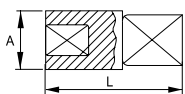

- Adaptador reductor 3/4" a 1/2"
- Sistema de retención por bola

Q	Icono	A mm	L mm	g
135-46-1	1	36	54	260

### ALARGADERAS

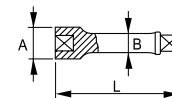

- Sistema de retención por bola

Q	Icono	A mm	B mm	L mm	g
135-21-1	1	36	23	125	515
135-22-1	1	36	23	200	725
135-24-1	1	36	23	400	1.350

### MANGO CORREDIZO EN T

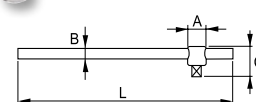

- Sistema de retención por bola

Q	Icono	A mm	B mm	C mm	L mm	g
135-42-1	1	36	20	60	450	1.335

### ARTICULACIÓN UNIVERSAL

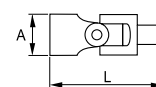

- Sistema de retención por bola

Q	Icono	A mm	L mm	g
135-40-1	1	40	108	540

### MANGO ARTICULADO

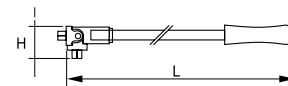

- Sistema de retención por bola

Q	Icono	H mm	L mm	g
135-52-1	1	40	450	1.700

## JUEGO BOCALLAVES 3/4"

### JUEGO BOCALLAVES 3/4", HEXAGONALES, MM, 17 piezas



- Juego de bocallaves 17 piezas
- Bocallaves hexagonales, mm
- Acero aleado Cromo Vanadio
- Acabado cromado brillante
- DIN 3120, DIN 3124, DIN 3122
- Caja fabricada en polietileno de alta densidad y resistente
- Caja con cierres metálicos
- Referencia caja de repuesto: SP-106S-BOX17
- Referencia dos cierres de recambio: SP104S

139-17-4	1	17	475x295x100	12.500
135-70-1		135-24-1		
135-22-1		135-43-1		
135-85-1				
131-22-1, 131-24-1, 131-27-1, 131-30-1, 131-32-1, 131-33-1, 131-34-1, 131-36-1, 131-38-1, 131-41-1, 131-46-1, 131-50-1				

### JUEGO BOCALLAVES 3/4", HEXAGONALES, MM, 21 piezas



- Juego de bocallaves de 21 piezas
- Bocallaves hexagonales, mm
- Acero aleado Cromo Vanadio
- Acabado cromado brillante
- DIN 3120, DIN 3124, DIN 3122
- Caja fabricada en polietileno de alta densidad y resistente
- Caja con cierres metálicos
- Referencia caja de recambio: SP-106S-BOX21

139-21-4	1	21	475x295x100	11.900
135-70-1		135-24-1		
135-22-1		135-43-1		
135-85-1				
131-19-1, 131-21-1, 131-22-1, 131-23-1, 131-24-1, 131-26-1, 131-27-1, 131-29-1, 131-30-1, 131-32-1, 131-35-1, 131-36-1, 131-38-1, 131-41-1, 131-46-1, 131-50-1				

### JUEGO BOCALLAVES 3/4", ESTRIADOS, MM, 21 piezas



- Juego de bocallaves de 21 piezas
- Bocallaves hexagonales, mm
- Acero aleado Cromo Vanadio
- Acabado cromado brillante
- DIN 3120, DIN 3124, DIN 3122
- Caja fabricada en polietileno de alta densidad y resistente
- Caja con cierres metálicos
- Referencia caja de recambio: SP-106S-BOX21

139-21B-4	1	21	475x295x100	11.900
135-70-1		135-24-1		
135-22-1		135-43-1		
135-85-1				
131B-19-2, 131B-21-2, 131B-22-2, 131B-23-2, 131B-24-2, 131B-26-2, 131B-27-2, 131B-29-2, 131B-30-2, 131B-32-2, 131B-35-2, 131B-36-2, 131B-38-2, 131B-41-2, 131B-46-2, 131B-50-2				

## BOCALLAVES IMPACTO 1/2"

### BOCALLAVES DE IMPACTO 1/2" HEXAGONAL

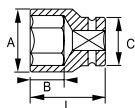

- Bocallaves en milímetros, diseño hexagonal
- UNE 16507, ISO 2725, DIN 3129

Artículo	Paquete	Altura (A mm)	Ancho (B mm)	Profundidad (C mm)	Largo (L mm)	Peso (g)	
167-08-1	1	8	15	15	25	38	84
167-10-1	1	10	17.5	15	25	38	89
167-12-1	1	12	19	15	25	38	94
167-13-1	1	13	20	15	25	38	94
167-14-1	1	14	22	15	25	38	94
167-15-1	1	15	23	15	25	38	134
167-16-1	1	16	24	15	25	38	134
167-17-1	1	17	26	15	30	38	134
167-18-1	1	18	27	15	30	38	134
167-19-1	1	19	28	17.5	30	38	134
167-20-1	1	20	29	17.5	30	38	137
167-21-1	1	21	30	17.5	30	38	149
167-22-1	1	22	32	17.5	30	38	149
167-23-1	1	23	34	18	30	40	149
167-24-1	1	24	34	18	30	40	179
167-26-1	1	26	36	22	30	42	189
167-27-1	1	27	38	22	30	42	204
167-30-1	1	30	42	22	30	44	234
167-32-1	1	32	44	22	40	44	282
167-34-1	1	34	46	22	40	48	406
167-36-1	1	36	48	22	40	48	467

### JUEGO BOCALLAVES DE IMPACTO EN RAIL



Artículo	Paquete	Cantidad	Tallas	Peso (g)
167-91-2	1	5	17 - 19 - 22 - 24 - 27 mm	835
167-90-2	1	9	8 - 10 - 12 - 14 - 17 - 19 - 22 - 24 - 27 mm	1.180

### JUEGO BOCALLAVES DE IMPACTO 1/2", 10 piezas



- Juego con 10 bocallaves de impacto
- Bocallaves hexagonales
- Acabado fosfatado
- ISO 2725, DIN 3129
- Caja fabricada en polietileno de alta densidad y resistente

Artículo	Paquete	Cantidad	Dimensiones (mm)	Peso (g)
167-10-4	1	10	200x160x52	1.425

167-10-1, 167-13-1, 167-14-1, 167-16-1, 167-17-1, 167-18-1, 167-19-1, 167-21-1, 167-22-1, 167-24-1



## BOCALLAVES IMPACTO 1/2"

### BOCALLAVES DE IMPACTO 1/2" HEX, SERIE LARGA



168-19-1	1	19	A mm	B mm	C mm	L mm	g
168-19-1	1	19	28	39	30	78	246

### JUEGO BOCALLAVES DE IMPACTO LARGOS EN RAIL



168-90-2	1	7	10 - 13 - 17 - 19 - 22 - 24 - 27 mm	1.735
168-90-2	1	7	10 - 13 - 17 - 19 - 22 - 24 - 27 mm	1.735

## ACCESORIOS BOCALLAVES IMPACTO 1/2"

### ALARGADERA

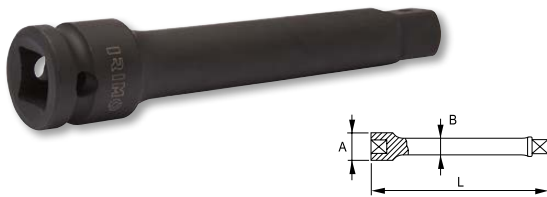

- DIN 16503, ISO 1174

169-03-1	1	A mm	B mm	L mm	g
169-03-1	1	25	16.5	75	139
169-01-1	1	25	16.5	125	274
169-02-1	1	25	16.5	150	484

### ANILLAS DE SEGURIDAD



- Anillas de seguridad 1/2"

169921	1	1/2"	10-14	5-10	2
169921	1	1/2"	10-14	5-10	2
169931	1	1/2"	15-36	12-19	2

### AUMENTADOR

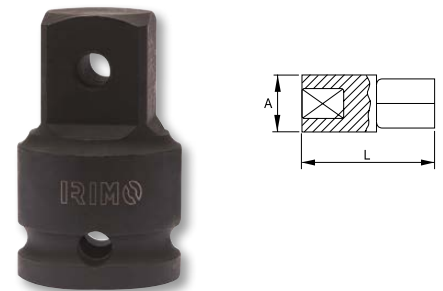

- Aumentador de 1/2" a 3/4"
- DIN 16503, ISO 1174

169-60-1	1	A mm	L mm	g
169-60-1	1	30	48	114

### JUNTA CARDAN



- DIN 16503, ISO 1174

169-25-1	1	A mm	L mm	g
169-25-1	1	30	63	189

### BOCALLAVES IMPACTO 3/4"

#### BOCALLAVES DE IMPACTO 3/4" HEXAGONAL

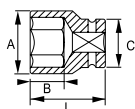

- Bocallaves en milímetros, diseño hexagonal
- UNE 16507, ISO 2725, DIN 3129

Q	Icon	A mm	B mm	C mm	L mm	g	
173-17-2	1	17	30	21	44	51	339
173-18-2	1	18	32	21	44	51	339
173-19-2	1	19	33	21	44	51	349
173-21-2	1	21	35	21	44	51	359
173-22-2	1	22	36	21	44	51	359
173-23-2	1	23	37	21	44	51	369
173-24-2	1	24	38	21	44	51	379
173-27-2	1	27	41	21	44	51	399
173-28-2	1	28	42	23	44	51	409
173-29-2	1	29	45	23	44	51	409
173-30-2	1	30	46	23	44	51	439
173-32-2	1	32	48	27	44	57	469
173-33-2	1	33	50	27	44	57	489
173-34-2	1	34	51	27	44	57	509
173-36-2	1	36	53	27	44	57	519
173-38-2	1	38	56	27	44	57	559
173-41-2	1	41	59	28	44	58	659
173-46-2	1	46	66	30	44	62	709
173-50-2	1	50	71	32	54	65	839
173-55-2	1	55	77	37	54	70	1109
173-60-2	1	60	84	37	54	70	1200

#### JUEGO DE BOCALLAVES IMPACTO 3/4", 8 piezas



- Juego en caja metálica

Q	Icon	Icon	Icon	g
173-01-5	1	8	24 - 27 - 29 - 30 - 32 - 34 - 36 - 38 mm	4.000

#### BOCALLAVES DE IMPACTO 3/4" HEX, SERIE LARGA

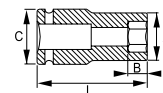

Q	Icon	A mm	B mm	C mm	L mm	g	
174-17-2	1	17	30	23	44	90	560
174-19-2	1	19	33	23	44	90	600

### ACCESORIOS 3/4"

#### JUNTA CARDAN

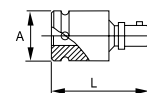

- DIN 16503, ISO 1174

Q	Icon	A mm	L mm	g
175-25-2	1	42	92	580

#### ANILLAS DE SEGURIDAD

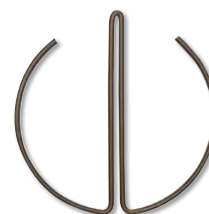

- Anillas de seguridad 3/4"

Q	Icon	Icon	Icon	Icon	g
175911	1	3/4"	17-46	12-24	2
179931	1	3/4"	50-60		2



ACCESORIOS 3/4"

ALARGADERAS

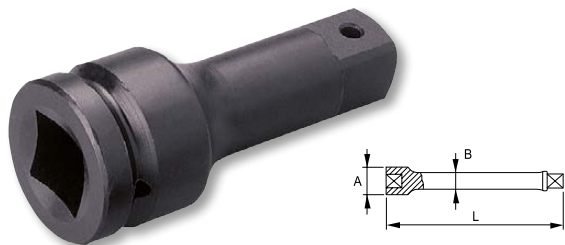

- DIN 16503, ISO 1174

Q	Icon	A mm	B mm	L mm	g
175-01-2	1	175	44	21	850
175-10-2	1	250	44	21	1.190
175-02-2	1	325	44	21	1.460

REDUCTOR



- Reductor de 3/4" a 1/2"
- DIN 16503, ISO 1174
- Dadas las condiciones especiales de este producto no está garantizado contra la rotura del cuadrado macho

Q	Icon	A mm	L mm	g
175-65-2	1	44	57	350



## TORNILLOS DE BANCO

### GUÍA CUADRADA

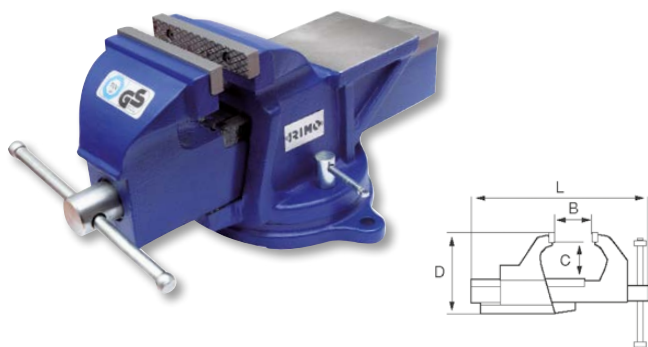

- Tornillo banco guía cuadrada
- Fundición dúctil para mayor resistencia a impactos, con características similares al acero
- Fijado con la base giratoria
- Yunque cuadrado largo
- Pin sujeción al husillo para evitar la caída de la mordaza
- Mordazas y husillos disponibles
- Certificación GS

R	Icono	mm	B mm	C mm	D mm	L mm	g
207-100	1	100	100	61	164	330	11.450
207-125	1	125	125	72	193	408	20.000
207-150	1	150	150	84	223	466	29.700

### TORNILLO DE BANCO DE SOBREMESA

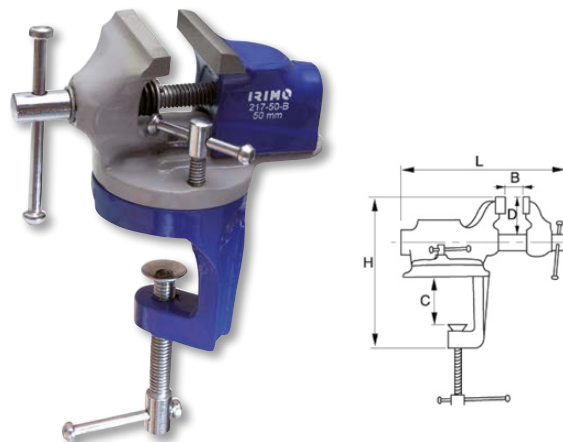

- Herramienta versátil
- Base giratoria
- Yunque acabado
- Material: hierro fundido
- En blíster

R	Icono	mm	B mm	C mm	D mm	H mm	L mm	g
217-50-B	1	50	40	34	20	120	125	1.100

### HUSILLO Y TUERCA



- Husillo y tuerca para tornillo guía cuadrada 207-100 / 207-150

R	Icono	mm	L mm	g
206-100	1	100	165	560
206-125	1	125	188	920
206-150	1	150	216	1.060

### MORDAZAS DE AJUSTE RÁPIDO



- Mordazas de alta resistencia con sistema de ajuste rápido
- Capacidad de sujeción: más de 60 kg
- Mordaza reversible

R	Icono	A mm	B mm	L mm	g
254-150-2	1	150 - 6"	60	335	487
254-300-2	6	300 - 12"	60	485	586
254-450-2	6	450 - 18"	60	635	686
254-600-2	6	600 - 24"	60	785	781
254-900-2	6	900 - 36"	60	1.085	980
254-1200-2	4	1.200 - 48"	60	1.685	1.165

LLAVES PARA CAÑO

LLAVE STILLSON

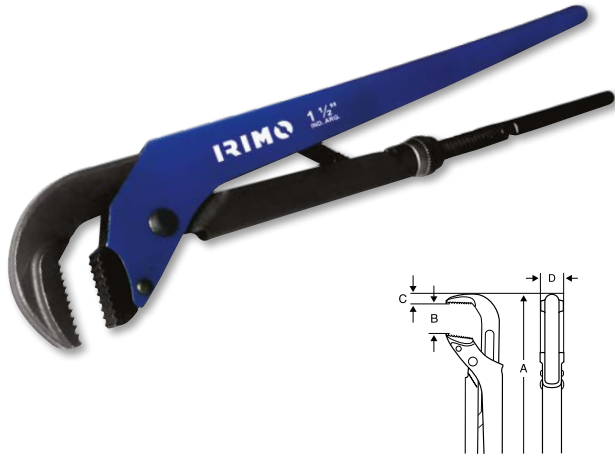

- La combinación ideal entre el bajo peso y resistencia gracias al cuerpo conformado en chapa de acero de alta tenacidad
- Mangos redondeados de espesor y longitud ideales para un agarre cómodo y firme de la llave
- Gran capacidad de agarre en tubos de hasta 38 mm (1.1/2")
- Apertura de boca hasta 66 mm
- Robustez dada por el diseño de sus quijadas
- Dentado angulado para asegurar un agarre sin deslizamientos
- Dientes templados a inducción para una mayor durabilidad
- Topes de seguridad en varilla roscada
- Tratamiento anticorrosivo de fosfatizado
- Fabricación nacional
- Norma DIN 5234

R			B mm	C mm	S inch	D mm	A mm	g
303-14	1	1 1/2"	66	18	1 1/2"	38	344	1.050

LLAVE STILLSON DE ALUMINIO

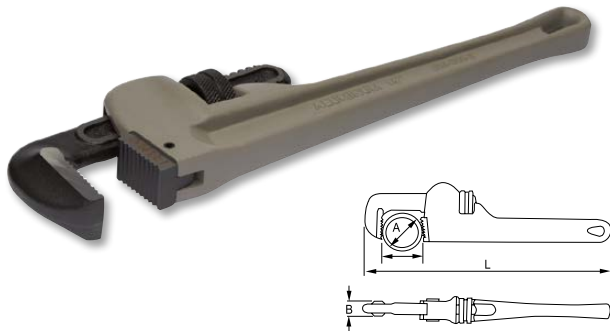

- Cuerpo de aleación de aluminio de alta resistencia con sección en doble T
- Ligera 40% menos de peso y alta resistencia

R		A inch	A mm	B mm	L inch	L mm	g
304-250-2	2	1.1/2"	22	17	10"	250	430
304-350-2	2	2"	26	21	14"	350	950
304-450-2	1	2.1/2"	29	26	18"	450	1.650
304-600-2	1	3"	33	28	24"	600	2.500
304-900-2	1	5"	44	32	36"	900	5.200

REPUESTOS PARA LLAVE STILLSON DE ALUMINIO



R	R	R		L inch
304S-250-2	304T-250-2	304F-250-2	1	10"
304S-350-2	304T-350-2	304F-350-2	1	14"
304S-450-2	304T-450-2	304F-450-2	1	18"
304S-600-2	304T-600-2	304F-600-2	1	24"
304S-900-2	304T-900-2	304F-900-2	1	36"

## CORTATUBOS

### MINI CORTATUBOS PARA TUBOS DE COBRE



- Esmaltado
- Fosfatado

E		S	Ø	L	g
			mm	mm	
321161	2	1/8" - 5/8"	3 - 16	58	122

### CORTATUBOS UNIVERSAL



- Esmaltado
- Fosfatado

E		S	Ø	L	g
			mm	mm	
321281	1	1/8" - 1.1/8"	3 - 30	30	321

### CORTATUBOS PARA TUBOS DE ACERO

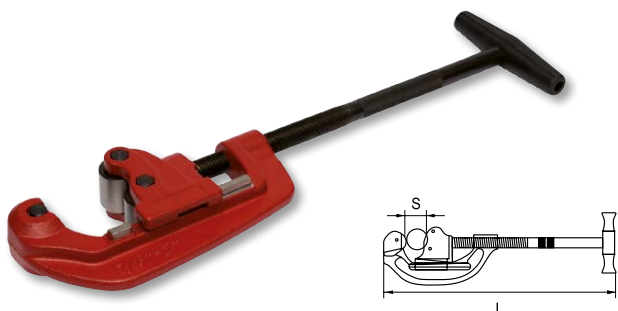

- Esmaltado
- Fosfatado

E		S	Ø	L	g
			mm	mm	
321501	1	1/8" - 2"	3 - 50	385	2.520

### CUCHILLAS DE REPUESTO



E			D	d	E	g
			mm	mm	mm	
321511	1	321161 / 321171 / 321281 / 321321 / 321351	20	5	5	5
321551	1	321501	31	9	19	28

## SACABOCADOS

### REVÓLVER SACABOCADOS

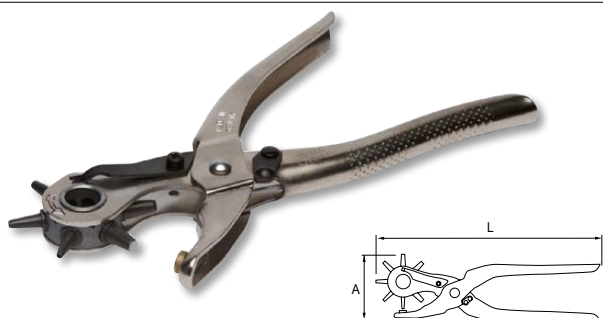

- Seis tamaños de perforación para materiales tan variados como cuero, caucho, lona, juntas y otros similares
- Fácil selección y visión del diámetro para evitar errores
- Su diseño único reduce la fuerza necesaria para el perforado en un 70%

E		S	Ø	L	g
			mm	mm	
330021	1	1/8" - 2"	3 - 50	385	2.520



## DESTORNILLADORES

### DESTORNILLADORES PUNTA RECTA



- Para tornillos ranurados rectos de cabeza plana y con punta de electricista
- Para un uso intensivo
- Mango bi-componente para un agarre cómodo y mayor transferencia de fuerza
- La forma del mango impide que la herramienta resbale
- Varilla de aleación de acero de alto rendimiento, cromado y templado
- ISO 2380/DIN 5264 y UNE 16516

R	Icono	Ø mm	Ø <sub>ext</sub> mm	Ø <sub>int</sub> mm	L mm	L <sub>ext</sub> mm	L <sub>int</sub> mm	g
408A-4-125	6	4	0,8	4	125	22,7 x 82	207	48
408A-4-200	6	4	0,8	4	200	22,7 x 82	282	68

### DESTORNILLADORES PUNTA CÓNICA



- Para tornillos ranurados
- Para un uso intensivo
- Mango bi-componente para un agarre cómodo y mayor transferencia de fuerza
- La forma del mango impide que la herramienta resbale
- Varilla de aleación de acero de alto rendimiento, cromado y templado
- ISO 2380/DIN 5264 y UNE 16516

R	Icono	Ø mm	Ø <sub>ext</sub> mm	Ø <sub>int</sub> mm	L mm	L <sub>ext</sub> mm	L <sub>int</sub> mm	g
407A-4-75	6	4	0,8	4	75	22,7 x 82	157	49
407A-4-100	6	4	0,8	4	100	22,7 x 82	182	54
407A-4-125	6	4	0,8	4	125	22,7 x 82	207	59
407A-5-5-100	6	5,5	1,0	5,5	100	27,7 x 99	199	71
407A-5-5-125	6	5,5	1,0	5,5	125	27,7 x 99	224	76
407A-5-5-150	6	5,5	1,0	5,5	150	27,7 x 99	249	81
407A-6-5-100	6	6,5	1,2	6,5	100	31,1 x 109	209	89
407A-6-5-125	6	6,5	1,2	6,5	125	31,1 x 109	234	94
407A-6-5-150	6	6,5	1,2	6,5	150	31,1 x 109	259	99
407A-8-150	6	8	1,6	8	150	31,1 x 109	259	114

### DESTORNILLADORES PUNTA PHILLIPS



- Para tornillos Phillips
- Para un uso intensivo
- Mango bi-componente para un agarre cómodo y mayor transferencia de fuerza
- La forma del mango impide que la herramienta resbale
- Varilla de aleación de acero de alto rendimiento, cromado y templado
- ISO 2380/DIN 5264 y UNE 16516

R	Icono	Ø mm	L mm	L <sub>ext</sub> mm	L <sub>int</sub> mm	g	
409A-0-75	6	PH-0	3	75	22,7 x 82	157	27
409A-0-200	6	PH0	3	200	22,7 x 82	282	51
409A-1-100	6	PH1	5	100	27,7 x 99	199	67
409A-1-125	6	PH1	5	125	27,7 x 99	224	67
409A-1-150	6	PH1	5	150	27,7 x 99	249	69
409A-2-100	6	PH2	6	100	32 x 109	209	99
409A-2-125	6	PH2	6	125	32 x 109	234	109
409A-2-150	6	PH2	6	150	32 x 109	259	115
409A-2-200	6	PH2	6	200	32 x 109	309	130
409A-3-150	6	PH3	8	150	32 x 109	259	157

### DESTORNILLADOR PERILLERO PUNTA RECTA



- Para tornillos ranurados
- La forma del mango impide que la herramienta resbale
- Varilla de aleación de acero de alto rendimiento, cromado y templado
- ISO 2380/DIN 5264 y UNE 16516

R	Icono	Ø mm	Ø <sub>ext</sub> mm	Ø <sub>int</sub> mm	L mm	L <sub>ext</sub> mm	L <sub>int</sub> mm	g
415A-PP3-60	6	3	3	0,5	60	12 x 60	120	10

### DESTORNILLADOR PERILLERO PUNTA PHILLIPS



- Para tornillos Phillips
- La forma del mango impide que la herramienta resbale
- Varilla de aleación de acero de alto rendimiento, cromado y templado
- ISO 2380/DIN 5264 y UNE 16516

R	Icono	Ø mm	L mm	L <sub>ext</sub> mm	L <sub>int</sub> mm	g	
415A-PH0-60	6	PH-0	3	60	12 x 60	120	10

## JUEGOS DE DESTORNILLADORES

### SET DESTORNILLADORES EN BLISTER



- Set de 6 destornilladores punta Plana y Phillips:  
4 punta Plana: 75x4; 100x4; 100x5,5; 100x6,5 mm  
2 punta Phillips: PH1x100; PH2x100 mm
- Embalaje en blíster

459A-6-B	6	6	40 x 320 x 200	282

407A-4-75; 407A-4-100; 407A-5.5-125; 407A-6.5-100		409A-1-100; 409A-2-100	
--	--	---------------------------	--

### SET DESTORNILLADORES EN BLISTER



- Set de 9 destornilladores punta Plana y Phillips:  
6 punta Plana: 60x3; 75x4; 100x4; 125x4; 125x5,5; 125x6,5 mm  
3 punta Phillips: PH0x60; PH1x125; PH2x125 mm
- Embalaje en blíster

459A-9-B	6	9	40 x 320 x 200	423

407A-4-100; 407A-5.5-125; 407A-6.5-125		409A-1-125; 409A-2-125	
415A-PP3-60		415A-PH0-60	

### PORTAPUNTAS MAGNÉTICO PARA PUNTAS 1/4"



- Mango: bi-material con agujero para colgar
- Varilla: templada y cromada fabricada en acero de alto rendimiento
- Imán fuerte
- Marcado: código y tamaño marcado por láser en varilla

475-1/4-125	5	1/4"	125	235	112

### PORTAPUNTAS MAGNÉTICO FLEXIBLE PARA PUNTAS 1/4"



- Mango: bi-material con agujero para colgar
- Varilla: templada y cromada fabricada en acero de alto rendimiento
- Con muelle retención

475-1/4F-160	5	1/4"	160	270	135

JUEGOS DE DESTORNILLADORES

JUEGO TORX®, 6 piezas



- Para tornillos TORX®
- En caja de cartón

459-6B-C	1	6	42x325x160	470
414-10-75, 414-15-100, 414-20-100, 414-25-125, 414-27-125, 414-30-150				

DESTORNILLADORES DE CARRACA PARA 12 PUNTAS DE 1/4"

DESTORNILLADOR DE CRIQUE CON COMPARTIMENTO PARA 12 PUNTAS DE 1/4"



- Mango: bi-material
- Compartimiento de almacenamiento para intercambiar puntas con botón de liberación rápida
- Compartimiento deslizable con 12 puntas diferentes: Ranurado 4, 5, 6 mm; PH 1, 2, 3; TORX® 15, 20, 25; Hex 3, 4, 5 mm
- El imán asegura las puntas al de destornillador
- Golpe de carraca suave
- Mecanismo de carraca de tres posiciones: avance, retroceso y neutral

475R-1/4-110	6	1/4"	110	125	235	310

DESTORNILLADOR A CRIQUE MANGO CARROCERO



- Destornillador porta puntas a carraca con mango de carrocerero
- Mango: bi-componente
- Compartimiento para puntas intercambiables
- 6 puntas dobles de 1/4": Planas 5.0, 6.0 mm; PH1, PH2; T15, T20, T25, T30; Hex 2.5, 3, 4, 5 mm
- La varilla magnética asegura las puntas en el destornillador
- Carraca de trinquete suave. Mecanismo de 3 posiciones
- En blíster

475R-1/4-30	6	1/4"	30	80	110	192

### DESTORNILLADORES DE SEGURIDAD

#### JUEGO 2 DESTORNILLADORES AISLADOS + TESTER

IEC 60900 1000V

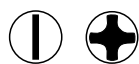

- Juego de destornilladores, 3 piezas
- Para tornillos de cabeza recta y Phillips

Artículo	Cantidad	Paquete	Dimensiones (mm)	Peso (g)
459V-3-1	1	3	35x130x310	35
408V-4-100				
409V-1-150				
429-03-1				

#### DESTORNILLADOR 6 EN 1



- Puntas dobles (6,35 x 65 mm): PH1-5 mm
- Puntas dobles (8 x 75 mm): PH2-6 mm
- Destornillador Stecker: 6, 8 mm

Artículo	Cantidad	Paquete	Longitud (mm)	Longitud (mm)	Longitud (mm)	Peso (g)
475-5-1	1	1/4" / 5/16"	50	110	160	312

### JUEGOS DE DESTORNILLADORES DE SEGURIDAD

#### JUEGO PLANO-PHILLIPS, 6 piezas

IEC 60900 1000V

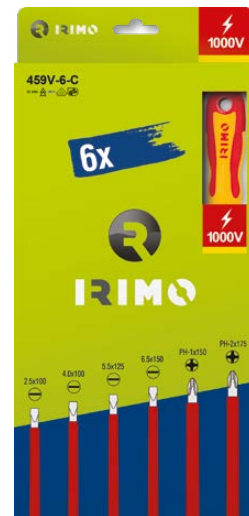
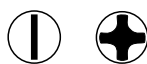

- Para tornillos planos y Phillips
- En caja de cartón

Artículo	Cantidad	Paquete	Dimensiones (mm)	Peso (g)
459V-6-C	1	6	42x325x160	580
408V-2.5-100, 408V-4-100, 408V-5.5-125, 408V-6.5-150				
409V-1-150, 409V-2-175				

#### DESTORNILLADOR REVERSIBLE



- Mango: plástico de alta resistencia a impactos
- Varilla nickelada

Artículo	Cantidad	Paquete	Longitud (mm)	Longitud (mm)	Longitud (mm)	Peso (g)
427411	10	1.2	6	PH-2	156	26





## DESTORNILLADORES MANGOS EN T

### HEXAGONAL



- Varilla: Acero de alta Calidad. Punta negra con mayor precisión
- La longitud de varilla permite aplicar un par controlado y mayor accesibilidad
- La varilla corta del mango a 90° se utiliza para pares muy fuertes o donde zona de trabajo tiene una altura limitada
- Marcado: Tamaño y código marcado por láser en varilla
- Arandela giratoria muy práctica y útil en la base del mango para un giro rápido en la primera fase del apriete

Icono	Icono	Icono	Icono	Icono	Icono	Icono
42-H2-100	5	2	130	100	64x30	23
42-H2.5-100	5	2.5	130	100	64x30	25
42-H3-100	5	3	130	100	64x30	28
42-H4-150	5	4	190	150	80x40	57
42-H5-150	5	5	190	150	80x40	70
42-H6-200	5	6	250	200	100x50	134
42-H8-200	5	8	250	200	100x50	186
42-H10-200	5	10	250	200	100x50	254

### HEXAGONAL BOLA



- Acero de alta calidad. Acabado en negro
- La varilla larga permite un apriete controlado y fácil acceso a los tornillos que requieren profundidad
- La varilla corta de 90° se usa para aprietes fuertes o para trabajar en espacios limitados
- La bola permite introducir la cabeza en el tornillo desde diferentes ángulos
- Más eficiente que el mango en T estándar
- Código y tamaño marcado a láser en varilla para fácil identificación

Icono	Icono	Icono	Icono	Icono	Icono	Icono
42B-H3-100	5	3	130	100	64x30	28
42B-H4-150	5	4	190	150	80x40	57
42B-H5-150	5	5	190	150	80x40	70
42B-H6-200	5	6	250	200	100x50	134
42B-H8-200	5	8	250	200	100x50	186
42B-H10-200	5	10	250	200	100x50	254

### TORX®



- Varilla: Acero de alta Calidad. Punta negra con mayor precisión
- La longitud de varilla permite aplicar un par controlado y mayor accesibilidad
- La varilla corta del mango a 90° se utiliza para pares muy fuertes o donde zona de trabajo tiene una altura limitada
- Marcado: Tamaño y código marcado por láser en varilla
- Arandela giratoria muy práctica y útil en la base del mango para un giro rápido en la primera fase del apriete

Icono	Icono	Icono	Icono	Icono	Icono	Icono	Icono
46-T10-100	5	T10	2.72	130	100	64x30	27
46-T15-150	5	T15	3.26	190	150	80x40	55
46-T20-150	5	T20	3.84	190	150	80x40	55
46-T25-150	5	T25	4.40	190	150	80x40	66
46-T30-200	5	T30	5.49	250	200	100x50	126
46-T40-200	5	T40	6.60	250	200	100x50	147

### LLAVE DE VASO MANGO EN T



- Varilla templada en su total longitud fabricada en acero de alta calidad
- Marcado: Tamaño y código marcado por láser en varilla
- Arandela giratoria muy práctica y útil en la base del mango para un giro rápido en la primera fase del apriete

Icono	Icono	Icono	Icono	Icono	Icono	Icono
191-6-150	5	6	190	150	69x40	78
191-7-175	5	7	225	175	84x50	121
191-8-175	5	8	225	175	84x50	123
191-10-175	5	10	225	175	84x50	160
191-12-175	5	12	225	175	84x50	167
191-13-175	5	13	225	175	84x50	172

## DESTORNILLADORES DE PRECISIÓN

### JUEGO DE 6 DESTORNILLADOR DE PRECISIÓN



- Juego destornilladores de precisión, 6 piezas
- Varillas de acero cromo-vanadio
- Acabado cromado con punta negra para mayor precisión
- Cabeza giratoria
- Sistema de deslizamiento de la caja para abrir y cerrar
- Medidas incluidas:
  - 4 planos: 1,6-2,0-5,5-3,0 mm
  - 2 Phillips: PH00-PH0

461-6-B	1	150	50	120

### DESTORNILLADOR DE PRECISIÓN DE BOLSILLO



478-4-1



478-4-2



- 2 varillas cortas
- 4 puntas: PH0 / 3 mm y PH1 / 4 mm
- Acabado satinado con tratamiento en la punta
- Tamaño de boli con clip incluido para llevarlo fácilmente
- 478-4-2: Expositor de 48 destornilladores doble boca

478-4-2	48	PH0/PH1	120	3.0/4.0	1.100

## COMPROBADOR DE TENSIÓN

### JUEGO 2 DESTORNILLADORES AISLADOS + TESTER



- Comprobadores de tensión de 150-250 V
- Mango: Transparente resistente a impactos
- Varilla: niquelada y protegida hasta la punta
- Fabricado según normativa DIN VDE 0680/6 GS

429-03-1	6	0.6	3.0	65	75	140	30
429-04-1	6	-	3.5	100	90	190	29

## DESTORNILLADOR ACODADO

### JUEGO DE 3 DESTORNILLADORES ACODADOS , 3 piezas



- Incluye 3 destornilladores doble para tornillos ranurados y Phillips
  - Ranurados de 5,0, 6,0 y 8,0 mm
  - Phillips de PH1, PH2 y PH3
- El acabado cromado proporciona una alta protección contra la corrosión
- Acero de alta calidad
- Varilla estriada para un agarre firme
- En blister

420-3-1	1	3	20x230x100	202

## LLAVES TIPO ALLEN CROMADAS, LARGAS

### JUEVO LLAVES TIPO ALLEN CROMADAS PARA TORNILLOS HEXAGONALES, ACABADO EN BOLA, EN MM



- Juego de 9 llaves largas con bola, en mm
- Tamaños marcados en la tapa para su fácil identificación
- Embalaje en blíster

48-9C-H	1	9	1.5-2-2.5-3-4-5-6-8-10 mm 360

## LLAVES TIPO ALLEN PAVONADAS

### JUEGOS LLAVES TIPO ALLEN PAVONADAS, MM



- Juego de 9 llaves hex pavonadas, mm
- Tamaño marcados en el plástico para su fácil identificación
- Embalaje en blíster

46-9-H	1	9	1.5, 2, 2.5, 3, 4, 5, 6, 8, 10 mm 270

### JUEGOS LLAVES TIPO ALLEN PAVONADAS, MM



- Juego de 8 llaves hex pavonadas, mm
- Presentado en navaja
- Permite diversas posiciones de trabajo
- Tope a los 270°, máximo ángulo de giro
- De fácil almacenaje

46-8-F	1	8	1.5, 2.0, 2.5, 3.0, 4.0, 5.0, 6.0, 8.0 mm 160

## LLAVES TIPO ALLEN PAVONADAS, LARGAS

### JUEGO LLAVES TIPO ALLEN LARGAS CON BOLA, MM



- Juego de 9 llaves tipo allen largas con bola, en mm
- Tamaños marcados en la tapa para su fácil identificación
- Embalaje en blíster

48-9-H	1	9	1.5, 2, 2.5, 3, 4, 5, 6, 8, 10 mm	360

### JUEGO LLAVES TIPO ALLEN LARGAS CON BOLA, PULGADAS



- Juego de 13 llaves tipo allen con bola largas, pulgadas
- Tamaños marcados en el plástico para su fácil identificación
- Embalaje en blíster

48A-13-H	1	9	0.05-1/16-5/64-3/32-7/64-1/8-9/64-5/32-3/16-7/32-1/4-5/16-3/8"	360

## LLAVES TIPO ALLEN PAVONADAS TORX®

### JUEGO LLAVES TIPO ALLEN TORX®



- Juego de 9 llaves tipo allen TORX® acabado en negro
- Tamaño marcado en la llave para una fácil identificación
- Agujero para colgar
- Embalaje en blíster

458-9-H	10	9	T10, T15, T20, T25, T27, T30, T40, T45, T50	290

### JUEGO LLAVES TIPO ALLEN TORX®



- Juego en navaja de 8 llaves tipo allen TORX® acabado en negro
- Navaja bi-material resistente a impactos
- Permite trabajar en distintas posiciones
- Tope a 270°, máximo ángulo de giro
- Embalaje en blíster

458-8-F	1	8	T9, T10, T15, T20, T25, T27, T30, T40	160

LLAVES TIPO ALLEN PAVONADAS PARA TORNILLOS TORX® INVIOABLES

JUEGO LLAVES TIPO ALLEN PAVONADAS TORX® INVIOABLES, 9 piezas



- Juego de 9 llaves tipo allen pavonadas TORX® inviolables
- Medida marcada en la llave para una fácil identificación
- Agujero para colgar
- Embalaje en blíster

454-9-H	10	9	TR10, TR15, TR20, TR25, TR27, TR30, TR40, TR45, TR50	290

JUEGO LLAVES TIPO ALLEN PAVONADAS TORX® INVIOABLES



- Juego llaves tipo allen TORX® inviolable, 8 piezas
- Petaca bi-material resistente a impactos
- Permite trabajar en diferentes posiciones
- Tope a 270°, máximo ángulo de giro
- Embalaje en blíster

454-8-F	1	8	TR9, TR10, TR15, TR20, TR25, TR27, TR30, TR40	160

## PUNTAS 1/4" PARA ATORNILLADOR

## PUNTAS 1/4" PLANA, 25 MM



x10



- Cuadrado: 1/4" DIN 3126-C 6,3, ISO 1173
- Caja de plástico de 10 uds.

Artículo	Caja	Ø mm	L mm	L mm	g
475-6.0-1	1	1.0	6.0	25	35
475-6.5-1	1	1.2	6.5	25	35

## PUNTAS 1/4" PHILLIPS, 25 MM



x10



- Específicos para utilizar en trabajos con yeso
- Diámetro reducido Ø 4,8 mm
- Cuadrado: 1/4" DIN 3126-C 6,3, ISO 1173
- Caja de plástico de 10 uds.

Artículo	Caja	Tip	L mm	g
475-PH2G-1	1	PH-2G	25	35

## PUNTAS 1/4" PHILLIPS, 25 MM



x10



- Cuadrado: 1/4" DIN 3126-C 6,3, ISO 1173
- Caja de plástico de 10 uds.

Artículo	Caja	Tip	L mm	g
475-PH0-1	1	PH-0	25	35
475-PH1-1	1	PH-1	25	35
475-PH2-1	1	PH-2	25	35
475-PH3-1	1	PH-3	25	35

## PUNTAS 1/4" POZIDRIV, 25 MM



x10



- Cuadrado: 1/4" DIN 3126-C 6,3, ISO 1173
- Caja de plástico de 10 uds.

Artículo	Caja	Tip	L mm	g
475-PZ0-1	1	PZ-0	25	35
475-PZ1-1	1	PZ-1	25	35
475-PZ2-1	1	PZ-2	25	35
475-PZ3-1	1	PZ-3	25	35

## PUNTAS 1/4" TORX®, 25 MM



x10



- Cuadrado: 1/4" DIN 3126-C 6,3, ISO 1173
- Caja de plástico de 10 uds. (T30/T40 en caja de 5 uds.)

Artículo	Caja	Tip	Ø mm	L mm	g
475-T5-1	1	T5	1.70	25	30
475-T6-1	1	T6	1.70	25	30
475-T7-1	1	T7	1.99	25	35
475-T8-1	1	T8	2.31	25	35
475-T9-1	1	T9	2.50	25	35
475-T10-1	1	T10	2.74	25	35
475-T15-1	1	T15	3.27	25	35
475-T20-1	1	T20	3.86	25	35
475-T25-1	1	T25	4.43	25	35
475-T27-1	1	T27	4.99	25	35
475-T30-1	1	T30	5.52	25	40
475-T40-1	1	T40	6.65	25	50
475-T45-1	1	T45	7.90	25	70
475-T50-1	1	T50	7.94	25	80

## PUNTAS 1/4" TORX® INVOLABLES, 25 MM



x5



- Cuadrado: 1/4" DIN 3126-C 6,3, ISO 1173
- Caja de plástico de 5 uds.

Artículo	Caja	Tip	Ø mm	L mm	g
475-TR10-1	1	T10	2.74	25	35
475-TR15-1	1	T15	3.27	25	35
475-TR20-1	1	T20	3.86	25	35
475-TR25-1	1	T25	4.43	25	35
475-TR27-1	1	T27	4.99	25	35
475-TR30-1	1	T30	5.52	25	40
475-TR40-1	1	T40	6.65	25	50

PUNTAS 1/4" PARA ATORNILLADOR

JUEGO DE 5 PUNTAS STECKER MAGNÉTICAS



- Juego de 5 puntas stecker magnéticas
- Cuadradillo 1/4" DIN 3126 E 6.3 ISO 1173
- Acero aleado de alto rendimiento
- Con imán fuerte
- Vaso hexagonal
- Embalaje en blíster

Part Number	Quantity	Weight (g)	Icon 1	Icon 2
474M-5-H	1	5	134	
474M-5.5-1, 474M-7-1, 474M-8-1, 474M-10-1, 474M-13-1				

JUEGOS DE PUNTAS 1/4"

JUEGO, 32 piezas



- DIN 3126-C 6,3, ISO 1173
- En blíster
- Display 8 juegos: 475-32-8 Disp

Part Number	Quantity	Weight (g)	Dimensions	Icon
475-32-1	1	32	30x105x65	275
475-32-8DISP	1	8	360x340x260	2.240
475-4.5-1, 475-4-1, 475-5.5-1				
2x 475-PH1-1, 2x 475-PH2-1, 2x 475-PH3-1				
475-PH2G-1				
2x 475-PZ1-1, 2x 475-PZ2-1, 2x 475-PZ3-1				
475-T10-1, 2x 475-T15-1, 2x 475-T20-1, 2x 475-T25-1, 475-T27-1, 2x 475-T30-1, 475-T40-1				
475-H3-1, 475-H4-1, 475-H5-1, 475-H6-1				
475A-25-1				
105-48-1				
475A-60QR-1				

JUEGO, 61 piezas



- DIN 3126-C 6,3, ISO 1173
- Envasado en blíster

Part Number	Quantity	Weight (g)	Dimensions	Icon
475-61-1	1	61	35 x 148 x 112	549
475-4.5-1, 475-4-1, 475-5.5-1, 475-6.0-1, 475-6.5-1, 475-8.0-1				
475-PH0-1, 2x 475-PH1-1, 3x 475-PH2-1, 2x 475-PH3-1				
2x 475-PH2G-1				
475-PZ0-1, 2x 475-PZ1-1, 3x 475-PZ2-1, 2x 475-PZ3-1				
475-T6-1, 475-T7-1, 475-T8-1, 475-T9-1, 2x 475-T10-1, 2x 475-T15-1, 3x 475-T20-1, 2x 475-T25-1, 2x 475-T27-1, 2x 475-T30-1, 2x 475-T40-1				
475-TR10-1, 475-TR15-1, 475-TR20-1, 475-TR25-1, 475-TR27-1, 475-TR30-1, 475-TR40-1				
475-H3-1, 475-H4-1, 475-H5-1, 475-H6-1				
475A-25-1				
R-1, R-2, R-3				
475A-60QR-1				

VASOS CON PUNTA 1/2"

JUEGO, 49 piezas



- Acabado zinc fosfatado
- Caja metálica

Part Number	Quantity	Weight (g)	Dimensions (mm)	Weight (g)	Image
T49	1	49	60 x 325 x 195	3.600	
T4901					
T4902					
T49T30XL, T49T40XL, T49T45XL, T49T70HL, T49T80HL					
T49H4, T49H4L, T49H5, T49H5L, T49H6, T49H6L, T49H7, T49H7L, T49H8, T49H8L, T49H10, T49H10L, T49H12, T49H12L					
T49M5, T49M5L, T49M6, T49M6L, T49M8, T49M8L, 49M10, T49M10L, T49M12, T49M12L					
T49T20H, T49T20HL, T49T25H, T49T25HL, T49T27H, T49T27HL, T49T30H, T49T30HL, T49T40H, T49T40HL, T49T45H, T49T45HL, T49T50H, T49T50HL, T49T55H, T49T55HL, T49T60H, T49T60HL					

1



2



3



4



5



6



7



8



9



10



11



12





GOLPEO

JUEGOS DE GRANETES REDONDOS



IRIMO	Paquete	Contenido	Tamaño	Peso (g)
511-91-4	1	4	2.5 - 4 - 6 - 8 mm	234
511-92-4	1	5	2.5 - 4 - 5 - 6 - 8 mm	275

JUEGO DE BOTADORES CÓNICOS



IRIMO	Paquete	Contenido	Tamaño	Peso (g)
513-91-4	1	5	2 - 4 - 6 - 8 - 10 mm	502
513-92-4	1	7	2 - 3 - 4 - 5 - 6 - 8 - 10 mm	602

JUEGO DE BOTADORES CÓNICOS, PERFIL OCTOGONAL



IRIMO	Paquete	Contenido	Tamaño	Peso (g)
519-91-4	1	6	150x80x12	409
2-3-4-5-6 mm				
4 mm				

JUEGO BOTADORES CILÍNDRICOS



IRIMO	Paquete	Contenido	Tamaño	Peso (g)
515-91-4	1	9	2 - 3 - 4 - 5 - 6 - 7 - 8 - 9 - 10 mm	622

JUEGO BOTADORES CILÍNDRICOS, PERFIL OCTOGONAL



IRIMO	Paquete	Contenido	Tamaño	Peso (g)
519-92-4	1	6	2 - 3 - 4 - 5 - 6 - 8 mm	409

JUEGO BOTADORES CILÍNDRICOS, SERIE LARGA



517-91-4	1	6	2-3-4-5-6-8 mm	355

JUEGO BOTADORES Y CINCELES, 6 piezas



519-93-4	1	6	160x85x12	600

504-150-1	
506-150-1	
512-010-1	
514-003-1, 514-004-1	
516-005-1	

TRAZADOR PUNTA DURA



- Adecuado para el marcado en superficies duras
- Longitud total 150 mm

		<b>L</b> mm	
511501	1	150	39



MARTILLOS

MARTILLO DE CARPINTERO CON MANGO DE FIBRA



- Mango encolado a la cabeza
- Mango trimaterial con el interior de fibra y recubierto de polipropileno y elastómero para un buen agarre

R	Paquete	oz	g	A mm	B mm	L mm	g
520-43-2	6	16	450	29	130	330	710
520-63-2	6	20	560	30	140	333	820

MARTILLO DE CARPINTERO DE BOLSILLO



- Cabeza pegada al mango con resina especial
- Mango trimaterial con el interior de fibra y recubierto de polipropileno y elastómero para un buen agarre
- Alojamiento en la cabeza imantado para clavos

R	Paquete	oz	g	A mm	B mm	L mm	g
520-13S-1	6	8	227	23	105	160	300

MARTILLO DE PEÑA CON MANGO DE FIBRA VIDRIO



- Mango encolado a la cabeza
- Mango trimaterial con el interior de fibra y recubierto de polipropileno y elastómero para un buen agarre

R	Paquete	g	A mm	B mm	L mm	g
522-23-2	12	170	20	91	282	270
522-33-2	6	270	25	107	291	380
522-43-2	6	460	30	120	311	680

MARTILLO DE BOLA CON MANGO FIBRA DE VIDRIO



- Mango encolado a la cabeza
- Mango trimaterial con el interior de fibra y recubierto de polipropileno y elastómero para un buen agarre

R	Paquete	oz	g	A mm	B mm	L mm	g	
527-33-2	6	B	12	340	27	90	317	500
527-43-2	6	C	16	455	30	100	320	600
527-53-2	6	D	20	560	33	108	324	760
527-63-2	6	E	24	680	35	120	335	920
527-73-2	6	F	32	910	37	131	337	1.148

MAZA DE GOMA



- Para colocación de suelos y paredes

R	Paquete	A mm	B mm	L mm	g
529251	1	55	90	320	250
529261	1	65	115	340	440
529271	1	75	125	360	600
529291	1	90	139	360	720

MARTILLO ANTIRREBOTE



- Mango de madera

Q		S mm	A mm	L mm	g
529611	6	35	115	370	500
529621	6	50	120	390	1.000
529631	6	60	125	420	1.560

BOCAS DE REPUESTO PARA MARTILLO ANTIRREBOTE



- Compatible con martillos 529801-529821

Q		A mm	L mm	g
529701	6	25	35	20
529711	6	28	50	50
529721	6	30	60	60

MARTILLO BOCA NYLON



- Mango metálico, empuñadura de caucho

Q		S mm	A mm	L mm	g
529021	6	28	80	255	325
529031	6	35	100	285	650
529041	6	44	125	300	1.105

MARTILLO BOCA NYLON



- Mango de madera

Q		S mm	A mm	L mm	g
529151	6	22	65	215	145
529161	6	28	80	270	260
529171	6	35	100	295	500
529181	6	44	125	345	1.010
529191	6	55	140	380	1.480

BOCAS DE REPUESTO PARA MARTILLO BOCA NYLON



- Compatible con martillos 529751-529791

Q		A mm	L mm	Ø mm	g
529061	10	12	22	8	10
529071	10	19	28	9	15
529081	10	22	35	10	20
529091	10	27	44	13	50
529101	10	32	55	16	80

MANGO DE MADERA PARA MARTILLO BOCA NYLON



- Compatible con martillos 529751-529791

Q			g
529751	1	529151	50
529761	1	529161	70
529771	1	529171	100
529781	1	529181	150
529791	1	529191	170



## FORMONES

### JUEGO 3 FORMONES



- Mango mono material de polipropileno
- Acero Cr-V de alta calidad templado a 58±60 HRc
- Hojas rectificadas de precisión con máximo afilado
- Protector en la punta incluido

805-3-C	1	3	12, 18, 25 mm	589

### JUEGO 6 GUBIAS PARA TALLA



- Juego de gubias para talla, 6 piezas
- Mango de madera
- Varillas de acero cromo-vanadio de alta calidad
- Dureza hasta 55 HRc para garantizar la durabilidad y el mantenimiento
- Acabado con recubrimiento anti óxido
- Medidas: 160 mm

806-6-B	1	6	160	221

	Cinzel cuadrado 12 mm
	Cinzel corte inclinado 12 mm
	Gubia curvada 6,5 mm
	Gubia recta 5 mm
	Gubia curvada 5 mm
	Gubia curvada 12 mm

ALICATES

ALICATE CORTANTE

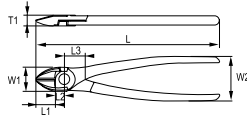

- Acero de alto rendimiento
- Dureza de corte 60-65 HRc
- ISO 5749
- Capacidad de corte:
  - 1- Alambre cobre: 0,50 mm
  - 2- Alambre semi duro: 1,60 mm

R	Icono	L mm	L1 mm	L2 mm	L3 mm	W1 mm	W2 mm	T1 mm	Icono	Icono	g
624-140-1	5	142	20.5	6	12	18.6	50	10	Ø 0.5 mm	Ø 1.6 mm	170
624-160-1	5	160	21.5	7	13	21.6	50	11.5	Ø 0.5 mm	Ø 1.6 mm	200
624-180-1	5	176	24.5	7	14	25.6	50	12.5	Ø 0.5 mm	Ø 1.6 mm	250

ALICATE UNIVERSAL

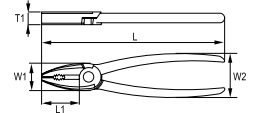

- Acero de alto rendimiento
- Dureza de corte 58-65 HRc
- ISO 5746
- Capacidad de corte:
  - 1- Alambre cobre: 1,00 mm
  - 2- Alambre semi duro: 1,60-2,00-2,50 mm

R	Icono	L mm	L1 mm	W1 mm	W2 mm	T1 mm	Icono	Icono	g
601-160-1	5	160	35	24	50	10	Ø 1.0 mm	Ø 1.6 mm	190
601-180-1	5	180	38	27	50	10	Ø 1.0 mm	Ø 2.0 mm	240
601-200-1	5	197	41.5	29.5	50	10	Ø 1.0 mm	Ø 2.5 mm	300

ALICATE BOCA SEMIRREDONDA

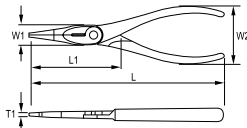

- Acero de alto rendimiento
- Dureza de corte 58-65 HRc
- ISO 5745
- Capacidad de corte:
  - 1- Alambre cobre: 1,00 mm
  - 2- Alambre semi duro: 1,60 mm

R	Icono	L mm	L1 mm	W1 mm	W2 mm	T1 mm	Icono	Icono	g
612-160-1	5	161	61.5	16.5	49	10	Ø 1.0 mm	Ø 1.6 mm	140
612-200-1	5	201	78	18	50	10.5	Ø 1.0 mm	Ø 1.6 mm	180

ALICATE BOCA SEMIRREDONDA CURVA

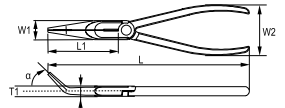

- Acero de alto rendimiento
- Dureza de corte 58-65 HRc
- ISO 5745
- Capacidad de corte:
  - 1- Alambre cobre: 1,00 mm
  - 2- Alambre semi duro: 1,60 mm

R	Icono	L mm	L1 mm	W1 mm	W2 mm	T1 mm	alpha	Icono	Icono	g
613-160-1	5	158	48	18	50	9.0	45°	Ø 1.0 mm	Ø 1.6 mm	132
613-200-1	5	197	74	18	50	10.5	45°	Ø 1.0 mm	Ø 1.6 mm	180

ALICATE BOCA PLANA

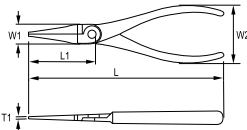

- Acero de alto rendimiento templado a 45-50 HRc
- ISO 5745

R	Icono	L mm	L1 mm	W1 mm	W2 mm	T1 mm	g
604-160-1	5	158	48	17	48	9	150
604-180-1	5	180	50	20	50	11	175

ALICATE BOCA REDONDA

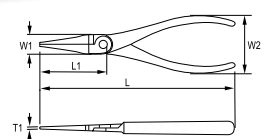

- Acero de alto rendimiento templado a 45-50 HRc
- ISO 5745

R	Icono	L mm	L1 mm	W1 mm	W2 mm	T1 mm	g
608-160-1	5	158	38	17	48	8.5	150

PINZA AJUSTE RÁPIDO

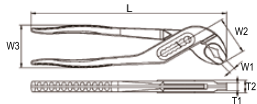

- Con botón para un ajuste rápido
- Acero de alto rendimiento
- Dientes templados a 50-57 HRc
- ISO 8976

634Q-250-1	5	240	5	47.5	50	7.5	12.5	320
------------	---	-----	---	------	----	-----	------	-----

JUEGOS ALICATES

JUEGO ALICATES



- Mangos bi-materiales

601-3-C	1	3	270 x 205 x 40	690
601-180-1		624-160-1		
612-200-1				

JUEGO ALICATES Y PINZA



- Mangos bi-materiales

602-3-C	1	3	270 x 205 x 40	850
601-180-1		624-160-1		
634-250-1				

ALICATES PARA ELECTRICISTA

ALICATE PELACABLES

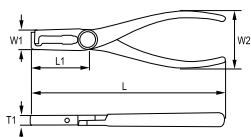

- Acero de alto rendimiento
- Templado a 45-50 HRc

629-160-1	5	160	40.5	19	48	9	1-6	170
-----------	---	-----	------	----	----	---	-----	-----

ALICATE CORTANTE PARA COBRE Y ALUMINIO

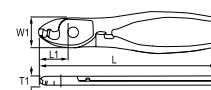

- Alicates para cortar y pelar cables de cobre y aluminio
- Acabado: Las superficies forjadas tienen un acabado fosfatado y pulido
- Material: Acero al carbono, mangos recubiertos de PVC

655-160-1	5	160	25	25	10	50/35	10	160
655-200-1	5	200	28	30	12	70/50	13	280

**ALICATES PARA ELECTRICISTA**

**ALICATE PARA TERMINALES AISLADOS**

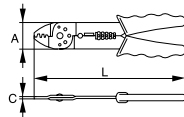

- Alicates para cortar, pelar y engastar terminales aislados
- Fabricados en acero templado
- Prensa terminales: 1,5/2,5/6 mm<sup>2</sup>
- Corta cables: M2.6-M5.0
- Capacidad de pelado: 0,75-6,0 mm<sup>2</sup>

R	Icono	L	A	C	mm <sup>2</sup>	AWG	mm <sup>2</sup>	AWG	mm <sup>2</sup>	g	
630-B1-1		12	220	38	3	1.5-6.0	20-10	0.75-6.0	20-10	0.75-6.00	220

**ALICATE PARA TERMINALES NO AISLADOS**

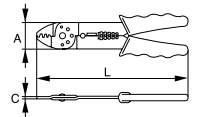

- Alicates para cortar, pelar y engastar terminales no aislados
- Fabricados en acero templado
- Prensa terminales: 1,5/2,5/6 mm<sup>2</sup>
- Corta cables: M2.6-M5.0
- Capacidad de pelado: 0,75-6,0 mm<sup>2</sup>

R	Icono	L	A	C	mm <sup>2</sup>	AWG	mm <sup>2</sup>	AWG	mm <sup>2</sup>	g	
630-B2-1		12	220	38	3	1.5-6.0	14-10	0.75-6.0	18-12	0.75-6.00	220

**ALICATE PARA TERMINALES NO AISLADOS TIPO FASTON**

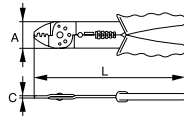

- Alicates para cortar, pelar y engastar terminales no aislados Tipo Faston
- Fabricados en acero templado
- Prensa terminales: 1,5/2,5/6 mm<sup>2</sup>
- Corta cables: M2.6-M5.0
- Capacidad de pelado: 0,75-6,0 mm<sup>2</sup>

R	Icono	L	A	C	mm <sup>2</sup>	AWG	mm <sup>2</sup>	AWG	mm <sup>2</sup>	g	
630-B3-1		12	220	38	3	1.5-6.0	14-10	0.75-6.0	18-12	0.75-6.00	220

**JUEGO DE ALICATE PARA TERMINALES AISLADOS CON 60 TERMINALES**



- Juego con alicate para cortar, pelar y engastar terminales aislados y 60 terminales aislados
- Fabricados en acero templado
- Prensa terminales: 1,5/2,5/6 mm<sup>2</sup>
- Corta cables: M2.6-M5.0
- Capacidad de pelado: 0,75-6,0 mm<sup>2</sup>

R	Icono	L	A	C	mm <sup>2</sup>	AWG	mm <sup>2</sup>	AWG	mm <sup>2</sup>	g
630-61B1-4		1	60+1	24 x 160 x 270						370



## ALICATES SEGURIDAD

### ALICATE UNIVERSAL AISLADO

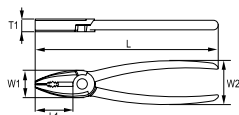

- Para trabajos en baja tensión hasta 1000 V
- Acero de alto rendimiento
- Dureza de corte 58-65 HRc
- ISO 5746
- Capacidad de corte:
  - 1- Alambre cobre: 1,00 mm
  - 2- Alambre semi duro: 1,60-2,00-2,50 mm

Q	Icono	L mm	L1 mm	W1 mm	W2 mm	T1 mm	1 mm	2 mm	g
601V-160-1	5	160	35	24	50	10	Ø 1.0 mm	Ø 1.6 mm	190
601V-180-1	5	180	38	27	50	10	Ø 1.0 mm	Ø 2.0 mm	240
601V-200-1	5	197	41.5	29.5	50	11	Ø 1.0 mm	Ø 2.5 mm	300

### ALICATE BOCA PLANA AISLADO

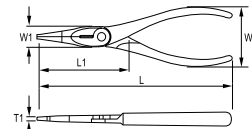

- Para trabajos en baja tensión hasta 1000 V
- Acero de alto rendimiento
- Dureza de corte 58-65 HRc
- ISO 5745

Q	Icono	L mm	L1 mm	W1 mm	W2 mm	T1 mm	g
604V-160-1	5	158	48	17	50	9	150

### ALICATE BOCA SEMIRREDONDA AISLADO

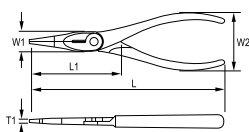

- Para trabajos en baja tensión hasta 1000 V
- Dureza de corte 58-65 HRc
- ISO 5746
- Capacidad de corte:
  - 1- Alambre cobre: 1,00 mm
  - 2- Alambre semi duro: 1,60 mm

Q	Icono	L mm	L1 mm	W1 mm	W2 mm	T1 mm	1 mm	2 mm	g
612V-160-1	5	161	61.5	16.5	49	10	Ø 1.0 mm	Ø 1.6 mm	140
612V-200-1	5	201	78	18	50	10.5	Ø 1.0 mm	Ø 1.6 mm	180

### ALICATE BOCA SEMIRREDONDA CURVA AISLADO

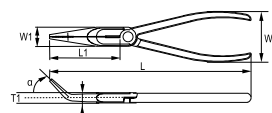

- Para trabajos en baja tensión hasta 1000 V
- Acero de alto rendimiento
- Dureza de corte 58-65 HRc
- ISO 5745
- Capacidad de corte:
  - 1- Alambre cobre: 1,00 mm
  - 2- Alambre semi duro: 1,60 mm

Q	Icono	L mm	L1 mm	W1 mm	W2 mm	T1 mm	α	1 mm	2 mm	g
613V-160-1	5	158	50	18	18	9.0	45°	Ø 1.0 mm	Ø 1.6 mm	132
613V-200-1	5	197	74	18	50	10.5	45°	Ø 1.0 mm	Ø 1.6 mm	180

ALICATES SEGURIDAD

ALICATE CORTANTE AISLADO

IEC 60900

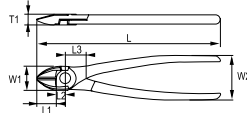

- Para trabajos en baja tensión hasta 1000 V
- Acero de alto rendimiento
- Dureza de corte 60-65 HRC
- ISO 5749
- Capacidad de corte:
  - 1- Alambre cobre: 0,50 mm
  - 2- Alambre semi duro: 1,60 mm

Modelo	P	L (mm)	L1 (mm)	L2 (mm)	L3 (mm)	W1 (mm)	W2 (mm)	T1 (mm)	1 mm	2 mm	g
624V-140-1	5	142	20.5	7	13	18.6	50	10.0	Ø 0.5 mm	Ø 1.6 mm	170
624V-160-1	5	155	21.5	7	13	21.6	50	11.5	Ø 0.5 mm	Ø 1.6 mm	200

ALICATE CORTANTE REFORZADO AISLADO

IEC 60900

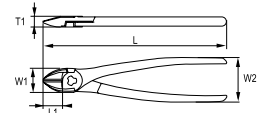

- Para trabajos en baja tensión hasta 1000 V
- Acero de alto rendimiento
- Dureza de corte 60-65 HRC
- ISO 5749
- Capacidad de corte:
  - 1- Alambre cobre: 0,50 mm
  - 2- Alambre semi duro: 1,80 mm

Modelo	P	L (mm)	L1 (mm)	W1 (mm)	W2 (mm)	T1 (mm)	1 mm	2 mm	g
625V-180-1	5	180	20.5	25.6	49	11.5	Ø 0.5 mm	Ø 1.8 mm	280

ALICATE PELACABLES AISLADO

IEC 60900

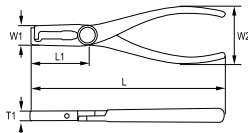

- Para trabajos en baja tensión hasta 1000 V
- Acero de alto rendimiento
- 45-50 HRC

Modelo	P	L (mm)	L1 (mm)	W1 (mm)	W2 (mm)	T1 (mm)	1-6	g
629V-160-1	5	160	40.5	19	48	9	1-6	170

TENACILLA AISLADA

IEC 60900

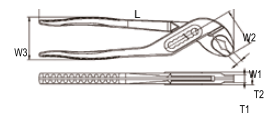

- Para trabajos en baja tensión hasta 1000 V
- Acero de alto rendimiento
- Dientes templados a 50-57 HRC
- ISO 8976

Modelo	P	L (mm)	W1 (mm)	W2 (mm)	W3 (mm)	T1 (mm)	T2 (mm)	g
634V-250-1	5	240	5	47.5	50	7.5	12.5	310

JUEGOS ALICATES SEGURIDAD

JUEGO DE ALICATES AISLADOS

IEC 60900



- Para trabajos en baja tensión hasta 1000 V
- Acero de alto rendimiento
- IEC 60900

Modelo	P	X	g	
601V-3-C	1	3	270 x 205 x 40	690
624V-160-1			601V-180-1	
612V-200-1				

### CORTAVARILLAS

#### CORTAVARILLAS



- Acero de alta resistencia
- Cuchillas con doble tratamiento térmico
- Acabado pavonado

Q	Icono	L mm	A mm	B mm	Ø 80 kg/mm <sup>2</sup>	Ø 160 kg/mm <sup>2</sup>	Ø 120 kg/mm <sup>2</sup>	g	
651101	1	N.0	320	48	77	5	4	3	500
651111	1	N.1	470	66	104	7	6	5	1.785
651121	1	N.2	630	85	137	9	8	7	2.860
651131	1	N.3	750	100	160	11	9	8	4.410
651141	1	N.4	900	120	182	13	10	9	5.800

### TENAZAS

#### TENAZA DE ENCOFRADOR CON MANGOS PVC

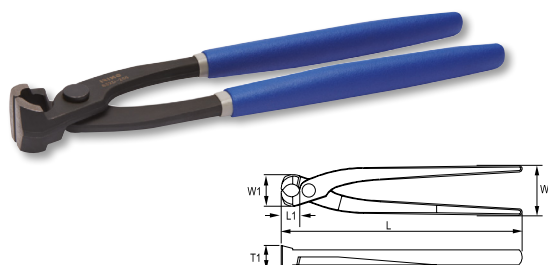

- Mangos recubiertos de PVC azul
- Dureza: dientes endurecidos a 58-68 HRC
- ISO 9242
- Capacidad de corte: 1,60 mm

Q	Icono	L mm	L1 mm	W1 mm	W2 mm	T1 mm	Icono	g
632D-250-1	5	250	18	33	46	24.5	1.6 mm	400

### TIJERAS CORTACHAPAS

#### CORTE RECTO



- Mandíbulas de acero cromo molibdeno forjadas para mayor resistencia
- Filos fresados con precisión
- Suave acción de corte y gran poder de agarre. Sistema palanca
- Mangos con doble inyección con zona antideslizante y muelle de retorno que mejora en confort
- Capacidad de corte: 1- Acero inox, 2- Acero laminado en frío

Q	Icono	L mm	1 mm	2 mm	g
658-250-1	1	250	0.7	1.2	390

#### CORTE DERECHA



- Mandíbulas de acero cromo molibdeno forjadas para mayor resistencia
- Filos fresados con precisión
- Suave acción de corte y gran poder de agarre. Sistema palanca
- Mangos con doble inyección con zona antideslizante y muelle de retorno que mejora en confort
- Capacidad de corte: 1- Acero inox, 2- Acero laminado en frío

Q	Icono	L mm	1 mm	2 mm	g
659-250-1	1	250	0.7	1.2	395

#### CORTE IZQUIERDA



- Mandíbulas de acero cromo molibdeno forjadas para mayor resistencia
- Filos fresados con precisión
- Suave acción de corte y gran poder de agarre. Sistema palanca
- Mangos con doble inyección con zona antideslizante y muelle de retorno que mejora en confort
- Capacidad de corte: 1- Acero inox, 2- Acero laminado en frío

Q	Icono	L mm	1 mm	2 mm	g
660-250-1	1	250	0.7	1.2	405

**ALICATES PARA ANILLOS O ARANDELAS**

**ALICATE RECTO PARA ANILLOS INTERIORES**



- Acabado pavon para protección contra la corrosión
- Acero aleado de alto rendimiento
- Dureza 45-50 HRc
- Puntas forjadas rectas
- DIN 5256

Q	Icono	L mm	B mm	E mm	Icono	Icono	g
621571	5	180	57	1.7	19 - 60	1	170
621581	5	225	69	2.2	40 - 100	1	275

**ALICATE CURVO PARA ANILLOS INTERIORES**



- Acabado pavon para protección contra la corrosión
- Acero aleado de alto rendimiento
- Dureza 45-50 HRc
- Puntas forjadas curvadas
- DIN 5256

Q	Icono	L mm	B mm	E mm	Icono	Icono	g
621681	5	208	52	2,2	40 - 100	1	275

**ALICATE RECTO PARA ANILLOS EXTERIORES**



- Acabado pavon para protección contra la corrosión
- Acero aleado de alto rendimiento
- Dureza 45-50 HRc
- Puntas forjadas rectas
- Muelle interno
- DIN 5254

Q	Icono	L mm	B mm	E mm	Icono	Icono	g
621771	5	180	57	1.7	19 - 60	1	170
621781	5	225	69	2.2	40 - 100	1	275

**ALICATE CURVO PARA ANILLOS EXTERIORES**



- Acabado pavon para protección contra la corrosión
- Acero aleado de alto rendimiento
- Dureza 45-50 HRc
- Puntas forjadas curvadas
- Muelle interno
- DIN 5254

Q	Icono	L mm	B mm	E mm	Icono	Icono	g
621881	5	208	52	2.2	40 - 100	1	275

**JUEGO DE ALICATES**



- Acabado pavon para protección contra la corrosión
- Acero aleado de alto rendimiento
- Dureza 45-50 HRc
- Puntas forjadas
- DIN 5254

Q	Icono	Icono	Icono	g
601911	1	4	260 x 220 x 30	750

621571	Icono	Icono	621671	Icono	Icono
621771	Icono	Icono	621871	Icono	Icono

GRIPS

MORDAZA UNIVERSAL, BOCAS CURVAS CON CORTANTE



- Uso general, sujeción de barras, chapas, tuercas y tornillos
- Bocas fuertes, forjadas
- Acero de cromo molibdeno
- Niquelado

Q		A	B	C	D	E	F	G	Fe <sup>+</sup> mm	g
	mm	mm	mm	mm	mm	mm	mm	mm		
64A-235-1	225	38	48	12	0-35	7	6	3	543	556

JUEGO DE MORDAZAS GRIP



- Mango bi-material de agarre suave
- Bolsa nylon enrollable

Q		X	g
648-4-W	1	4	1.200
648-140-1, 648-185-1, 648-250-1			
648-165-1			

REMACHADORA

REMACHADORA MANUAL



- Remachadora de cuatro boquillas intercambiables para medidas de remachado: 1,8-2,2-2,8-3,2 mm
- Para uso en aluminio, acero, acero inoxidable y cobre
- Incluye una llave para cambio de boquillas

Q		L	A	B	g
		mm	mm	mm	
546-265-1	1	265	90	25	700



546-265-A



546-265-B

Repuestos para remachadora 546-265-1		
546-265-A	Juego componentes de las mordazas	1
546-265-B	Juego 4 boquillas	1

REMACHADORA DE TUERCAS CON TUERCAS



- 265 mm remachadora de uso general con cuatro cabezas intercambiables diferentes
- Para remaches de 2,4 mm; 3,0 a 3,2 mm; 4,0 mm y 4,8 mm
- Incluye una llave para cambiar las cabezas
- Para utilizar con aluminio, acero, acero inoxidable y remaches de cobre
- 160 remaches (40 de cada tamaño)
- Estuche de plástico

Q		X		g
546-265-4	1	160	300 x 210 x 60	1.200

CUCHILLOS

TRINCHETA, 9 MM



85x9x0.50 mm

667-135-1	12	133	56

TRINCHETA, 18 MM

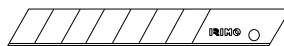

112x18x0.50 mm

666-156-1	12	157	106

TRINCHETA, 18 MM



60x19x0.635 mm



- Hoja autorretráctil para mayor seguridad

668-150-1	12	150	157

CUCHILLO DE SEGURIDAD

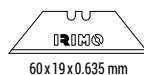

60x19x0.635 mm



- Cuchillo de seguridad
- Hoja retráctil

669-175-1	10	175	210

RASQUETA PARA VIDRIO CON CUCHILLAS INTERCAMBIABLES

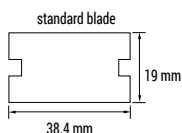

38.4 mm

19 mm



- Ideal para eliminar pintura, pegamento, pegatinas o masilla de cristales, azulejos, paredes, suelos y otras superficies suaves
- Diseño ergonómico en dos materiales
- Sistema de retracción de la cuchilla para un almacenamiento seguro
- Compartimento con 5 cuchillas incluidas
- Medida adaptada a la palma de la mano, 130 mm
- Hojas estándar de 40 mm

538-140-1	1	135	65

**CUCHILLO PLEGABLE**



- Hoja de acero inoxidable 3Cr13
- Mango de acero inoxidable 106 mm
- Ligero y cómodo
- Incluye gancho para cinturón
- Longitud total: 178 mm
- Grosor de la hoja: 2,3 mm

R		A mm	L mm	g
670-178-1	10	78	178	120

**CUCHILLO PLEGABLE**



- Hoja de acero inoxidable 3Cr13
- Mango negro 113 mm
- Ligero y cómodo
- Incluye gancho para cinturón
- Longitud total: 190 mm
- Grosor de la hoja: 2,63 mm

R		A mm	L mm	g
669-190-1	10	77	190	130

**CUCHILLO DE ELECTRICISTA**



- Navaja de bolsillo para electricista con función pelacables, mango de madera

R		A mm	L mm	g
664-200-1	10	85	200	83

**CUCHILLO DE ELECTRICISTA**



- Navaja de bolsillo para electricista de acero inoxidable con función pelacables, mango de plástico

R		A mm	L mm	g
665-200-1	10	85	200	60

**MULTIHERRAMIENTAS**



- Multiherramienta plegable de acero inoxidable 3Cr13
- Longitud: 96 mm cerrada / 150 mm en total
- Estuche incluido para fácil transporte
- Incluye:
  - Tenaza
  - Alicata universal
  - Corta cables
  - Cuchillo
  - 5 Destornilladores planos
  - Abre latas
  - Sierra
  - Lima para madera y metal
  - Abre botellas
  - Tijeras
  - Destornillador Phillips

R		L mm	g
671-150-1	10	150 (96)	255



TIJERAS Y NAVAJAS DE ELECTRICISTA

TIJERAS DE ELECTRICISTA



- Tijeras de electricista con plástico protector para los dedos
- Curvatura en la hoja para pelar cables de hasta 43 mm

€		A mm	L mm	
661051	10	42.5	130	70

TIJERAS DE ELECTRICISTA



- Tijeras de electricista reforzada con plástico protector para los dedos
- Curvatura en la hoja para pelar cables con mayor accesibilidad
- Capacidad de corte 38 mm
- Menor esfuerzo de corte

€		A mm	L mm	
661061	10	38	152	130

GANCHOS

JUEGO 4 GANCHOS, BI-COMPONENTE



- Para rascar, manipular o quitar anillos, muelles, soldaduras, etc.
- Largura: 170 mm
- Mango ligero bi-componente
- Material: Varillas de acero al carbono, puntas endurecidas 40 HRc
- Composición:
  - 1 Pico recto,
  - 1 gancho angulado 45°,
  - 1 gancho 90° y
  - 1 gancho completo

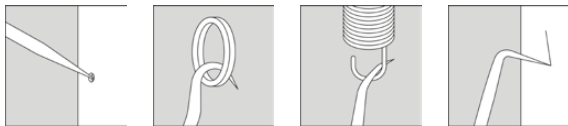

€				
722-4-1	12	4	20 x 230 x 130	100



EXTRACTORES

EXTRACTOR UNIVERSAL DE 2 BRAZOS

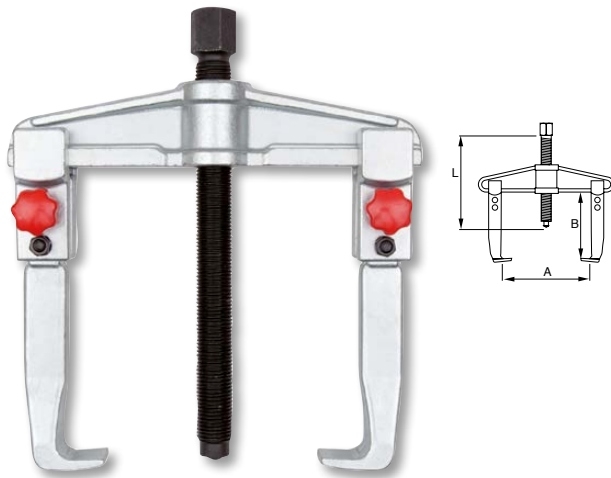

- Cuerpo y brazos fabricados en acero forjado
- Perfil con forma de viga, ligero y resistente
- Acabado galvanizado, con husillo templado por inducción
- Brazos forjados cromo-vanadio, máxima resistencia
- Girando los brazos, el extractor puede ser utilizado como externo o interno
- Uñas diseñadas para permitir el acceso a lugares estrechos
- Tuercas en PVC para un ajuste rápido y sencillo

R		A	B	L	T <sub>h</sub>	g	
		mm	mm	mm			
701-90-1	N1	1	90	100	130	4	900
701-160-1	N2	1	160	150	210	6	2.450
701-250-1	N3	1	250	205	280	8	6.950

EXTRACTOR DOS GARRAS AUTOCENTRANTE



- Cuerpo y brazos de acero forjado
- Acabado galvanizado
- Ideal para extraer pequeñas partes como terminales de baterías, ruedas, rodamientos, etc.
- Los extremos de las garras se cierran automáticamente

R		A	B	T <sub>h</sub>	g
		mm	mm		
702-40-1	1	60	40	0.50	180
702-65-1	1	65	65	0.50	190
702-80-1	1	80	80	1.00	220

EXTRACTOR DE TRES GARRAS AUTOCENTRANTE



- Cuerpo y brazos de acero forjado
- Acabado galvanizado
- Ideal para extraer pequeñas partes como terminales de baterías, ruedas, rodamientos, etc.
- Los extremos de las garras se cierran automáticamente

R		A	B	T <sub>h</sub>	g
		mm	mm		
703-40-1	1	60	40	0.75	230
703-65-1	1	65	65	0.75	290
703-80-1	1	80	80	1.50	320

EXTRACTOR MÚLTIPLE

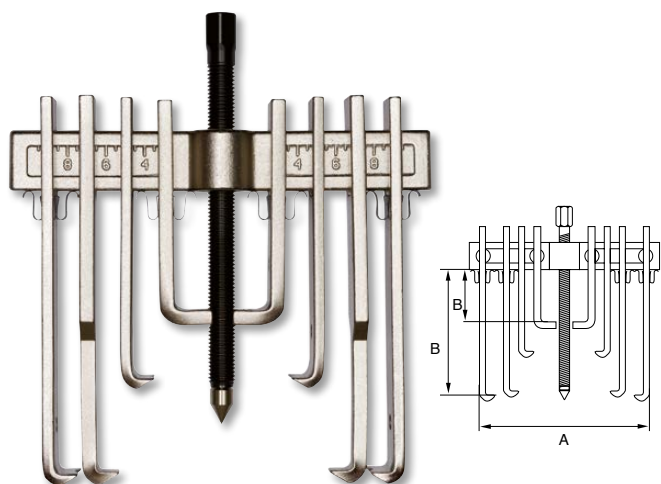

- Para ser utilizado como extractor interno o externo
- Se consigue gran longitud útil de trabajo atornillando entre sí las distintas garras

R	Icono	A (mm) min. - max.	B (mm) min. - max.	T <sub>tr</sub>	g
713001	1	20 - 173	65 - 140	5	2.700
713011	1	75 - 250	77 - 182	10	6.000

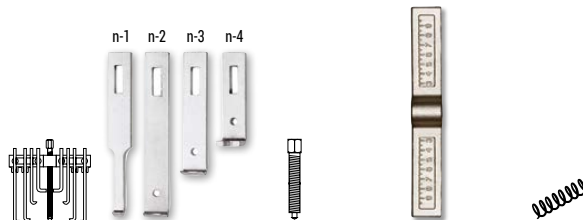

R	R	R	R	R
713001	796511 n-1	796491	796501	796551
	796521 n-2			
	796531 n-3			
	796541 n-4			
713011	713511 n-1	713611	796561	796571
	713521 n-2			
	713531 n-3			
	713541 n-4			

JUEGO DE PUNTAS EXTRACTORAS



- Juego completo de 15 extractores para cualquier tipo de espárragos o tornillos rotos
- El material NiCrMo confiere una alta calidad a las puntas
- Se suministra en una caja de plástico robusta y compacta

R	Icono	Icono	Icono	g
ZH1100	1	200 x 105 x 35		1.000

mm	mm
1/2" ZH1101 3	5/8" ZH1108 1/8"
ZH1102 4	ZH1109 3/16"
ZH1103 5	ZH1115 1/2"
ZH1104 5.5	ZH1110 1/4"
ZH1105 6	ZH1111 3/8"
ZH1106 8	ZH1112 11 mm
ZH1107 10	ZH1113 12 mm
	ZH1114 14 mm

EXTRACTORES DE ESPÁRRAGOS



- Para extraer tornillos y pernos rotos
- Acabado: granulado
- Acero al carbono de alta calidad

R	Icono	Icono	Icono	Icono	g
716-5-1	1	90 x 58 x 15	5	# 1, 2, 3, 4, 5 M3-M18	120
716-8-1	1	215 x 130 x 50	8	# 1, 2, 3, 4, 5, 6, 7, 8 M3-M50	840

#	mm	Ø mm	L mm	Icono	g
716-M6-1	1	2.0	4.00	M 3-6	4
716-M8-1	2	2.8	4.30	M 6-8	6
716-M11-1	3	4.0	6.00	M 8-11	13
716-M14-1	4	6.3	7.50	M 11-14	20
716-M18-1	5	7.5	10.70	M 14-18	45
	6	10.3	15.00	M 18-25	95
	7	13.5	19.00	M 25-35	140
	8	20.6	24.00	M 35-50	240



EXTRACTOR

PORTA MACHOS DE ROSCAR



- Con crique reversible: bloqueo de cambio de sentido
- Agarre paralelo
- Mordazas templadas
- Mango corredizo
- Acero cromado

Artículo	Cant.	Ø mm	L mm	Peso g
718211	1	2.6 - 5.5	85	180
718231	1	4.6 - 8	110	300

TRONZATUERCAS

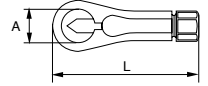

- Para separar tuercas atascadas o rayadas sin dañar la rosca del espárrago
- Acero especial galvanizado
- Cabezal de repuesto disponible

Artículo	Cant.	A mm	L mm	Ø mm	L mm	Peso g	Artículo	Artículo
730011	1	32	126	M3-M16	6-27	440	796661	796671
730131	1	42	170	M14-M24	24-40	560	796681	796691

EXTRACTOR MAGNÉTICO

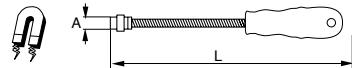

- Mango bicomponente con agujero para colgar y diseño antideslizante
- Varilla cromada pulida
- 720-1M-413: Imán neodimio extrafuerte capacidad 1 kg
- 720-3M-413: Imán neodimio extrafuerte capacidad 3 kg

Artículo	Cant.	Ø mm	A mm	L mm	L mm	L mm	Peso g
720-1M-413	1	10	10	550	413	110	130
720-3M-413	1	17	13	550	413	110	280

GANCHO EXTRACTOR CROMADO



- Para agarre de piezas muy pequeñas
- Eje flexible con el corazón de acero

Artículo	Cant.	L mm	Peso g
720031	1	650	80

EXTRACTOR DE GARRA MAGNÉTICO CON LUZ



- Para agarrar piezas muy pequeñas
- Luz incorporada para localizar objetos en la oscuridad
- Imán de neodimio en la punta
- Eje flexible con núcleo de acero
- Acabado Cromado

Artículo	Cant.	L mm	Peso g
720-LM-1	1	625	120

**PALANCA**

**PALANCA**

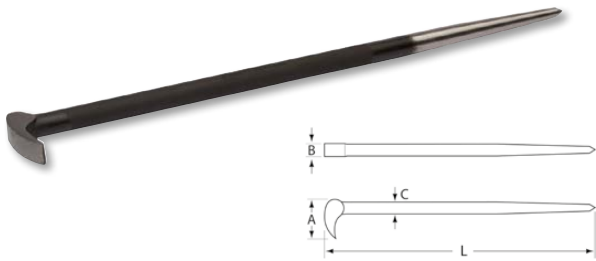

- Palanca polivalente 90° para trabajos en espacios confinados
- Acabado negro fosfatado con cabeza pulida y punta afilada
- Material: Aleación de acero especial endurecido

Q	Icono	A mm	B mm	C mm	L mm	g
066-400-1	1	44	14	14	406	450

**JUEGO DE 4 PALANCAS ACODADAS**



- Palancas con mangos de plástico muy ligeras
- Agarre cómodo para conseguir mayor potencia de elevación

Q	Icono	Dimensiones mm	g
ZH70610	1	645 x 115 x 35	1.400
ZH70611, ZH70612, ZH70613, ZH70614			

**PALANCA ACODADA**



- Palancas con mangos de plástico muy ligeras
- Agarre cómodo para conseguir mayor potencia de elevación

Q	Icono	L mm	g
ZH70611	1	210	200
ZH70612	1	310	300
ZH70613	1	460	400
ZH70614	1	610	500

1



2



3



4



5



6



7



8



9



10



11



12



## ARCOS TRONZADORES Y HOJAS

### ARCOS TRONZADORES



- Arco tronizador de acero con pintura en polvo
- 802-2400-1 para madera seca
- 802-3000-1 y 802-3600-1 para madera verde y mojada
- Protector incluido

R	Paquete	L mm	L"	T mm	g	oz
802-2400-1	5	607	24"	51	675	23.8
802-3000-1	5	759	30"	23	800	28.2
802-3600-1	5	912	36"	23	920	32.4

### HOJAS DE TRONZAR, MADERA VERDE



- Ideada para aserrar madera verde y húmeda
- Acero de alta calidad templado
- Envase individual con una protección de dentado para prevenir la oxidación

R	Paquete	L mm	L"	g	oz
802-2423-1	10	607	24"	60	2.1
802-3023-1	10	759	30"	75	2.6
802-3623-1	10	912	36"	95	3.4

### HOJAS DE TRONZAR, MADERA SECA



- Para aserrar madera seca
- Acero de alta calidad templado
- Envase individual con una protección de dentado para prevenir la oxidación

R	Paquete	L mm	L"	g	oz
802-2451-1	10	607	24"	65	2.3
802-3051-1	10	759	30"	80	2.8
802-3651-1	10	912	36"	100	3.5

## SERRUCHOS

### ARCO PARA METAL DE ALUMINIO

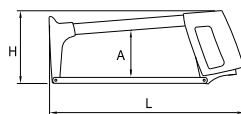
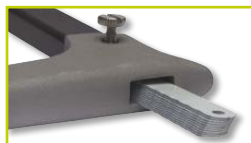

- Arco profesional muy robusto
- Suministrado con la hoja bimetálica de 24 DPP de 30 mm (12")
- Posibilidad de colocar la hoja en 55° para cortar a nivel

R	Paquete	L mm	T mm	g
801101	5	400 (300)	24	748

### ARCO DE METAL N.4

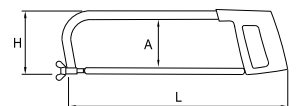

- Arco de sierra profesional y firme
- Ofrece un espacio de almacenaje de las hojas dentro de la parte negra rectangular
- Puede usarse como sierra compás
- Con opción de colocar la hoja a 55° para corte en inglete
- Se suministra con una hoja de sierra bimetálica de 24 DPP

R	Paquete	A mm	H mm	L mm	g
801-041-1	10	110	151	400	665

SERRUCHO UNIVERSAL



- Mango atornillado bicomponente
- Mango útil para hacer guías de 45 y 90°
- Para todo tipo de maderas

Modelo	Paquetes	mm	ft	DPP	g
800-168-1	10	400	16"	8	320
800-208-1	10	500	20"	8	360
800-228-1	10	550	22"	8	380

MINI ARCO DE ALUMINIO



- Un mini arco muy útil para cortar en lugares difíciles
- De muy fácil manejo
- Se suministra con una hoja de sierra de 24 DPP

Modelo	Paquetes	H mm	L mm	g
801-145-1	5	51	229	140

ARCO DE METAL N.1

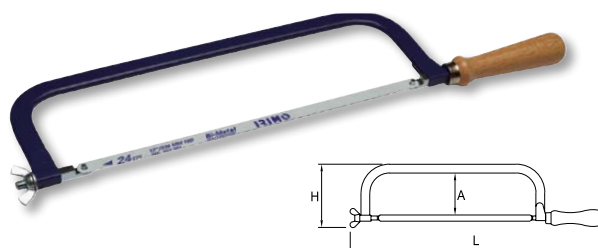

- Arco tradicional, de fácil uso

Modelo	Paquetes	A mm	H mm	L mm	g
801-011-1	10	100	128	512	575

CORONAS

JUEGO 6 CORONAS BI-METAL



- Juego:
  - 6 coronas bi-metales 22, 29, 35, 44, 51, 64 mm
  - Pequeño soporte
  - 1 broca de repuesto
- Estuche con foam bi-color

Modelo	Paquetes	Paquetes	mm	g
810-2264-4	1	9	230 x 180 x 70	1.000



LIMAS

PLANA PUNTA

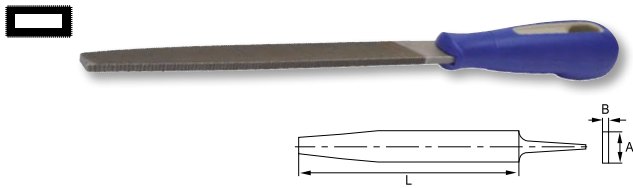

- Plana con punta
- Para limar superficies planas, esquinas, la forma de su punta facilita el acceso en ángulos y esquinas

		L mm	A mm	B mm			g
		BASTA					
534521	6	150 / 6"	16	4	13	33	90
534531	6	200 / 8"	20	5	10	25	160
534541	6	250 / 10"	25	5.5	9	23	250
534551	6	300 / 12"	30	6	8	20	413
		ENTREFINA					
534251	6	150 / 6"	16	4	18	46	50
534261	6	200 / 8"	20	5	14	36	160

MEDIA CAÑA

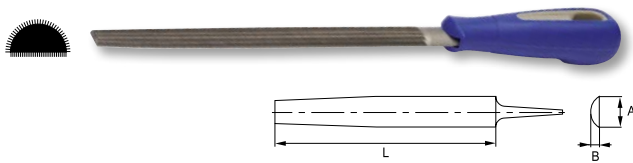

- Para limar superficies planas, cóncavas y grandes agujeros  
Ideal para desbaste

		L mm	A mm	B mm			g
		BASTA					
534681	6	150 / 6"	16	4.7	13	33	100
534691	6	200 / 8"	20.5	6	10	25	170
534701	6	250 / 10"	26.5	7.5	9	23	344
		ENTREFINA					
534371	6	150 / 6"	16	4.7	18	46	100
534381	6	200 / 8"	20.5	6	14	36	170

TRIANGULAR

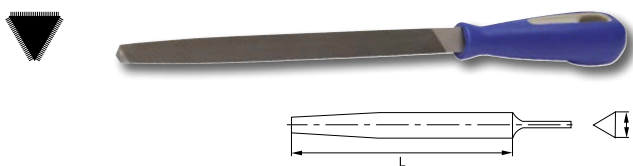

PLANA PARALELA

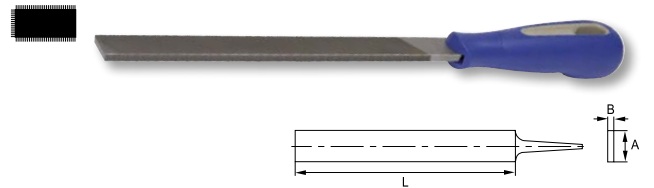

- Plana paralela basta
- Picado de doble superficie, un canto con picado simple, sin picado

		L mm	A mm	B mm			g
		BASTA					
534561	6	150 / 6"	16	4	13	33	90
534571	6	200 / 8"	20	5	10	25	160
		ENTREFINA					
534281	6	150 / 6"	16	4	18	46	50
534291	6	200 / 8"	20	5	14	36	160

REDONDA

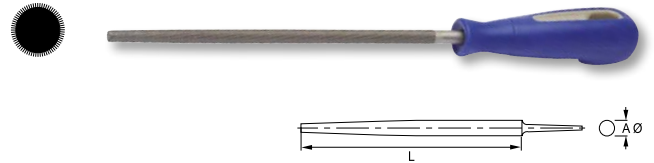

- Para limar agujeros, superficies cóncavas
- Picado de superficies doble

		L mm	A mm	B mm			g
		BASTA					
534601	6	150 / 6"	16	4.7	13	33	100
534611	6	200 / 8"	20.5	6	10	25	170
534621	6	250 / 10"	26.5	7.5	9	23	344
		ENTREFINA					
534311	6	150 / 6"	16	4.7	18	46	100
534321	6	200 / 8"	20.5	6	14	36	170

- Para afilado y desbaste en ángulos, esquinas interiores, superficies cóncavas y limados planos
- Picado de superficies doble

		L mm	A mm			g
		BASTA				
534901	6	150 / 6"	11	13	33	94
534911	6	200 / 8"	15.5	10	25	203
		ENTREFINA				
534341	6	150 / 6"	11	18	46	94
534351	6	200 / 8"	15.5	14	36	203

CUADRADA

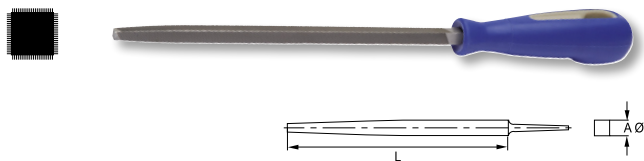

- Para limar ranuras, agujeros cuadrados y rectangulares, esquinas interiores y ajuste fino
- Picado de superficies doble

Q	Icono	L mm	A mm	Icono	Icono	g
534931	6	150 / 6"	6	13	33	79
534941	6	200 / 8"	8	10	25	132
534401	6	150 / 6"	6	18	46	79
534411	6	200 / 8"	8	14	36	132

JUEGO 6 LIMAS 8"



Q	Icono	Icono	Icono	g
534501	1	6	44 x 37 x 3	1.150
534261			534351	
534291			534381	
534321			534411	

NIVELES

NIVEL MAGNÉTICO CON TRES FRASCOS Y EMPUÑADURAS

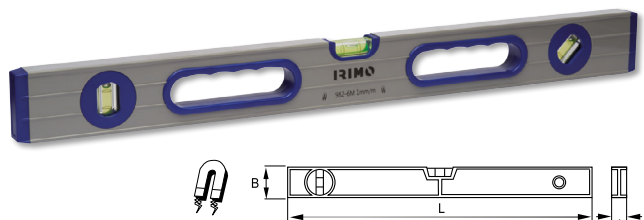

- Dos potentes imanes
- Necesarios 9 Newtons para separarlos entre sí
- Tres frascos tipo barril: Horizontal, vertical, 45°

Q	Icono	A mm	B mm	L mm	g
982-4M-1	1	22	60	400	280
982-6M-1	1	24	60	600	370

NIVEL CON TRES FRASCOS

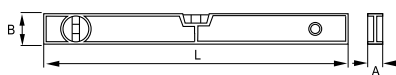

- Perfil de aluminio, ligero, 450 g/m
- Perfil ligero, fácil de transportar, tamaño 20 x 49 mm
- Precisión ±0,5 mm/m
- Frascos de gran visibilidad
- Tres frascos: horizontal, vertical y 45°
- Tapones protectores
- Pintura epoxy de larga duración

Q	Icono	A mm	B mm	L mm	g
981-800-1	1	20	49	800	275
981-1000-1	1	20	49	1.000	325
981-1200-1	1	20	49	1.200	380
981-1500-1	1	20	49	1.500	480
981-1800-1	1	20	49	1.800	550

NIVEL MAGNÉTICO CON TRES FRASCOS

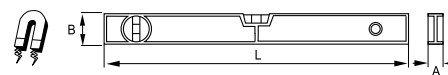
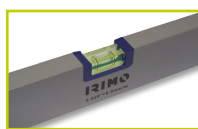

- Perfil de aluminio
- Perfil ligero, fácil de transportar, tamaño 22 x 49 mm
- Precisión ±0,5 mm/m
- Frascos de gran visibilidad
- Tres frascos: horizontal, vertical y 45°
- Incluye dos imanes
- Tapones protectores
- Pintura epoxy de larga duración

Q	Icono	A mm	B mm	L mm	g
981-400M-1	1	22	49	400	300



NIVELES

JUEGO DE NIVELES

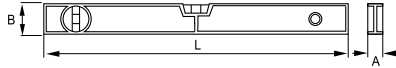

- Nivel tubular de 600 mm + torpedo 982-TOR
- Frascos de alta visibilidad y baja densidad
- Precisión:  $\pm 1$  mm/m

R	Icono	A mm	B mm	L mm	g
982-SET	1	55	60	600	410

NIVEL DE BOLSILLO 100 MM

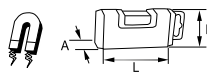
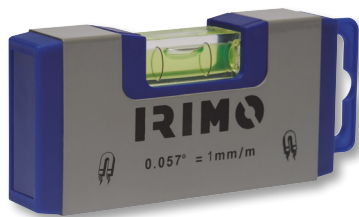

- Tamaño ideal para llevar en el bolsillo, 10 cm
- Precisión:  $\pm 1$  mm/m
- Frasco de alta visibilidad
- 2 fuertes imanes en la base que aguantan hasta 500 g

R	Icono	A mm	B mm	L mm	g
982-10-1	1	20	50	100	60

JUEGO NIVEL TORPEDO BASE MAGNÉTICA CON ESTUCHE



- Juego de nivel de aluminio con base magnética y estuche nylon para transporte fácil
- Precisión de  $\pm 1$  mm/m en todas las fiolas
- 3 frascos: horizontal, vertical y de  $45^\circ$
- Pareja de imanes fuertes de neodimio en la base

R	Icono	A mm	B mm	L mm	g
983-25-1	5	240 x 140 x 25			315

NIVEL "TORPEDO"



- Imán en la base
- Adecuado para fontaneros
- 3 frascos: horizontal, vertical y de  $45^\circ$
- Precisión de  $\pm 1$  mm/m en el frasco horizontal
- Precisión de  $\pm 1$  mm/m en los frascos verticales
- Líquido de alta visibilidad en el interior de los frascos

R	Icono	A mm	B mm	L mm	g
982-TOR-1	1	15	40	230	80

REGLA PLEGABLE DE MADERA

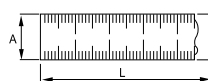

- Regla plegable con 10 hojas de madera
- Madera de abedul, flexible y resistente
- Barniz especial resistente a la abrasión
- Clase II de precisión acorde a la normativa UE de instrumentos de medición

R	Icono	A mm	L m	g
985-2-1	1	16	2	115

## GALGAS

### GALGAS DE ROSCAS



- Longitud de hoja: 70 mm

Q	Paquete	Paquete	Paquete	g
972-52-1	25	52 hojas		65
<b>Métrica 60° - 0,25 a 6 mm</b> 0,25-0,30-0,35-0,40-0,45-0,50-0,60-0,70-0,75- 0,80-0,90-1-1,25-1,50-1,75-2-2,5-3-3,5-4-4,5-5- 5,5-6 <b>Whitworth 55° - 4 a 62 hilos"</b> 4-4,5-5-6-7-8-9-10-11-12-13-14-16-18-19- 20-22-24-25-26-28-30-32-36-40- 48-60-62				

### GALGAS DE ESPESORES



- Longitud de hoja: 100 mm

Q	Paquete	Paquete	Paquete	g
971-13-1	5	13 hojas		52
<b>0,05 a 1 mm</b> 0,05-0,10-0,15-0,20-0,25-0,30-0,40-0,50-0,60-0,70- 0,80-0,90-1				
971-20-1	5	20 hojas		83
<b>0,05 a 1 mm</b> 0,05-0,10-0,15-0,20-0,25-0,30-0,35-0,40-0,45-0,50-0,55- 0,60-0,65-0,70-0,75-0,80-0,85-0,90-0,95-1				

## ESPÁTULAS

### ESPÁTULAS

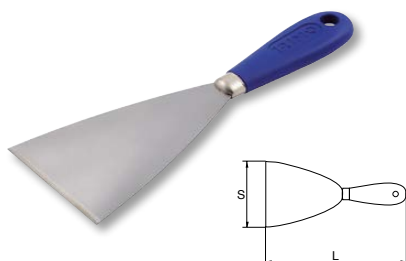

- Hoja templada de 1,5 mm de grosor / 0,5 mm en el filo
- Excelente flexibilidad
- Pulida y barnizada de larga durabilidad
- Virola metálica para la perfecta unión entre hoja y mango
- Mango de plástico con agujero para colgar
- DIN 7216, UNE 16608

Q	Paquete	S mm	L mm	g
540021	12	20	220	50
540031	12	30	220	55
540041	12	40	220	60
540051	12	50	220	65
540061	12	60	220	70
540071	12	70	220	75
540081	12	80	220	80
540091	12	90	220	85
540101	12	100	220	90
540121	12	120	220	100

### JUEGO DE ESPÁTULAS DE CARROCERO



- Juego de espátulas de carrocero, 4 piezas
- Cuchilla de acero al carbono
- Excelente flexibilidad y máxima durabilidad
- Cuchilla pulida y barnizada para evitar la oxidación
- Se suministra en una bolsa de plástico

Q	Paquete	Paquete	Paquete	g
536011	1	4	160x130	120
				90x50 mm, 120x80 mm, 120x105 mm, 120x120 mm

HERRAMIENTAS DE APRIETE

PISTOLA DE SILICONA

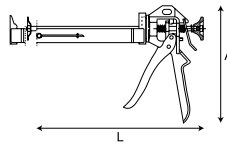

- Pistola de silicona para cartuchos de 9"
- Idónea para mayoría de resinas y siliconas
- Asa y gatillo fabricado en aluminio
- Cuerpo giratorio para facilitar la carga del cartucho
- Aguja incorporada
- Ratio de descarga 7:1
- Fuerza máxima de empuje 1500N

€		A mm	L mm	g
549-230-2	1	200	330	550

PISTOLA DE COLA TERMOFUSIBLE



- Con interruptor On-Off para ahorro de energía
- Normativa CE/GS
- Boquilla protectora para mayor durabilidad y seguridad
- Incluye dos boquillas adicionales y una válvula de seguridad para prevenir goteos involuntarios
- Gacho plegable para mantener la pistola en reposo
- Potencia de 80W; Voltaje 220-240V; Precalentamiento 3-5 minutos; Flujo de encolado 14-15 g por minuto. Cable de 1,6 m
- Contiene 12 barras de cola 11,2x150 mm (6 uso general, 6 cola extrafuerte)
- Embalaje en blíster

€			g
550-80-4	1	40x190x190	250



### **CASA CENTRAL | MAR DEL PLATA**

Av. Colon 5757 (CP 7600) | Tel: (223) 410.4000  
ccentral@iturria.com.ar

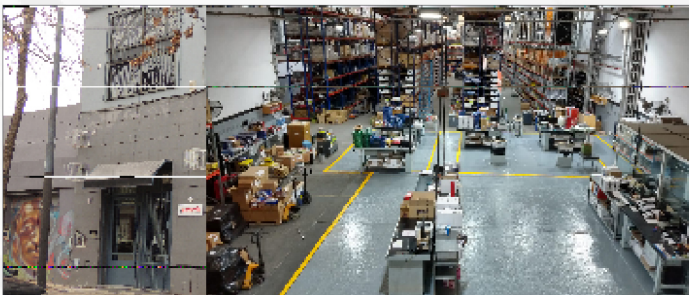

### **SUCURSAL CAPITAL FEDERAL**

Andonaegui 1035 (C1427BEC) | Tel: (011) 3526.3020  
sucursalcapital@iturria.com.ar



### **SUCURSAL BAHIA BLANCA**

Av. Colon 1477 (B8000FUE) | Tel: (0291) 455.0333  
sucursalbahia@iturria.com.ar

## **CATALOGO DIGITAL**

Con solo un click ahora puedes hacer todas tus compras desde **catalogodigital.iturria.com.ar**

