

# CATALOGO DE **BUJIAS INCANDESCENTES**

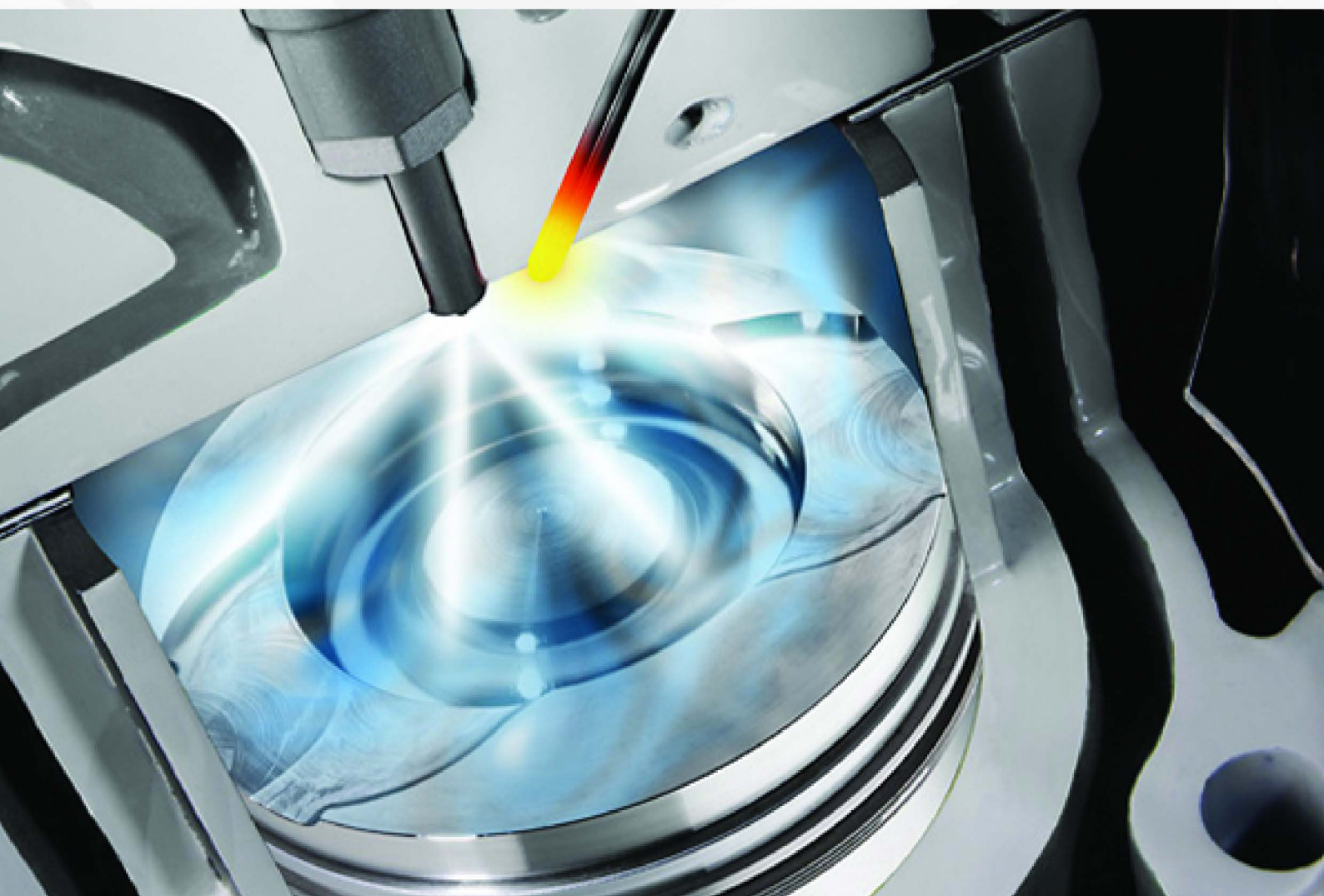

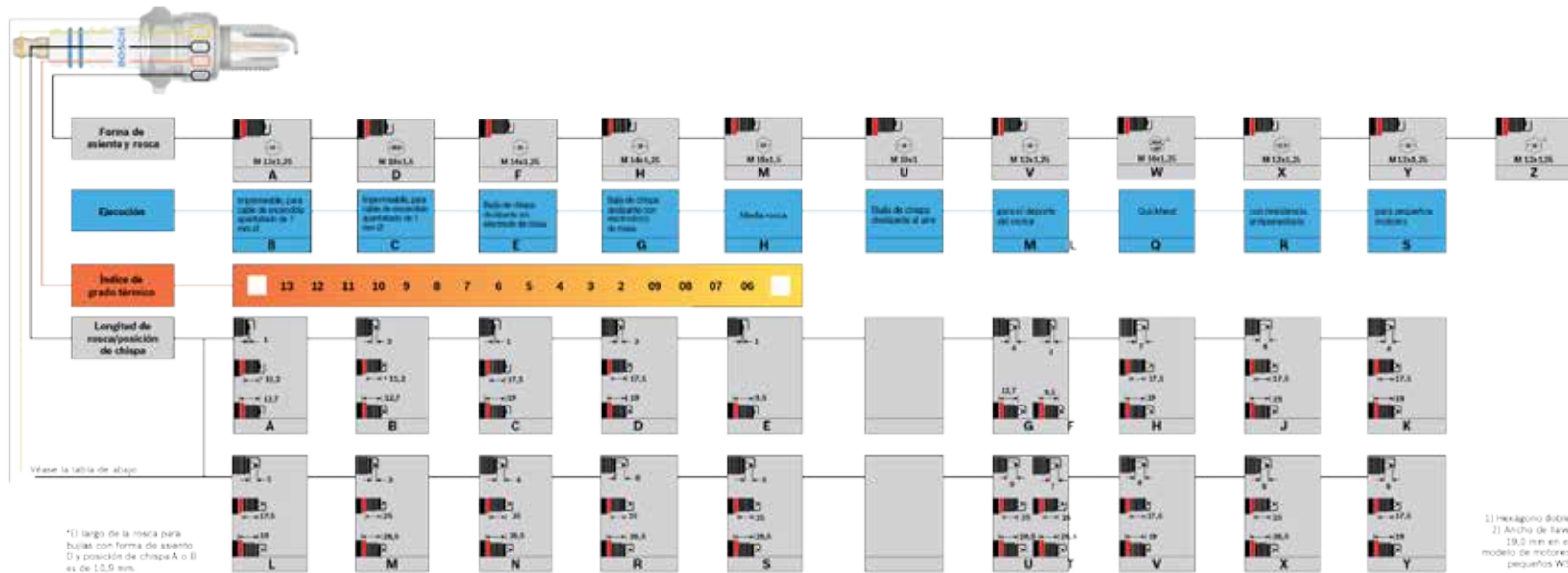

# Explicación de la fórmula de tipo



1) Hexágono doble  
2) Ancho de filete 13,0 mm en el modelo de motores pequeños WS

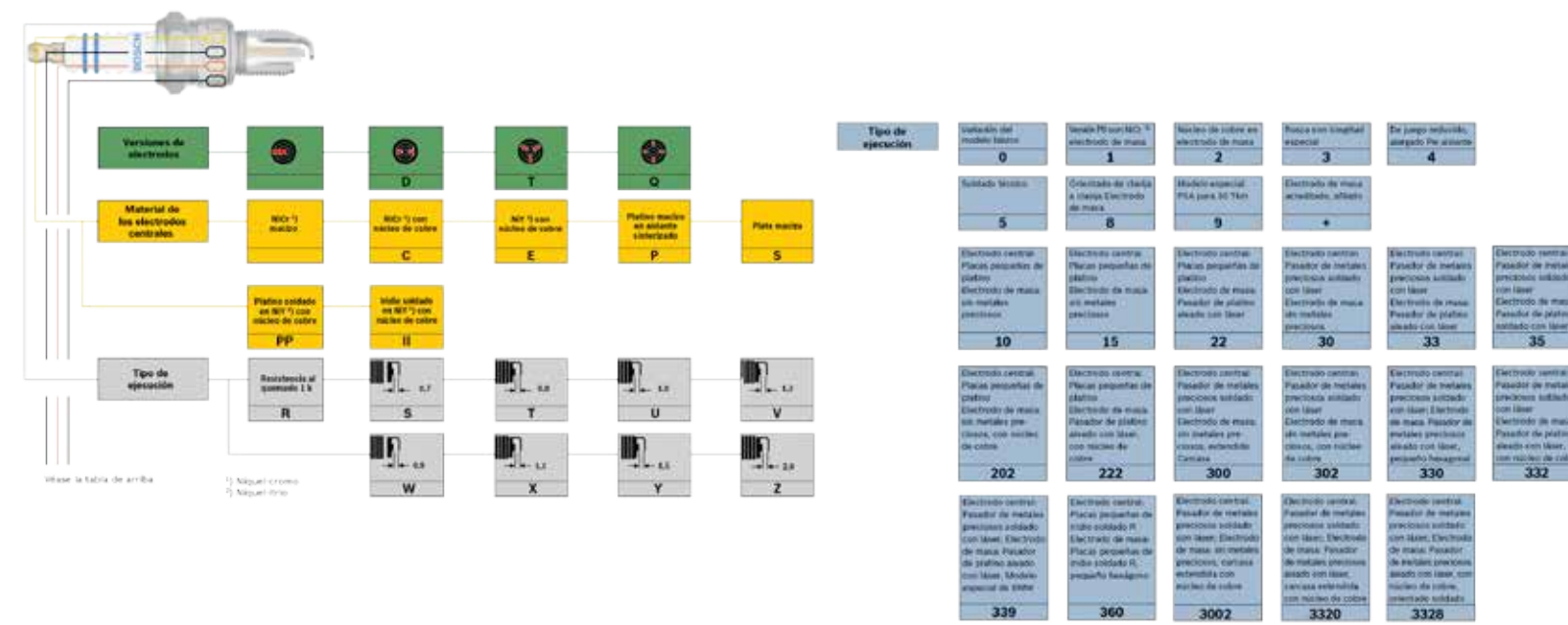



# ¿Cómo afecta la construcción de una bujía su desempeño?

## Función

Introducir la energía producida por el sistema de encendido en la cámara de combustión, generando una chispa eléctrica entre sus electrodos, para iniciar la combustión de la mezcla aire/combustible que mueve los pistones, haciendo que el motor funcione. La bujía de encendido es también responsable de absorber el calor generado en la cámara de combustión y disiparlo, permitiendo que el motor trabaje siempre en la temperatura adecuada a su potencia.

- 1) Aislador de Piranite.** La parte más importante de la bujía. Está hecha de óxido de aluminio y aditivos vítreos para soportar hasta 30,000 volts y una temperatura operante de hasta 840°C. La conductividad térmica del aislador en este rango de temperatura es crucial para determinar el grado térmico de la bujía y su desempeño para diferentes condiciones de manejo.
- 2) Tuerca de conexión.** Permite y sirve como conexión entre el cable de bujía y el perno de conexión transmitiendo adecuadamente el flujo de potencia.
- 3) Perno de conexión.** Es la unión con el electrodo central y va unido al aislador.
- 4) Barrera contra fuga de corriente.** Estas nervaduras de cerámica sirven más que para solo identificación de la bujía. Están diseñados para evitar la fuga de voltaje; su forma geométrica y el número de barreras quintuple se oponen a este fenómeno.
- 5) Carcasa de acero, niquelada.** El acero es el material más común para las carcasas. La carcasa y el aislador son unidos mediante un proceso de retractilado eléctrico. Algunos fabricantes usan laminado con zinc, pero las carcasas Bosch son laminadas con níquel para evitar la oxidación.
- 6) Resistor de supresión (Masa vítrea).** El aseguramiento en este punto previene que los gases calientes de combustión escapen y quiten potencia al motor. Esta masa es hecha a base de una mezcla vítreo-grafito-metalizada para mantener una conductividad constante y operar en todo tipo de temperatura, además de que filtran corrientes parásitas.
- 7) Arandela de sellado (Vedamiento).** Al tener buen contacto con la culata del motor actúa como un disipador de calor.
- 8) Rosca niquelada.** Por su manufactura permite un deslizamiento suave y nos evita el agarrotamiento o gripado, especialmente, en las culatas de aluminio, a diferencia de las laminadas con zinc.
- 9) Pie del aislador.** Expuesto a la cámara de combustión.
- 10) Núcleo de cobre en electrodo central.** Electrodo de tierra cuando se requiere.
- 11) Electrodo central.** Para encendido más rápido y una aceleración más cómoda.
- 12) Electrodo masa.** El electrodo central y electrodo masa dan el espacio y permiten la calibración de la bujía para la chispa. Debido a que el electrodo de masa es expuesto a altas temperaturas y voltaje, su material y tamaño son extremadamente importantes.



# Construcción/Componentes

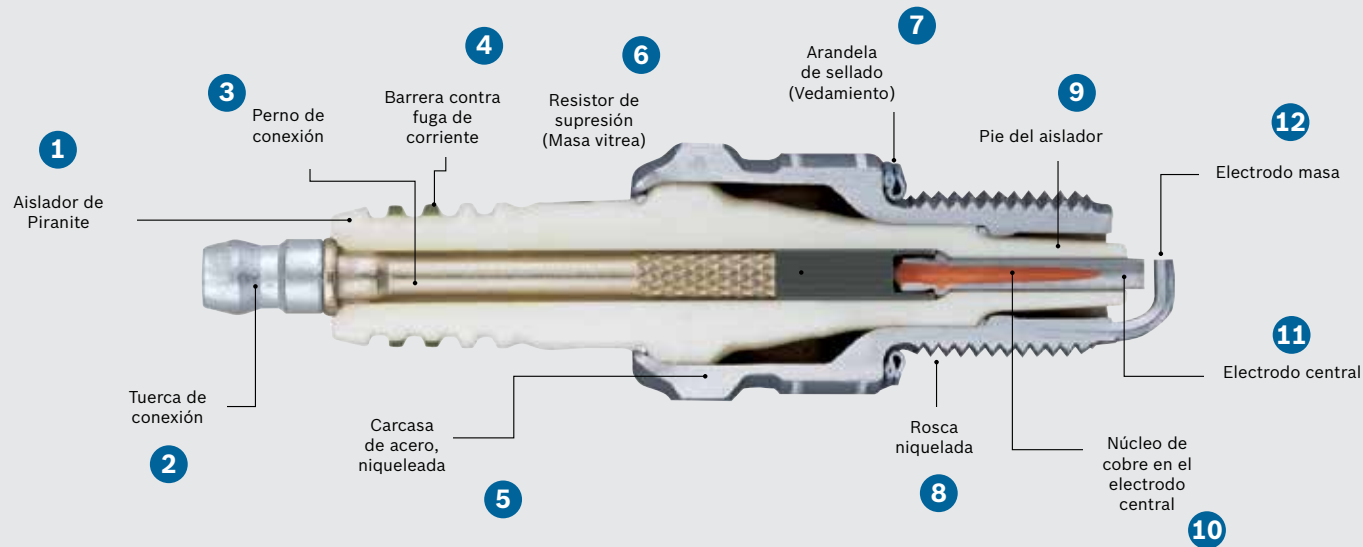

## Componentes

El formato y la aleación del material del electrodo central y del electrodo masa determinan el tipo de bujía.





# Grado Térmico

Los motores alcanzan temperaturas de trabajo distintas. Las bujías deben compensar esta variación para mantenerlos en temperatura adecuada a su necesidad. De esa manera ellas absorben y disipan el calor según la exigencia del motor. A esta capacidad damos el nombre de “grado térmico”. El tamaño y configuración del pie del aislador, además del material del electrodo, son las características que más influyen en la disipación del calor, que ocurre de la siguiente forma (ver abajo):

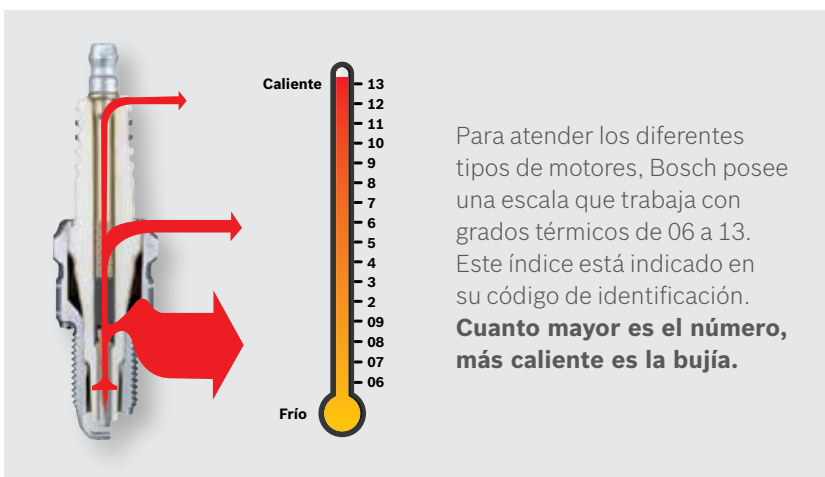

Para atender los diferentes tipos de motores, Bosch posee una escala que trabaja con grados térmicos de 06 a 13. Este índice está indicado en su código de identificación.  
**Cuanto mayor es el número, más caliente es la bujía.**

## Aplicaciones incorrectas



Bujía demasiado fría instalada en motor que exige bujía más caliente: fallas de encendido

Trabajando en baja temperatura, la bujía acumulará hollín en el pie del aislador, provocando fallas en el encendido e incluso impidiendo la formación de la chispa.



Bujía demasiado caliente instalada en motor que exige bujía más fría: encendido por incandescencia

La bujía puede sobrecalentarse y su contacto con la mezcla aire/combustible puede provocar el encendido por incandescencia, sobrecargando y dañando el motor.

Los motores más potentes y de mayor rendimiento trabajan con temperaturas muy altas y, por lo tanto, necesitan una bujía que disipe el calor de la cámara de combustión más rápidamente. **Bujía fría → grado térmico bajo.**

En cambio, los vehículos más tradicionales operan con temperaturas más bajas, por lo que requieren una bujía que haga la disipación de calor más lentamente. **Bujía caliente → grado térmico alto.**



# Técnica de la chispa de bujías de encendido

**Electrodo de cubierta – electrodo central.**



**Electrodo lateral – electrodo central.**



**Electrodo de masa perfilado – electrodo central.**



**Electrodo lateral – superficie de aislador – electrodo central.**



**Electrodo lateral – electrodo central o electrodo lateral – superficie de aislador – electrodo central.**



## Bujías de encendido con técnica de chispa al aire

La chispa de encendido salta directamente del electrodo central al de masa, atravesando la mezcla de aire y combustible que se encuentra entre ambos electrodos (fig. a, b, c).

### Las ventajas:

- Gran seguridad de encendido durante toda la vida útil.
- Buen comportamiento de arranque en frío.
- Escasa demanda de tensión de encendido.

Los cantos vivos adicionales interiores que se forman con el perfil del electrodo de masa proporcionan, en combinación con el espacio ampliado entre los electrodos, una transmisión más sencilla y aún más efectiva de la energía térmica de la chispa a la mezcla de aire y combustible (fig. c).

### Las ventajas:

- Gran seguridad de encendido por la rapidez con que salta la chispa y se inflama la mezcla.

- Seguridad adicional en el arranque en frío, también con una tensión de abordo baja.
- Mejor combustión, lo que protege el motor y, especialmente, el catalizador.
- Reducción adicional del consumo de combustible al evitar fallos de encendido.

## Bujías de encendido con técnica de chispa deslizante

Los electrodos de masa están instalados por construcción de modo que puedan formarse exclusivamente chispas deslizantes al aire particularmente largas y potentes (fig. d).

### Las ventajas:

- Mayor seguridad de encendido durante toda la vida útil.
- Protección óptima del catalizador.
- Demanda de tensión de encendido particularmente baja.
- Efecto de autolimpieza en caso de formación de hollín.
- Mayor vida útil por disposición de varios electrodos de masa.

## Bujías de encendido con técnica de chispa deslizante al aire

La chispa de encendido elige la mejor vía para el encendido seguro desde el electrodo central hasta el electrodo de masa, ya sea como chispa al aire o como chispa deslizante al aire. En el encendido, la chispa al aire salta directamente del electrodo central al electrodo de masa. La chispa se desliza sobre portadores de carga presentes en la punta del pie del aislador y salta en forma de chispa al aire hacia el electrodo de masa (fig. e).

### Las ventajas:

- Mayor seguridad de encendido durante toda la vida útil.
- Mejor comportamiento de arranque en frío.
- Escasa demanda de tensión de encendido.
- Efecto de autolimpieza en caso de formación de hollín.
- Protección óptima del catalizador.
- La disposición de varios electrodos de masa incrementa la vida útil.



# Bujía Bosch Doble Iridio

Diseñada para proveer el más alto rendimiento y larga vida

Las bujías Bosch Iridio están diseñadas para ofrecer el más alto rendimiento y larga duración. El diseño de equipo original de Bosch, los materiales y los procesos de fabricación representan **lo mejor de la tecnología Bosch** en el mercado.

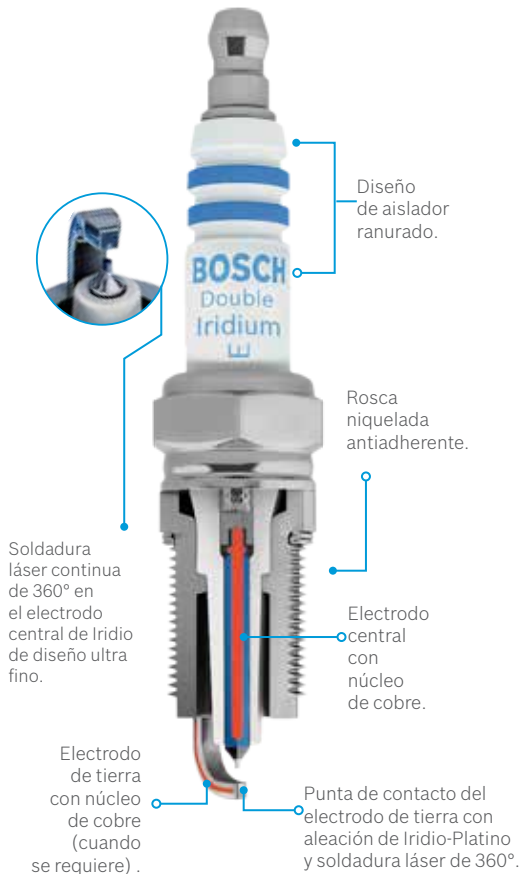

## Tecnología de punta fina

El diseño de punta fina y el electrodo de masa cónico con soldadura láser de 360° ofrecen el más alto rendimiento, mientras que el electrodo central de iridio, también con soldadura láser de 360°, provee hasta 4 veces mayor duración que las bujías estándar de cobre.

## Lo mejor de la tecnología de Equipo Original

Usted no tiene que escoger entre alto desempeño y larga duración en su bujía de Iridio. Bosch Iridio está diseñada para darle ambas. El diseño de equipo original Bosch, materiales y procesos, representan lo mejor de la tecnología. Mientras que el diseño de electrodo central ultra fino y electrodo de masa apuntado soldados con láser entregan el máximo desempeño, el electrodo central de iridio y el electrodo de masa con aleación de platino ayudan a ir más lejos. Libere el potencial de su motor con bujías Bosch Iridio.

Característica	Beneficio
<b>Electrodo Central:</b> <ul style="list-style-type: none"> <li>Soldadura láser continua de 360° para fusionar la punta de Iridio</li> <li>Diseño ultra fino</li> <li>Núcleo de cobre</li> </ul>	<ul style="list-style-type: none"> <li>Mejora la durabilidad</li> <li>Entrega un desempeño e ignición excepcionales</li> <li>Incrementa el rango de calentamiento para resistir pre-igniciones</li> </ul>
<b>Electrodo de masa:</b> <ul style="list-style-type: none"> <li>Forma apuntada</li> <li>Soldadura láser en la punta de Iridio con aleación de Platino</li> <li>Núcleo de cobre (cuando es requerido)</li> </ul>	<ul style="list-style-type: none"> <li>Mejora la combustión y potencia</li> <li>Mejora la durabilidad</li> <li>Incrementa el rango de calentamiento para resistir pre-igniciones</li> </ul>
Rosca niquelada antiadherente	Protección contra la corrosión y la adherencia
Aislador con diseño ranurado	Prevé contra falta de ignición
Garantía de desempeño por 7 años	Le da kilómetros de tranquilidad al manejar



# Bujía Bosch Doble Platino

Diseñada para un alto rendimiento y larga vida

Las bujías Bosch Doble Platino fueron creadas para incrementar el desempeño y vida útil. El diseño de punta fina en el electrodo central mejora la ignición y desempeño en su motor, mientras que la punta de platino en el electrodo central y de tierra aseguran una larga duración.

## Tecnología de punta fina

Las bujías de doble platino Bosch están diseñadas para una vida útil y durabilidad prolongadas. El diseño de punta fina del electrodo central mejora la ignición y el rendimiento de su motor, mientras la punta de platino del electrodo central y de tierra garantizan una mayor vida útil, logrando hasta 3 veces mayor durabilidad que las bujías estándar de cobre.

## Tecnología de punta fina

Las bujías Bosch Doble Platino están diseñadas para incrementar el desempeño y la vida útil. El diseño de punta fina en el electrodo central mejora la ignición y desempeño en su motor, mientras que la punta de platino en el electrodo central y de masa aseguran una larga duración.



Característica	Beneficio
<b>Electrodo Central:</b>	
<ul style="list-style-type: none"> <li>Soldadura láser continua de 360° para fusionar la punta de platino</li> <li>Diseño ultra fino</li> <li>Núcleo de cobre</li> </ul>	<ul style="list-style-type: none"> <li>Mejora la durabilidad</li> <li>Entrega un desempeño e ignición excepcionales</li> <li>Incrementa el rango de calentamiento para resistir pre-igniciones</li> </ul>
<b>Electrodo de masa:</b>	
<ul style="list-style-type: none"> <li>Soldadura láser en la punta de Platino</li> <li>Núcleo de cobre (cuando se requiere)</li> </ul>	<ul style="list-style-type: none"> <li>Mejora la durabilidad</li> <li>Incrementa el rango de calentamiento para resistir pre-igniciones</li> </ul>
Rosca níquelada antiadherente	Protección contra la corrosión y la adherencia
Aislador con diseño ranurado	Prevé contra falta de ignición
Pre-calibrada	No necesita calibrarse para una rápida instalación





# Bujía Bosch Platino

Diseñada para proporcionar un arranque y rendimiento mejorados

El diseño de equipo original, la tecnología de punta fina y soldadura láser de 360° ofrece un ajuste y funcionamiento ideales para una vida útil 2 veces mayor, en comparación con las bujías estándar de cobre.

Compare las características del producto y verá que Bosch Platino es la mejor opción para su vehículo.

### Tecnología de punta fina

Las bujías Bosch Platino están diseñadas para ofrecer un mejor arranque y desempeño en su motor.

### Tecnología OE Fine Wire

La tecnología OE Fine Wire entrega un diseño ideal y dos veces más de vida de servicio comparada con bujías de cobre convencionales. Con Bujías Bosch Platino su satisfacción y desempeño excepcional están garantizados.

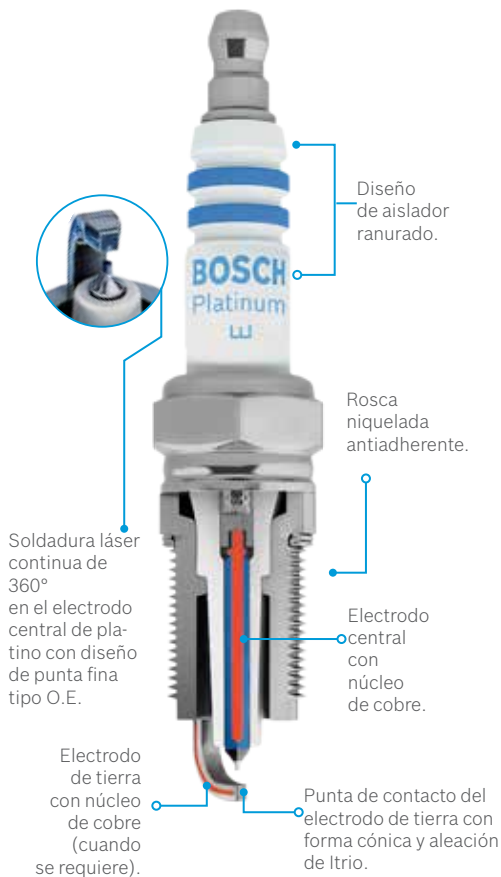

Característica	Beneficio
<b>Electrodo Central:</b>	
• Soldadura láser continua de 360° para fusionar la punta de platino	• Mejora la durabilidad
• Diseño ultra fino	• Entrega un desempeño e ignición excepcionales
• Núcleo de cobre	• Incrementa el rango de calentamiento para resistir pre-igniciones
<b>Electrodo de masa:</b>	
• Forma cónica	• Mejora la combustión
• Itrio mejorado	• Mayor resistencia al desgaste
• Núcleo de cobre (cuando es requerido)	• Incrementa el rango de calentamiento para resistir pre-igniciones
Rosca niquelada antiadherente	Protección contra la corrosión y la adherencia
Aislador con diseño ranurado	Prevé contra falta de ignición
Garantía de desempeño por 4 años	Le da kilómetros de tranquilidad al manejar



# Bujía Bosch Super 4

Innovadora técnica inteligente incluso para modelos antiguos

## Bosch Super 4

Ofrece 4 electrodos de masa finos, con electrodo central con núcleo de cobre cubierto de plata y en forma de punta de flecha brindando 8 posibles recorridos diferentes de chispa pre-calibrados para su instalación más sencilla.

Ventajas técnicas:

### 1.-Chispa al aire

La chispa enciende la mezcla aire/combustible en el recorrido directo entre el electrodo central y el electrodo de masa.

### 2.-Chispa deslizante

En la chispa deslizante, ésta se desplaza a través del aislador entre el electrodo central y de masa, buscando siempre el recorrido más corto. Es decir, la distancia entre los electrodos aumenta demasiado por el desgaste natural, de manera que el recorrido a través del aislador es más corto, transformándose de bujía de chispa al aire a una de chispa deslizante. Su principal ventaja consiste en quemar las partículas de hollín depositadas en el pie del aislador (como residuos de la combustión) reduciendo así el peligro de derivaciones eléctricas.

#### Característica

- Mayor energía a la mezcla
- Rendimiento de la bujía superior al 60%
- Tres veces mejor arranque en frío que las normales
- Mayor seguridad de encendido
- Mayor aceleración y elasticidad del motor

#### Beneficio

- Mayor aceleración y suavidad de marcha
- Mejor aprovechamiento del combustible y eficiencia del motor
- Más seguridad al alcanzar en 0.4 seg 12 km/h en una distancia de 13.3 metros. En carretera esta puede ser una diferencia determinante en el rebase de automóviles y en pendientes
- Programa reducido único, con alta cobertura de mercado, al ser termo elásticas con aplicaciones a mayor número de automóviles, es decir, 1 tipo puede cubrir 2 grados térmicos
- Manipulación simple, almacenamiento más sencillo y alto índice de rotación





# Bujía Bosch Super & Super Plus [Níquel]

Rendimiento óptimo en las condiciones de funcionamiento más adversas

## Bosch Super

Las Bujías Bosch Super tienen un electrodo central compuesto con núcleo de cobre, supresor de interferencias y electrodo de masa superdimensionado. Se clasifican en: BOSCH SUPER DTC de tres electrodos de masa, electrodo central de níquel-cromo con núcleo de cobre y BOSCH SUPER LDC posición de chispa perfectamente dimensionado, 2 electrodos de masa, longitud de rosca de 19 mm, con electrodo central de níquel-cromo con núcleo de cobre.

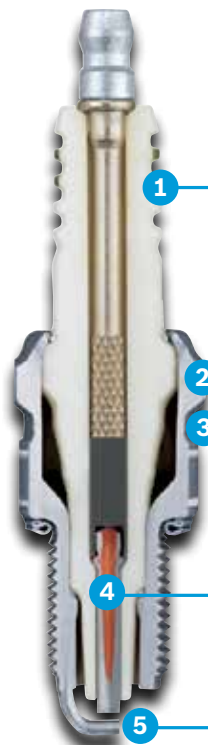

**(1) Barrera quintuple contra corriente de fuga.**

Impiden los picos de tensión y con ello las fallas de encendido.

**(2) Cuerpo de bujía y rosca níquelada.** Para la protección contra la corrosión, la oxidación y el agarrotamiento de la rosca en la culata de aluminio.

**(3) Montaje de contracción en caliente.** Garantiza la estanqueidad de los gases y un grado térmico exacto.

**(4) Electrodo central.** Compuesto de un núcleo de cobre como conductor térmico recubierto de níquel-cromo. Acelera la disipación del calor, impide fallos de encendido y proporciona mayor intervalo térmico de trabajo. La parte que penetra en la cámara de combustión está configurada de acuerdo al tipo de chispa que se produce y a la ejecución de los electrodos de masa.

**(5) Electrodo de masa.** La disposición, su número y su geometría influyen en la técnica de la bujía de encendido y con ello su vida útil.



## Bosch Super Plus

El electrodo central con una aleación de itrio y su electrodo de masa perfilado en forma de punta, permite un encendido seguro, ya que está sometido a un menor desgaste que el electrodo central. Estas ventajas se pueden aprovechar así durante toda la vida útil de la bujía de encendido teniendo como beneficio:

- Mayor seguridad de encendido al producirse con mayor rapidez el salto de la chispa
- de encendido y la inflamación de la mezcla
- Seguridad adicional en el arranque en frío, también con un bajo voltaje para el encendido
- Mejor combustión, con mejor protección del motor y especialmente del catalizador
- Gran reducción de consumo de combustible al evitar fallos de encendido

### Ventajas técnicas

- En comparación con los electrodos centrales estándar, se alcanza una mejor conductividad térmica, con tolerancia superior a la corrosión y alta resistencia al desgaste.

### Beneficios

- Aprovechamiento total del combustible desde el arranque, además de soportar correctamente los altos voltajes y sobrecargas.



# Análisis del estado de las bujías de encendido

## 1 + 2 Normal

Pie del aislador de color blanco o amarillo grisáceo hasta pardo corzo. El motor está a punto. Se ha elegido el grado térmico correcto. El ajuste de la mezcla y del encendido son perfectos, no hay fallos de encendido, el sistema de arranque en frío funciona. No hay residuos de aditivos del combustible que contengan plomo ni de componentes de aleación del aceite del motor. No existe sobrecarga térmica.

## 3 + 4 Bujía cubierta de hollín

Pie del aislador, electrodos y cuerpo de la bujía cubiertos de hollín de color negro mate y aspecto aterciopelado.

**Causa:** ajuste incorrecto de la mezcla (carburador, inyección): mezcla demasiado rica, filtro del aire muy sucio, dispositivo automático de arranque defectuoso o el cable de mando del estrangulador se ha estirado demasiado, recorridos predominantemente cortos, bujía demasiado fría, índice del grado térmico demasiado bajo.

**Repercusiones:** fallos del encendido, mal comportamiento de arranque en frío.

**Remedio:** ajustar correctamente la mezcla y el dispositivo de arranque, revisar el filtro del aire.

## 5 + 6 Bujía engrasada

Pie del aislador, electrodos y cuerpo de la bujía cubiertos de hollín aceitoso brillante o de carbonilla.

**Causa:** demasiado aceite en la cámara de combustión. Excesivo nivel de aceite, segmentos de pistón, cilindros y guías de válvulas muy desgastados. En motores de gasolina de dos tiempos, demasiado aceite en la mezcla.

**Repercusiones:** fallos del encendido, mal comportamiento de arranque.

**Remedio:** revisar el motor, emplear una mezcla correcta de combustible y aceite, montar nuevas bujías de encendido.

## 7 Ferroceno

Pie del aislador, electrodos y en parte cuerpo de la bujía cubiertos de sedimentos rojos-naranja firmemente adheridos.

**Causa:** aditivos del combustible con contenido de hierro. Los sedimentos se forman durante el funcionamiento normal después de unos pocos miles de kilómetros.

**Repercusiones:** la capa con contenido de hierro es eléctricamente conductiva y provoca fallos del encendido.

**Remedio:** montar bujías de encendido nuevas; limpiarlas resulta inútil.

## 8 Depósitos de plomo

El pie del aislador presenta en algunos puntos una vitrificación pardo-amarillenta, que puede adoptar una coloración verdosa.

**Causa:** aditivos con plomo en el combustible. La vitrificación se forma al someter el motor a una carga elevada después de haber funcionado largo tiempo a carga parcial.

**Repercusiones:** con cargas elevadas, la capa se torna electro-conductora y causa fallos del encendido.

**Remedio:** montar bujías de encendido nuevas; limpiarlas resulta inútil.

## 9 + 10 Grandes depósitos de plomo

El pie del aislador presenta en algunos puntos una gruesa vitrificación pardo-amarillenta, que puede adoptar una coloración verdosa.





# Análisis del estado de las bujías de encendido

**Causa:** aditivos con plomo en el combustible. La vitrificación se forma al someter el motor a una carga elevada después de haber funcionado largo tiempo a carga parcial.

**Repercusiones:** con cargas elevadas, la capa se torna electroconductora y causa fallos del encendido.

**Remedio:** montar bujías de encendido nuevas; limpiarlas resulta inútil.

## 11 + 12 Formación de ceniza

Gruesa capa de ceniza proveniente de aditivos del aceite y del combustible, depositada sobre el pie del aislador, en el espacio de ventilación (rendija anular) y sobre el electrodo de masa. Estructura entre suelta y semejante a la escoria.

**Causa:** componentes de aleación, procedentes especialmente del aceite, pueden depositar esta ceniza en la cámara de combustión y sobre la cara de la bujía.

**Repercusiones:** puede causar autoencendido con pérdida de potencia e incluso daños en el motor.

**Remedio:** poner el motor a punto. Montar bujías nuevas, emplear eventualmente otro aceite.

## 13 Electrodo central parcialmente fundido

Electrodo central parcialmente fundido, punta del pie del aislador cubierta de burbujas, esponjosa y reblandecida.

**Causa:** sobrecarga térmica debida, por ejemplo, a un ajuste demasiado avanzado del punto de encendido, residuos de combustión en la cámara de combustión, válvulas defectuosas, distribuidor de encendido deteriorado y combustible de calidad insuficiente.

**Repercusiones:** fallos del encendido, pérdida de potencia (daños en el motor).

**Remedio:** revisar el motor, el encendido y la preparación de la mezcla. montar bujías nuevas con el grado térmico correcto.

## 14 Electrodo central completamente fundido

Electrodo central completamente fundido; al mismo tiempo, electrodo de masa muy deteriorado.

**Causa:** sobrecarga térmica debida, por ejemplo, a un ajuste demasiado avanzado del punto de encendido, residuos de combustión en la cámara de combustión, válvulas defectuosas, distribuidor de encendido deteriorado y combustible de calidad insuficiente.

**Repercusiones:** fallos de encendido, pérdida de potencia, eventuales daños en el motor. Se puede agrietar el pie del aislador debido a sobrecalentamiento del electrodo central.

**Remedio:** revisar el motor, el encendido y la preparación de la mezcla. Montar nuevas bujías de encendido.

## 15 Electrodo central parcialmente fundido

Electrodos con aspecto de coliflor. Posible precipitación de sustancias ajenas a la bujía.





# Análisis del estado de las bujías de encendido

**Causa:** sobrecarga térmica debida, por ejemplo, a un ajuste demasiado avanzado del punto de encendido, residuos de combustión en la cámara de combustión, válvulas defectuosas, distribuidor de encendido deteriorado y calidad insuficiente del combustible.

**Repercusiones:** antes del fallo total (daños en el motor), se produce pérdida de potencia.

**Remedio:** revisar el motor, el encendido y la preparación de la mezcla. Montar nuevas bujías de encendido.

## 16 Fuerte desgaste del electrodo central

**Causa:** las bujías de encendido no se han cambiado en el intervalo previsto.

**Repercusiones:** fallos de encendido, especialmente al acelerar (la tensión de encendido ya no es suficiente para compensar la gran separación de los electrodos). Mal comportamiento de arranque.

**Remedio:** montar nuevas bujías de encendido.

## 17 Fuerte desgaste del electrodo de masa

**Causa:** aditivos agresivos del combustible y del aceite. Condiciones de flujo desfavorables en la cámara de combustión, debidas eventualmente a depósitos, picado del motor. No existe sobrecarga térmica.

**Repercusiones:** fallos de encendido, especialmente al acelerar (la tensión de encendido ya no es suficiente para compensar la gran separación de los electrodos). Mal comportamiento de arranque.

**Remedio:** montar nuevas bujías de encendido.

## 18 Rotura del pie del aislador

**Causa:** daños de origen mecánico debidos a golpe, caída o presión sobre el electrodo central por manipulación inadecuada. En casos extremos, debido a depósitos entre el electrodo central y el pie del aislador y a corrosión del electrodo central se puede romper el pie del aislador, especialmente en caso de funcionamiento demasiado prolongado.

**Repercusiones:** fallos del encendido, la chispa de encendido salta en puntos a los que la mezcla.





# Dudas más frecuentes

## 1. ¿Cuánto tiempo dura una bujía? ¿Cuándo debe ser hecho su cambio?

**R:** La vida útil de una bujía depende de sus características, o sea, tipo de material y cantidad de electrodos, además del tipo de combustible utilizado por el vehículo.

Lo correcto es seguir la recomendación del fabricante del vehículo, especificada en el manual del propietario.

## 2. ¿Cuál es la bujía correcta para el vehículo?

**R:** Para identificar la bujía correcta, es necesario consultar el catálogo de aplicación de bujías de Bosch o el manual del propietario del vehículo.

## 3. La bujía posee una parte de cerámica. ¿Esta parte es frágil? ¿Puede romperse e influir en el funcionamiento de la bujía?

**R:** El aislador (cerámica) es extremadamente resistente a elevadas temperaturas, gases de la combustión, choque térmico y alta tensión. Es muy raro que ocurra, pero cuando ocurre la

rajadura es generalmente en función de la utilización de herramienta inadecuada en la instalación de la bujía en el motor del vehículo o cuando sufre caídas o golpes.

## 4. Cuando el motor del vehículo falla, ¿normalmente es por culpa de las bujías?

**R:** No, en general eso ocurre cuando el motor tiene deficiencias en los sistemas de encendido y alimentación de combustible y por lo tanto la combustión no se realiza como el motor necesita (combustión incompleta), lo que se nota en el funcionamiento de las bujías de encendido.

## 5. ¿Al instalar una bujía nueva se debe lubricar la rosca?

**R:** No, pues la rosca es niquelada justamente para evitar que se agarre a la culata; además ella viene lubricada con un aceite especial de la fábrica. Si le ponen una grasa cualquiera, con la variación de la temperatura del motor, la grasa puede derretirse y la bujía agarra a la culata, dificultando su retirada.

## 6. ¿La bujía se debe calibrar antes de ser instalada en el motor?

**R:** La bujía ya viene pre ajustada de fábrica, pero puede ocurrir que cuando el mecánico vaya a instalarla, ésta se le escape de las manos y se vaya al suelo, cerrando la separación entre electrodos. Por lo tanto, siempre se recomienda averiguar la distancia antes de instalar.



## Identificando problemas

El funcionamiento de las bujías puede ser perjudicado por varios factores externos:

- Utilización de bujía inadecuada al modelo del vehículo.
- Mala regulación del sistema de encendido.
- Mala instalación, llave inadecuada.
- Ajuste de la distancia de los electrodos hecho de manera inadecuada.
- Cables de encendido dañados.
- Combustible inadecuado.
- Motor quemando aceite.
- Filtro de aire sucio.

Por eso, es siempre importante verificar la existencia de problemas que pueden estar influyendo en el desempeño de las bujías, así como ponerse en contacto con el equipo técnico profesional Bosch.



# Montaje de las Bujías

	Asiento plano		Asiento cónico	
	①	②	①	②
M 10 x1	10...15	10...15		
M 12 x1,25	15...25	15...20		
M 14 x1,25 l < 12,7 mm	20...25	15...20		
M 14 x1,25 l > 12,7 mm	20...40	20...30		
M 18 x1,5	30...45	20...35		

## Montaje correcto de la bujía con llave dinamométrica:

Par de apriete (N • m): 10 N • m ≈ 1 kpm

### Observar:

Los pares de apriete mencionados son válidos para roscas secas, no lubricadas con grasa ni aceite y para anillos obturadores nuevos.

En el caso de roscas lubricadas o si se vuelve a montar una bujía, los pares de apriete indicados deben reducirse en 1/3.

1. En hierro colado
1. En aleación ligera

## Montaje correcto de la bujía de encendido sin llave dinamométrica:

### Observar:

Enroscar con la mano la bujía de encendido hasta que haga tope en la culata.

Las bujías de encendido con asiento plano y una nueva junta se giran aproximadamente 90 grados más con la llave de bujías. Las bujías de encendido con asiento cónico y anillo obturador plano continúan girándose aprox. 15 grados más.

## Tuercas de conexión de bujías de encendido

### Observar:

En el motor pueden estar montadas bujías que en su longitud difieran de las bujías de encendido Bosch.

1. Desenroscar las bujías de encendido viejas.
2. Compararlas con bujías de encendido Bosch nuevas.
3. Si la bujía de encendido a sustituir es más larga que la bujía Bosch, reemplazar la tuerca de conexión enroscada A por la tuerca B adjuntada, más larga.

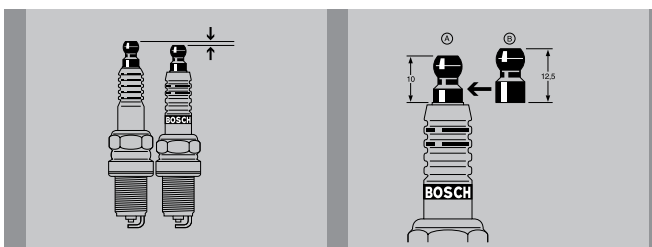
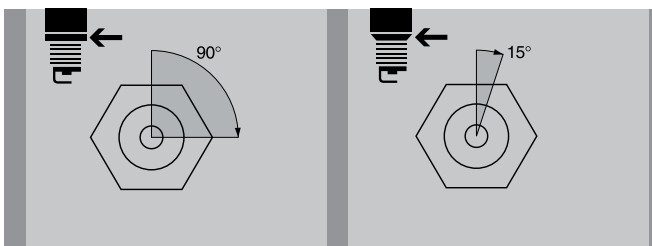

## ¡A tener en cuenta!

Las recomendaciones de bujías de encendido han sido establecidas por Bosch, siempre y cuando no procedan del fabricante del vehículo o del motor. Las bujías de encendido recomendadas rigen para condiciones de servicio normales en modelos de serie, pero no para ejecuciones de competición, especiales y de alto rendimiento, a no ser que se indiquen de forma especial tales modelos.

El uso de otros grados térmicos distintos a los recomendados puede ser necesario por condiciones especiales de servicio. Separación específica entre electrodos. Si no hay bujías disponibles con la separación específica entre electrodos, será necesario reajustar la separación entre los mismos.



Marca / Modelo	Motor	Años	Doble Iridio		Iridio		Doble Platino		Platino		Super 4		Níquel	
			Fórmula	Nº. de Parte	Fórmula	Nº. de Parte	Fórmula	Nº. de Parte	Fórmula	Nº. de Parte	Fórmula	Nº. de Parte	Fórmula	Nº. de Parte

**ACURA**

ILX	L4 2.0L	2013-2015	YR7SII3520X*	0242135557*										
	L4 2.4L	2016-2020	VR6NII352U*	0242140555*										
MDX	V6 3.5L	2014-2020	YR7SII3520X*	0242135557*										
		2005-2006	FR7LII33X	0242236592			FR7LPP33X	0242236626	FR7LPP30X	0242236614				
	V6 3.7L	2010-2013	YR6SII330X	0242140523										
2007-2009		FR6LII330X	0242240675			FR6LPP330X	0242240687	FR6LPP300X	0242240683					
RDX	V6 3.5L	2013-2018	YR6SII330X	0242140523										
RL	V6 3.5L	2005-2008	FR6LII330X	0242240675			FR6LPP330X	0242240687	FR6LPP300X	0242240683				
	V6 3.7L	2009-2011	YR6SII330X	0242140523										
RLX	V6 3.5L	2014-2015	YR7SII3520X*	0242135557*										
TL	V6 3.2L	2005-2008	FR6LII330X	0242240675			FR6LPP330X	0242240687	FR6LPP300X	0242240683				
	V6 3.5L	2012-2013	YR7SII3520X*	0242135557*										
		2009-2011	YR6SII330X	0242140523										
V6 3.7L	2011-2013	YR6SII330X	0242140523											
TLX	L4 2.4L	2015-2019	VR6NII352U*	0242140555*										
	V6 3.5L	2018-2020	VR6NII352U*	0242140555*										
		2015-2019	YR7SII3520X*	0242135557*										
TSX	L4 2.4L	2009-2013	YR6SII330X	0242140523										
	V6 3.5L	2011-2013	YR6SII330X	0242140523										
ZDX	V6 3.7L	2010-2011	YR6SII330X	0242140523										

**ALFA ROMEO**

166	V6 3.0L	2002-2003			FR5KI332S	0242245571								
4C	L4 1.7L	2016-2017	VR6NII332	0242140557										
Brera	V6 3.2L	2007-2008						HR7MPP302X	0242235767					
Giulietta	L4 1.7L	2014-2019	VR6NII332	0242140557										
GT	L4 2.0L	2007-2008			FR6KI332S	0242240653			FR7DPP30T	0242236618	FR78	0242232501	FR7DC+	0242235666
	V6 3.2L	2007-2007			FR5KI332S	0242245571								
GTV	V6 3.0L	2003-2003			FR5KI332S	0242245571								
Spider	V6 3.2L	2007-2008						HR7MPP302X	0242235767					
Sportwagon	L4 2.0L	2002-2002			FR6KI332S	0242240653			FR7DPP30T	0242236618	FR78	0242232501	FR7DC+	0242235666



Marca / Modelo	Motor	Años	Doble Iridio		Iridio		Doble Platino		Platino		Super 4		Níquel	
			Fórmula	Nº. de Parte	Fórmula	Nº. de Parte	Fórmula	Nº. de Parte	Fórmula	Nº. de Parte	Fórmula	Nº. de Parte	Fórmula	Nº. de Parte

**AUDI**

A1	L4 1.4L	2015-2018					Y5KPP332	0241145523							
		2011-2014			FR6HI332	0242240665									
A3	L4 1.4L	2012-2013			FR6HI332	0242240665									
		2008-2013					FR5KPP332S	0242245576							
	L4 1.8L	2004-2004									FR78	0242232501			
		2001-2003									FR78X	0242232502			
		1998-2004						FR7KPP33+	0242236564						
		1998-2003											FR6DC+	0242240593	
	L4 2.0L	2017-2019						FQ5NPP332S	0241245673						
		2009-2013						FR5KPP332S	0242245576						
2004-2008				FR6KI332S	0242240653							FR7DE2	0242235797		
L4 2.0L Turbo	2005-2011					FR5KPP332S	0242245576								
A3 Quattro	L4 2.0L	2005-2011					FR5KPP332S	0242245576							
	L4 2.0L Turbo	2006-2007					FR5KPP332S	0242245576							
	V6 3.2L	2004-2004					YR7LPP332W	0242135510							
A4	L4 1.8L	2009-2013					FR5KPP332S	0242245576							
		1999-2008					FR7KPP33+	0242236564							
		1998-2008									FR78	0242232501			
		1998-1999											FR7LDC+	0242235668	
	L4 2.0L	1997-1999	FR7DII33X	0242236596				FR8DPP33X	0242230579						
		1997-1998								FR7DPP30T	0242236618	FR78X	0242232502	FR6DC+	0242240593
		2017-2019						FQ5NPP332S	0241245673						
		2006-2013						FR5KPP332S	0242245576						
V6 2.8L	1997-1997	FR7DII33X	0242236596			FR8DPP33X	0242230579			FR78X	0242232502	FR7LDC+	0242235668		
V6 3.2L	2006-2007												FGR7KQE0	0242235715	
	2005-2005								FR7DPP30X	0242236616					
A4 Quattro	L4 1.8L	1999-2005					FR7KPP33+	0242236564			FR78	0242232501			
		1999-1999											FR7LDC+	0242235668	
	L4 2.0L	2017-2019						FQ5NPP332S	0241245673						
		2006-2013						FR5KPP332S	0242245576						
V6 2.8L	1998-2001	FR6KII33X	0242240669												

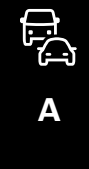

Marca / Modelo	Motor	Años	Doble Iridio		Iridio		Doble Platino		Platino		Super 4		Níquel	
			Fórmula	Nº. de Parte	Fórmula	Nº. de Parte	Fórmula	Nº. de Parte	Fórmula	Nº. de Parte	Fórmula	Nº. de Parte	Fórmula	Nº. de Parte
A4 Quattro	V6 2.8L	1997-2001											FGR7DQE+	0242235748
		1997-1998											FR7LDC+	0242235668
		1997-1997	FR7DII33X	0242236596			FR8DPP33X	0242230579			FR78X	0242232502		
	V6 3.2L	2005-2008											FGR7KQE0	0242235715
A5	L4 2.0L	2018-2019					FQ5NPP332S	0241245673						
		2012-2013					FR5KPP332S	0242245576						
	V6 3.0L	2015-2016					FR5KPP332S	0242245576						
A5 Quattro	L4 2.0L	2011-2013					FR5KPP332S	0242245576						
A5 Sportback	L4 2.0L	2019-2019					FQ5NPP332S	0241245673						
A6	L4 2.0L	2013-2014					FR5KPP332S	0242245576						
	V6 2.8L	2009-2011					FR7KPP332	0242235776						
		1998-2001	FR6KII33X	0242240669									FGR7DQE+	0242235748
		1998-1998											FR7LDC+	0242235668
	V6 3.0L	2005-2006					FR7KPP332	0242235776						
		2002-2004	FR7DII33X	0242236596					FR7DPP30X	0242236616				
	V6 3.2L	2009-2009					FR7KPP332	0242235776						
2006-2009								FR7DPP30X	0242236616					
A6 Quattro	L4 2.0L	2018-2018					FQ5NPP332S	0241245673						
	V6 2.8L	1998-2001	FR6KII33X	0242240669									FGR7DQE+	0242235748
		1998-1998											FR7LDC+	0242235668
	V6 3.0L	2010-2017					FR5KPP332S	0242245576						
		2005-2006					FR7KPP332	0242235776						
	V6 3.2L	2002-2004	FR7DII33X	0242236596					FR7DPP30X	0242236616				
		2006-2009							FR7DPP30X	0242236616			FGR7KQE0	0242235715
V8 4.2L	2005-2011											FGR7KQE0	0242235715	
A7	V6 3.0L	2016-2016					FR5KPP332S	0242245576						
A7 Quattro	V6 3.0L	2012-2017					FR5KPP332S	0242245576						
A8	V6 3.0L	2015-2016					FR5KPP332S	0242245576						
	V8 3.7L	2000-2000											FR6DC+	0242240593
Quattro	V6 3.0L	2013-2019					FR5KPP332S	0242245576						
	V8 4.2L	2006-2006	FR6KII33X	0242240669									FGR7KQE0	0242235715
		2001-2006											HGR7KQC	0242235607
		1997-1999												



A



Marca / Modelo	Motor	Años	Doble Iridio		Iridio		Doble Platino		Platino		Super 4		Níquel	
			Fórmula	Nº. de Parte	Fórmula	Nº. de Parte	Fórmula	Nº. de Parte	Fórmula	Nº. de Parte	Fórmula	Nº. de Parte	Fórmula	Nº. de Parte
Allroad Quattro	V6 2.7L	2003-2004					FR7KPP33+	0242236564						
		2002-2004									FR78	0242232501		
Cabriolet	V6 2.8L	1997-1998	FR7DII33X	0242236596			FR8DPP33X	0242230579					FR7LDC+	0242235668
Q3	L4 2.0L	2013-2015					FR5KPP332S	0242245576						
Q5	V6 3.0L	2017-2017					FR5KPP332S	0242245576						
	V6 3.2L	2010-2012	FR8KII33X	0242230528			FR8DPP33X	0242230579	FR8DPP30X	0242230557				
Q7	V6 3.0L	2011-2019					FR5KPP332S	0242245576						
	V6 3.6L	2007-2010	YR6TII330T	0242140528										
R8	V10 5.2L	2011-2017					FR5KPP332S	0242245576						
	V8 4.2L	2009-2016					FR5KPP332S	0242245576						
		2008-2010											FGR7KQE0	0242235715
RS5	V8 4.2L	2011-2016					FR5KPP332S	0242245576						
RS6	V10 5.0L	2010-2010					FR6KPP332S	0242240627						
S3	L4 1.8L	2000-2004					FR7KPP33+	0242236564						
		2000-2003									FR78	0242232501		
	L4 2.0L	2017-2018					FQ5NPP332S	0241245673						
S4	V6 3.0L	2010-2013					FR5KPP332S	0242245576						
	V8 4.2L	2004-2008											FGR7KQE0	0242235715
S5	V6 3.0L	2016-2016					FR5KPP332S	0242245576						
	V8 4.2L	2008-2011			FR6K1332S	0242240653								
		2008-2008											FGR7KQE0	0242235715
S6	V8 4.2L	2001-2004											FGR6KQE	0242240587
S8	V8 4.2L	2001-2002											FGR7KQE0	0242235715
SQ5	V6 3.0L	2017-2017					FR5KPP332S	0242245576						
TT	L4 1.8L	2016-2016					FQ5NPP332S	0241245673						
		2011-2014					FR5KPP332S	0242245576						
		2000-2006									FR78	0242232501		
		1999-2006					FR7KPP33+	0242236564						
	1999-1999									FR78X	0242232502	FR6DC+	0242240593	
	L4 2.0L	2016-2016						FQ5NPP332S	0241245673					
2010-2010							FR6KPP332S	0242240627						
2007-2014							FR5KPP332S	0242245576						









Marca / Modelo	Motor	Años	Doble Iridio		Iridio		Doble Platino		Platino		Super 4		Níquel	
			Fórmula	Nº. de Parte	Fórmula	Nº. de Parte	Fórmula	Nº. de Parte	Fórmula	Nº. de Parte	Fórmula	Nº. de Parte	Fórmula	Nº. de Parte
TT Quattro	L4 1.8L	2014-2014					FR5KPP332S	0242245576						
		2000-2006					FR7KPP33+	0242236564			FR78	0242232501		
	L4 2.0L	2017-2018					FQ5NPP332S	0241245673						
		2014-2014					FR5KPP332S	0242245576						
TTS Quattro	V6 3.2L	2007-2009					YR7LPP332W	0242135510						
		L4 2.0L	2017-2018					FQ5NPP332S	0241245673					
			2010-2014					FR5KPP332S	0242245576					

## BMW

118i	L4 1.6L	2012-2015			ZR5SI332	0242145537								
120i	L4 1.6L	2016-2016			ZR5SI332	0242145537								
	L4 2.0L	2005-2012					FR7KPP332	0242235776						
128i	L6 3.0L	2013-2013					FR7NPP332	0242236510	FR7SPP302U	0242236653				
130i	L6 3.0L	2006-2009					FR7NPP332	0242236510						
135i	L6 3.0L	2012-2013					ZR5TPP33	0242145515						
235i	L6 3.0L	2014-2014					ZR5TPP33	0242145515						
320i	L4 2.0L	2014-2018					ZR5TPP330	0242145541						
	L6 2.2L	2001-2005							FGR7DQP+	0242236562				
323i	L6 2.5L	1999-2001							FGR7DQP+	0242236562				
		1997-1997					FR7DPP33X	0242236631	FR7DPP30T	0242236618	FR78X	0242232502	FR7LDC+	0242235668
323ti	L6 2.5L	1999-2000					FR7DPP33X	0242236631	FR7DPP30T	0242236618	FR78X	0242232502	FR7LDC+	0242235668
325Ci	L6 2.5L	2001-2006							FGR7DQP+	0242236562				
325i	L6 2.5L	2001-2005							FGR7DQP+	0242236562				
		1995-1997					FR7DPP33X	0242236631						
	L6 3.0L	2011-2013										ZGR6STE2	0242140507	
328i	L6 2.8L	1999-2000							FGR7DQP+	0242236562				
		1996-1998							FR8DPP30T	0242230572			FLR8LDCU+	0242229654
	L6 3.0L	2012-2013					ZR5TPP330	0242145541						
330Ci	L6 3.0L	2001-2006						FGR7DQP+	0242236562					
330e	L4 2.0L	2017-2018					ZR5SPP3320	0242145555						
330i	L4 2.0L	2017-2019					ZR5SPP3320	0242145555						
	L6 3.0L	2001-2005							FGR7DQP+	0242236562				
335i	L6 3.0L	2012-2015					ZR5TPP33	0242145515						



Marca / Modelo	Motor	Años	Doble Iridio		Iridio		Doble Platino		Platino		Super 4		Níquel	
			Fórmula	Nº. de Parte	Fórmula	Nº. de Parte	Fórmula	Nº. de Parte	Fórmula	Nº. de Parte	Fórmula	Nº. de Parte	Fórmula	Nº. de Parte
335i	L6 3.0L	2007-2010											ZGR6STE2	0242140507
340i	L6 3.0L	2016-2018					ZR5SPP3320	0242145555						
430i	L4 2.0L	2017-2019					ZR5SPP3320	0242145555						
430i Gran Coupe	L4 2.0L	2018-2019					ZR5SPP3320	0242145555						
435i	L6 3.0L	2014-2016					ZR5TPP33	0242145515						
435i Gran Coupe	L6 3.0L	2015-2016					ZR5TPP33	0242145515						
440i	L6 3.0L	2017-2019					ZR5SPP3320	0242145555						
440i Gran Coupe	L6 3.0L	2018-2019					ZR5SPP3320	0242145555						
525i	L6 2.5L	2001-2003							FGR7DQP+	0242236562				
528i	L6 2.8L	1999-2000							FGR7DQP+	0242236562				
		1999-1999											FR7LDC+	0242235668
		1997-1998							FR8DPP30T	0242230572			FLR8LDCU+	0242229654
	L6 3.0L	2011-2011						FR7SPP302U	0242236653					
530e	L4 2.0L	2018-2019					ZR5SPP3320	0242145555						
530i	L6 3.0L	2017-2019					ZR5SPP3320	0242145555						
		2010-2010											ZGR6STE2W	0242140560
		2006-2010					FR7NPP332	0242236510						
		2001-2005						FGR7DQP+	0242236562					
535i	L6 3.0L	2011-2016					ZR5TPP33	0242145515						
535i GT	L6 3.0L	2013-2013					ZR5TPP33	0242145515						
540i	V8 4.4L	2018-2019					ZR5SPP3320	0242145555						
		1999-2003							FGR7DQP+	0242236562				
		1997-2003	FR7DII33X	0242236596			FR7DPP33X	0242236631			FR78X	0242232502	FR7LDC+	0242235668
545i	V8 4.4L	2004-2006							FGR7DQP+	0242236562				
550i	V8 4.4L	2013-2013					ZR5TPP33	0242145515						
	V8 4.8L	2006-2010					FR7KPP332	0242235776						
640i Gran Coupe	L6 3.0L	2016-2016					ZR5TPP33	0242145515						
645Ci	V8 4.4L	2005-2005							FGR7DQP+	0242236562				

 Marca / Modelo	 Motor	 Años	 Doble Iridio		 Iridio		 Doble Platino		 Platino		 Super 4		 Níquel	
			Fórmula	Nº. de Parte	Fórmula	Nº. de Parte	Fórmula	Nº. de Parte	Fórmula	Nº. de Parte	Fórmula	Nº. de Parte	Fórmula	Nº. de Parte
650i	V8 4.4L	2013-2018					ZR5TPP330	0242145541						
		2012-2012					ZR5TPP33	0242145515						
650i Gran Coupe	V8 4.4L	2015-2019					ZR5TPP330	0242145541						
740i	L6 3.0L	2016-2019					ZR5SPP3320	0242145555						
		2013-2015					ZR5TPP33	0242145515						
		2010-2012											ZGR6STE2	0242140507
	V8 4.4L	1999-2001							FGR7DQP+	0242236562				
		1998-2001	FR7DII33X	0242236596			FR7DPP33X	0242236631			FR78X	0242232502	FR7LDC+	0242235668
740iL	V8 4.4L	2000-2001	FR7DII33X	0242236596			FR7DPP33X	0242236631	FGR7DQP+	0242236562	FR78X	0242232502	FR7LDC+	0242235668
745i	V8 4.4L	2002-2005						FGR7DQP+	0242236562					
745Li	V8 4.4L	2003-2005						FGR7DQP+	0242236562					
750i	V8 4.4L	2012-2012					ZR5TPP33	0242145515						
	V8 4.8L	2006-2009					FR7KPP332	0242235776						
750iL	V12 5.4L	1995-2001							FGR7DQP+	0242236562				
	V8 4.8L	2006-2008					FR7KPP332	0242235776						
760Li	V12 6.0L	2014-2015					ZR5TPP33	0242145515						
		2003-2008							FGR7DQP+	0242236562				
850Ci	V12 5.4L	1995-1997						FGR7DQP+	0242236562					
Active Hybrid 3	L6 3.0L	2014-2015					ZR5TPP33	0242145515						
Active Hybrid 5	L6 3.0L	2014-2015					ZR5TPP33	0242145515						
M2	L6 3.0L	2017-2019					ZR5TPP330	0242145541						
M235i	L6 3.0L	2015-2016					ZR5TPP33	0242145515						
M240i	L6 3.0L	2017-2019					ZR5SPP3320	0242145555						
M3	L6 3.0L	2015-2018					ZR5TPP330	0242145541						
		1995-1995	FR7DII33X	0242236596			FR7DPP33X	0242236631	FR7DPP30T	0242236618			FR7LDC+	0242235668
	2001-2006											YR6LDE	0242140504	
	L6 3.2L	1996-1999							FR8DPP30X	0242230557			FGR8KQE	0242229613
		1996-1996										FR7LDC+	0242235668	
M4	L6 3.0L	2015-2019					ZR5TPP330	0242145541						
M5	V8 4.4L	2012-2016					ZR5TPP330	0242145541						





Marca / Modelo	Motor	Años	Doble Iridio		Iridio		Doble Platino		Platino		Super 4		Níquel	
			Fórmula	Nº. de Parte	Fórmula	Nº. de Parte	Fórmula	Nº. de Parte	Fórmula	Nº. de Parte	Fórmula	Nº. de Parte	Fórmula	Nº. de Parte
M5	V8 4.9L	2000-2003							FGR7DQP+	0242236562				
M6	V8 4.4L	2014-2018					ZR5TPP330	0242145541						
M6 Gran Coupe	V8 4.4L	2014-2019					ZR5TPP330	0242145541						
X1	L4 2.0L	2016-2016					ZR5SPP3320	0242145555						
		2012-2012					ZR5TPP330	0242145541						
X3	L4 2.0L	2018-2019					ZR5SPP3320	0242145555						
	L6 2.5L	2007-2008					FR7NPP332	0242236510						
		2004-2006							FGR7DQP+	0242236562				
X3	L6 3.0L	2018-2019					ZR5SPP3320	0242145555						
		2011-2017					ZR5TPP33	0242145515						
		2010-2012							FR7SPP302U	0242236653				
		2007-2010					FR7NPP332	0242236510						
		2004-2006						FGR7DQP+	0242236562					
X4	L4 2.0L	2019-2019					ZR5SPP3320	0242145555						
	L6 3.0L	2017-2018					ZR5TPP330	0242145541						
		2015-2018					ZR5TPP33	0242145515						
X5	L4 2.0L	2016-2018					ZR5TPP330	0242145541						
		2012-2018					ZR5TPP33	0242145515						
		2010-2010							FR7SPP302U	0242236653				
	L6 3.0L	2007-2010					FR7NPP332	0242236510						
		2001-2006							FGR7DQP+	0242236562				
	V8 4.4L	2015-2018					ZR5TPP330	0242145541						
		2011-2013					ZR5TPP33	0242145515						
2000-2006								FGR7DQP+	0242236562					
V8 4.8L	2005-2010					FR7KPP332	0242235776							
	2005-2005							FGR7DQP+	0242236562					
X6	L6 3.0L	2011-2019					ZR5TPP33	0242145515						
		2015-2019					ZR5TPP330	0242145541						
	V8 4.4L	2011-2014					ZR5TPP33	0242145515						
Z3	L4 1.9L	1996-1998	FR7DII33X	0242236596			FR7DPP33X	0242236631	FR7DPP30T	0242236618			FR7LDC+	0242235668
	L6 2.0L	2000-2000									FR78X	0242232502	FR7LDC+	0242235668





Marca / Modelo	Motor	Años	Doble Iridio		Iridio		Doble Platino		Platino		Super 4		Níquel	
			Fórmula	Nº. de Parte	Fórmula	Nº. de Parte	Fórmula	Nº. de Parte	Fórmula	Nº. de Parte	Fórmula	Nº. de Parte	Fórmula	Nº. de Parte

**CADILLAC**

ATS	L4 2.0L	2013-2019	HR7NII332S	0242236675											
	V6 3.6L	2016-2019	HR6MII33T	0242240711											
Catera	V6 3.0L	1997-2001							FR7DPP30X	0242236616					
CTS	L4 2.0L	2015-2019	HR7NII332S	0242236675											
	V6 3.0L	2010-2013	HR7NII33X	0242236591			HR7MPP33X	0242236629	HR7MPP30X	0242236617					
	V6 3.2L	2003-2003											FGR8KQE0	0242229648	
	V6 3.6L	2010-2014	HR7NII33X	0242236591			HR7MPP33X	0242236629	HR7MPP30X	0242236617					
		2005-2010							HR8NPP302	0242229739					
		2004-2009	HR8NII332X	0242230530											
	V8 6.2L	2004-2005							HR7MPP302X	0242235767					
2016-2019		HR7NII33T	0242236674												
DeVille	V8 4.6L	2012-2014	HR8LI33U	0242230523			HR8LPP33U	0242230577	HR8LPP30U	0242230558					
		2000-2004	HR7DII33V	0242236594			HR7DPP33V	0242236625							
		1995-1999	HR8KII33V	0242230535			HR8DPP33V	0242230583	HR8DPP30V	0242230561					
	1994-1994	HR8KII33Y	0242230536			HR8DPP33Y	0242230581	HR8DPP30Y	0242230559						
V8 4.9L	1991-1995	HR8KII33Y	0242230536			HR8DPP33Y	0242230581	HR8DPP30Y	0242230559						
Eldorado	V8 4.6L	1994-1994	HR8KII33Y	0242230536			HR8DPP33Y	0242230581	HR8DPP30Y	0242230559					
Escalade	V8 6.0L	2002-2006	HR8LII33U	0242230523			HR8LPP33U	0242230577	HR8LPP30U	0242230558					
	V8 6.2L	2015-2020	HR8SII33W	0242230615											
		2007-2016	HR8LII33U	0242230523			HR8LPP33U	0242230577	HR8LPP30U	0242230558					
Escalade ESV	V8 6.2L	2015-2020	HR8SII33W	0242230615											
		2009-2015	HR8LII33U	0242230523					HR8LPP30U	0242230558					
Escalade EXT	V8 6.0L	2002-2006	HR8LII33U	0242230523			HR8LPP33U	0242230577	HR8LPP30U	0242230558					
	V8 6.2L	2007-2013	HR8LII33U	0242230523			HR8LPP33U	0242230577	HR8LPP30U	0242230558					
Seville	V8 4.6L	2000-2004	HR7DII33V	0242236594			HR7DPP33V	0242236625							
		1995-1999	HR8KII33V	0242230535			HR8DPP33V	0242230583	HR8DPP30V	0242230561					
		1994-1994	HR8KII33Y	0242230536			HR8DPP33Y	0242230581	HR8DPP30Y	0242230559					
SRX	V6 3.0L	2010-2011	HR7NII33X	0242236591			HR7MPP33X	0242236629	HR7MPP30X	0242236617					
	V6 3.6L	2012-2016	HR7NII33X	0242236591			HR7MPP33X	0242236629	HR7MPP30X	0242236617					
		2005-2006							HR8NPP302	0242229739					

Marca / Modelo	Motor	Años	Doble Iridio		Iridio		Doble Platino		Platino		Super 4		Níquel	
			Fórmula	Nº. de Parte	Fórmula	Nº. de Parte	Fórmula	Nº. de Parte	Fórmula	Nº. de Parte	Fórmula	Nº. de Parte	Fórmula	Nº. de Parte
SRX	V6 3.6L	2004-2006	HR8NII332X	0242230530										
		2004-2004							HR7MPP302X	0242235767				
	V8 4.6L	2004-2006	HR7DII33V	0242236594				HR7DPP33V	0242236625					
STS	V6 3.6L	2010-2010	HR7NII33X	0242236591				HR7MPP33X	0242236629	HR7MPP30X	0242236617			
		2006-2009	HR8NII332X	0242230530						HR8NPP302	0242229739			
	V8 4.6L	2005-2010	HR7DII33V	0242236594				HR7DPP33V	0242236625					
XLR	V8 4.6L	2004-2006	HR7DII33V	0242236594				HR7DPP33V	0242236625					

## CHEVROLET

Astra	L4 1.8L	2008-2008											FR7DC+	0242235666
		2006-2008					FR8LPP33X	0242230580	FR8LPP30X	0242230560			FQR8LEU2	0242229699
		2000-2003							FR8DPP30T	0242230572			FLR8LDCU+	0242229654
	L4 2.0L	2004-2008						FR7DPP30X	0242236616	WR78	0242232504			
Astra	L4 2.2L	2001-2003											HLR8STEX	0242229661
		L4 2.4L	2004-2006										FLR8LDCU+	0242229654
Avalanche	V8 5.3L	2007-2013	HR8LI33U	0242230523			HR8LPP33U	0242230577	HR8LPP30U	0242230558				
Avalanche 1500	V8 5.3L	2002-2006	HR8LI33U	0242230523			HR8LPP33U	0242230577	HR8LPP30U	0242230558				
Aveo	L4 1.5L	2018-2020											YR7ME	0242135545
		2012-2018	FR7DII33X	0242236596			FR7DPP33X	0242236631	FR7DPP30X	0242236616			FR7DCX+	0242235667
		2008-2011											FQR8LEU2	0242229699
Blazer	V6 4.3L	1996-2001	HR9KII33Y	0242225659			HR9DPP33Y	0242225677	HR9DPP30Y	0242225670			FR8DCX+	0242229660
		1995-1995	HR9BII33V	0242225665					HR9BPP30V	0242225671				
C10	L6 4.1L	1976-1981	HR9BII33V	0242225665					HR9BPP30X	0242225673				
		1975-1981					HR8DPP33Y	0242230581						
		1975-1975	HR8KII33Y	0242230536					HR8DPP30Y	0242230559				
	L6 4.8L	1975-1979	HR9BII33V	0242225665					HR9BPP30X	0242225673				
	V8 5.7L	1980-1981	HR9BII33V	0242225665					HR9BPP30X	0242225673				
C15	L6 4.1L	1982-1988	HR9BII33V	0242225665					HR9BPP30X	0242225673				
		L6 4.8L	1982-1986						HR7BPP30X	0242236615				
C1500	V6 4.3L	1999-2002	HR9KII33Y	0242225659			HR9DPP33Y	0242225677	HR9DPP30Y	0242225670				
C20	V8 5.7L	1986-1987							HR7BPP30X	0242236615				
C2500	V8 5.7L	1996-1999	HR9KII33Y	0242225659			HR9DPP33Y	0242225677	HR9DPP30Y	0242225670				
		1988-1994	HR9BII33V	0242225665					HR9BPP30V	0242225671				



Marca / Modelo	Motor	Años	Doble Iridio		Iridio		Doble Platino		Platino		Super 4		Níquel		
			Fórmula	Nº. de Parte	Fórmula	Nº. de Parte	Fórmula	Nº. de Parte	Fórmula	Nº. de Parte	Fórmula	Nº. de Parte	Fórmula	Nº. de Parte	
C30	L6 4.1L	1980-1980	HR9BII33V	0242225665					HR9BPP30X	0242225673					
	V8 5.7L	1975-1980	HR9BII33V	0242225665					HR9BPP30X	0242225673					
C35	L6 4.8L	1987-1987							HR7BPP30X	0242236615					
	V8 5.7L	1996-2000	HR9KII33Y	0242225659			HR9DPP33Y	0242225677	HR9DPP30Y	0242225670					
Camaro	L4 2.0L	2016-2018	HR7NII332S	0242236675											
	V6 3.6L	2010-2015	HR7NII33X	0242236591			HR7MPP33X	0242236629	HR7MPP30X	0242236617					
	V6 3.8L	1996-1998	HR9KII33Y	0242225659			HR9DPP33Y	0242225677	HR9DPP30Y	0242225670					
	V8 5.7L	1999-2002	HR8LII33U	0242230523				HR8LPP33U	0242230577	HR8LPP30U	0242230558				
		1996-1996						HR8DPP33V	0242230583	HR8DPP30V	0242230561				
		1995-1996	HR8KII33V	0242230535											
	1995-1995						HR9DPP33Y	0242225677	HR9DPP30Y	0242225670					
V8 6.2L	2016-2020	HR8SII33W	0242230615												
	2010-2015	HR8LII33U	0242230523				HR8LPP33U	0242230577	HR8LPP30U	0242230558					
Caprice	V8 5.7L	1980-1981	HR9BII33V	0242225665					HR9BPP30X	0242225673					
Captiva Sport	L4 2.4L	2008-2015			HR8NI332W	0242230508									
	L6 3.0L	2014-2014	HR7NII33X	0242236591			HR7MPP33X	0242236629	HR7MPP30X	0242236617					
		2012-2013											HR8MCV+	0242229785	
	2011-2015	HR7NII33X	0242236591				HR7MPP33X	0242236629	HR7MPP30X	0242236617					
V6 3.6L	2008-2010	HR8NII332X	0242230530					HR8NPP302X	0242230573						
Cavalier	L4 2.2L	1998-2002	HR8DII33X	0242230524				HR8DPP33X	0242230588	HR8DPP30X	0242230569				
		1995-1997	HR8JII33V	0242230555				HR8JPP33V	0242230589	HR8JPP302V	0242230563				
	L4 2.4L	1996-1996	HR8KII33V	0242230535				HR8DPP33V	0242230583	HR8DPP30V	0242230561				
	V6 2.8L	1990-1994	HR9LII33X	0242225661				HR9LPP33X	0242225678	HR9LPP30X	0242225674				
V6 3.1L	1991-1994	HR9LII33X	0242225661				HR9LPP33X	0242225678	HR9LPP30X	0242225674					
	1987-1989	HR9LII33X	0242225661				HR9LPP33X	0242225678	HR9LPP30X	0242225674					
Celebrity	V6 2.8L	1982-1986							HR7BPP30X	0242236615					
	L4 1.4L	1994-2002							WR7DPP30W	0242236647			WR7DC+	0242235663	
Chevy	L4 1.6L	1996-2012							WR7DPP30W	0242236647			WR7DC+	0242235663	
	Chevy Monza	L4 1.6L	2003-2003						WR7DPP30W	0242236647			WR7DC+	0242235663	
Chevy Pickup	L4 1.6L	2000-2003									WR78	0242232504			
		1999-2003							WR7DPP30W	0242236647			WR7DC+	0242235663	
Cheyenne	V8 5.3L	2014-2019	HR8SII33W	0242230615											
		2007-2013	HR8LII33U	0242230523			HR8LPP33U	0242230577	HR8LPP30U	0242230558					

Marca / Modelo	Motor	Años	Doble Iridio		Iridio		Doble Platino		Platino		Super 4		Níquel	
			Fórmula	Nº. de Parte	Fórmula	Nº. de Parte	Fórmula	Nº. de Parte	Fórmula	Nº. de Parte	Fórmula	Nº. de Parte	Fórmula	Nº. de Parte
Cheyenne	V8 6.2L	2014-2019	HR8SII33W	0242230615										
Citation	V6 2.8L	1982-1986							HR7BPP30X	0242236615				
Colorado	L4 2.5L	2016-2020	HR8MII33X	0242230611										
	L4 2.9L	2011-2012	HR8MII33X	0242230611			HR8MPP33X	0242230582	HR8MPP30X	0242230564			HR9DCY+	0242225623
	L5 3.5L	2004-2006	HR8MII33X	0242230611			HR8MPP33X	0242230582	HR8MPP30X	0242230564				
	L5 3.7L	2007-2012	HR8MII33X	0242230611			HR8MPP33X	0242230582	HR8MPP30X	0242230564			HR9DCY+	0242225623
Corsa	L4 1.4L	2013-2016	HR7NII33X	0242236591			HR7MPP33X	0242236629	HR7MPP30X	0242236617				
		2002-2002							FR8DPP30T	0242230572			FLR8LDCU+	0242229654
	L4 1.8L	2006-2008											WR7DC+	0242235663
		2003-2008							WR8DPP30W	0242230599	WR78	0242232504		
Corvette	V8 5.7L	2003-2005											WR7KC+	F000KE0P43
		1997-2003	HR8LII33U	0242230523			HR8LPP33U	0242230577	HR8LPP30U	0242230558				
		1995-2004											HR8DCX+	0242229775
		1993-1996					HR9DPP33Y	0242225677	HR9DPP30Y	0242225670				
		1992-1996	HR8KII33V	0242230535										
		1992-1994	HR8KII33Y	0242230536			HR8DPP33Y	0242230581	HR8DPP30Y	0242230559				
	1992-1992					HR8DPP33V	0242230583	HR8DPP30V	0242230561					
	1991-1992	FR7DII33X	0242236596			FR7DPP33X	0242236631	FR7DPP30T	0242236618			FR8DC+	0242229659	
	V8 6.0L	2005-2007	HR8LII33U	0242230523			HR8LPP33U	0242230577	HR8LPP30U	0242230558				
V8 6.2L	2014-2019	HR8SII33W	0242230615											
	2008-2013	HR8LII33U	0242230523			HR8LPP33U	0242230577	HR8LPP30U	0242230558					
V8 6.2L Supercargado	2015-2018	HR7NII33T	0242236674											
Cruze	L4 1.4L	2014-2015	FR7KII332S	0242236668										
	L4 1.8L	2014-2016	FR8LII33X	0242230531			FR7LPP33X	0242236626					FR7LCX+	0242236542
		2010-2013	FR7DII33X	0242236596			FR7DPP33X	0242236631	FR7DPP30X	0242236616			FR7DC+	0242235666
Epica	L6 2.5L	2009-2009					FR6KPP33X+	0242240649						
Equinox	L4 2.4L	2016-2017			HR8NI332W	0242230508								
	V6 3.4L	2005-2008	HR9KII33Y	0242225659			HR9DPP33Y	0242225677	HR9DPP30Y	0242225670			FR8DCX+	0242229660
Express 1500	V6 4.3L	1998-2008	HR9KII33Y	0242225659			HR9DPP33Y	0242225677	HR9DPP30Y	0242225670				
	V8 5.3L	2003-2008	HR8LII33U	0242230523			HR8LPP33U	0242230577	HR8LPP30U	0242230558				
	V8 5.7L	1998-2002	HR9KII33Y	0242225659			HR9DPP33Y	0242225677	HR9DPP30Y	0242225670				
Express 2500	V8 5.7L	1999-1999	HR9KII33Y	0242225659			HR9DPP33Y	0242225677	HR9DPP30Y	0242225670				



C

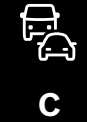

Marca / Modelo	Motor	Años	Doble Iridio		Iridio		Doble Platino		Platino		Super 4		Níquel	
			Fórmula	Nº. de Parte	Fórmula	Nº. de Parte	Fórmula	Nº. de Parte	Fórmula	Nº. de Parte	Fórmula	Nº. de Parte	Fórmula	Nº. de Parte
Express 3500	V8 4.8L	2004-2004	HR8LII33U	0242230523			HR8LPP33U	0242230577	HR8LPP30U	0242230558				
	V8 5.3L	2003-2008	HR8LII33U	0242230523			HR8LPP33U	0242230577	HR8LPP30U	0242230558				
	V8 5.7L	1998-2002	HR9KII33Y	0242225659			HR9DPP33Y	0242225677	HR9DPP30Y	0242225670			HR9DCY+	0242225623
	V8 6.0L	2004-2004	HR8LII33U	0242230523			HR8LPP33U	0242230577	HR8LPP30U	0242230558				
Express Cargo	V6 4.3L	2018-2018	HR8SII33W	0242230615										
		2009-2009	HR9KII33Y	0242225659			HR9DPP33Y	0242225677	HR9DPP30Y	0242225670				
	V8 6.0L	2010-2016	HR8LII33U	0242230523			HR8LPP33U	0242230577	HR8LPP30U	0242230558				
Express Pasajeros	V8 5.3L	2010-2015	HR8LII33U	0242230523			HR8LPP33U	0242230577	HR8LPP30U	0242230558				
	V8 6.0L	2010-2018	HR8LII33U	0242230523			HR8LPP33U	0242230577	HR8LPP30U	0242230558				
G20	V6 4.3L	1995-1995	HR9BII33V	0242225665					HR9BPP30V	0242225671				
G30	V6 4.3L	2001-2002	HR9KII33Y	0242225659					HR9DPP30Y	0242225670				
Impala	V6 3.8L	2000-2003	HR9KII33Y	0242225659					HR9DPP30Y	0242225670				
	V8 5.7L	1975-1975	HR9BII33V	0242225665					HR9BPP30X	0242225673				
Lumina Van	V6 3.8L	1995-1996	HR8KII33Y	0242230536			HR8DPP33Y	0242230581	HR8DPP30Y	0242230559				
LUV	L4 2.2L	2005-2005											WR9DC+	0242225599
		1999-2005							WR8DPP30W	0242230599				
	L4 2.3L	1997-1997							HR9DPP30Y	0242225670			WR8DCX+	0242229687
Malibu	L4 2.0L	2013-2019	HR7NII332S	0242236675										
	L4 2.2L	2004-2005	HR8MII33X	0242230611			HR8MPP33X	0242230582	HR8MPP30X	0242230564				
	L4 2.4L	2009-2012	HR8MII33X	0242230611			HR8MPP33X	0242230582	HR8MPP30X	0242230564				
		1997-1999	HR8KII33V	0242230535			HR8DPP33V	0242230583	HR8DPP30V	0242230561				
	L4 2.5L	2013-2015	HR8MII33X	0242230611										
	L6 4.1L	1979-1981	HR9BII33V	0242225665					HR9BPP30X	0242225673				
	V6 3.1L	2002-2003	HR9KII33Y	0242225659			HR9DPP33Y	0242225677	HR9DPP30Y	0242225670				
		1997-2001	HR8KII33Y	0242230536			HR8DPP33Y	0242230581	HR8DPP30Y	0242230559				
	V6 3.5L	2007-2008	HR9LII33X	0242225661			HR9LPP33X	0242225678	HR9LPP30X	0242225674				
	V6 3.5L	2006-2006	HR9KII33Y	0242225659			HR9DPP33Y	0242225677	HR9DPP30Y	0242225670				
	V6 3.6L	2011-2012	HR7NII33X	0242236591			HR7MPP33X	0242236629	HR7MPP30X	0242236617				
		2009-2010	HR8NII332X	0242230530					HR8NPP302	0242229739				
	V8 5.7L	1980-1981							HR9BPP30X	0242225673				
1975-1981		HR9BII33V	0242225665											
		1975-1979						HR9BPP30V	0242225671					
Matiz	L4 1.0L	2011-2015						WR8DPP30W	0242230599			WR9DC+	0242225599	

Marca / Modelo	Motor	Años	Doble Iridio		Iridio		Doble Platino		Platino		Super 4		Níquel	
			Fórmula	Nº. de Parte	Fórmula	Nº. de Parte	Fórmula	Nº. de Parte	Fórmula	Nº. de Parte	Fórmula	Nº. de Parte	Fórmula	Nº. de Parte
Meriva	L4 1.8L	2004-2008							WR8DPP30W	0242230599	WR78	0242232504	WR7KC+	F000KE0P43
Nova	L6 4.1L	1975-1978	HR9BII33V	0242225665					HR9BPP30X	0242225673				
	V8 5.7L	1977-1978	HR9BII33V	0242225665					HR9BPP30X	0242225673				
Optra	L4 2.0L	2006-2010							FR8DPP30T	0242230572			FLR8LDCU+	0242229654
P30	V8 5.7L	2000-2005	HR8KII33V	0242230535			HR8DPP33V	0242230583	HR8DPP30V	0242230561				
		1997-1998	HR9KII33Y	0242225659			HR9DPP33Y	0242225677	HR9DPP30Y	0242225670				
		1991-1996	HR9BII33V	0242225665					HR9BPP30V	0242225671				
		1991-1994												HR9BC+
S10	L4 2.2L	1995-2003	HR8DII33X	0242230524			HR8DPP33X	0242230588	HR8DPP30X	0242230569				
		1995-1995	HR8JII33V	0242230555			HR8JPP33V	0242230589	HR8JPP302V	0242230563				
	V6 3.1L	1991-1993											HR9BC+	0242225622
S10 Blazer	V6 3.1L	1991-1994							HR7BPP30X	0242236615			HR9BC+	0242225622
Silverado	V8 5.7L	1995-1999	HR8KII33Y	0242230536			HR8DPP33Y	0242230581	HR8DPP30Y	0242230559			HR9DCY+	0242225623
Silverado 1500	V6 4.3L	2017-2020	HR8SII33W	0242230615										
		2002-2009	HR9KII33Y	0242225659			HR9DPP33Y	0242225677	HR9DPP30Y	0242225670				
	V8 5.3L	2007-2008	HR8LII33U	0242230523			HR8LPP33U	0242230577	HR8LPP30U	0242230558				
Silverado 2500	V6 4.3L	2017-2017	HR8SII33W	0242230615										
	V8 4.8L	2007-2009	HR8LII33U	0242230523			HR8LPP33U	0242230577	HR8LPP30U	0242230558				
	V8 5.3L	2017-2018	HR8SII33W	0242230615										
	V8 5.3L	2001-2016	HR8LII33U	0242230523			HR8LPP33U	0242230577	HR8LPP30U	0242230558				
Silverado 3500	V8 6.0L	2008-2017	HR8LII33U	0242230523			HR8LPP33U	0242230577	HR8LPP30U	0242230558				
	V8 8.1L	2001-2003	HR9LII33X	0242225661			HR9LPP33X	0242225678	HR9LPP30X	0242225674				
Sonic	L4 1.4L	2014-2016	FR6KII332S	0242240707										
Sonora	V8 5.7L	2000-2002	HR8KII33Y	0242230536			HR8DPP33Y	0242230581	HR8DPP30Y	0242230559			HR8DC+	0242229655
Spark	L4 1.2L	2014-2015											YR7DC+	0242135515
		2011-2013									YR78X	0242132501		
Suburban	V8 5.3L	2014-2020	HR8SII33W	0242230615										
	V8 5.7L	1990-1994	HR9BII33V	0242225665					HR9BPP30V	0242225671				
	V8 6.0L	2017-2019	HR8LII33U	0242230523			HR8LPP33U	0242230577	HR8LPP30U	0242230558				
Suburban 1500	V8 5.3L	2003-2013	HR8LII33U	0242230523			HR8LPP33U	0242230577	HR8LPP30U	0242230558				
		1996-1999	HR9KII33Y	0242225659			HR9DPP33Y	0242225677	HR9DPP30Y	0242225670				
	V8 5.7L	1995-2002					HR8DPP33Y	0242230581					HR8DCX+	0242229775
		2010-2013	HR8LII33U	0242230523			HR8LPP33U	0242230577	HR8LPP30U	0242230558				



C





Marca / Modelo	Motor	Años	Doble Iridio		Iridio		Doble Platino		Platino		Super 4		Níquel		
			Fórmula	Nº. de Parte	Fórmula	Nº. de Parte	Fórmula	Nº. de Parte	Fórmula	Nº. de Parte	Fórmula	Nº. de Parte	Fórmula	Nº. de Parte	
300	V6 2.7L	2010-2010	HR8SII330V	0242230542					HR8SPP300V	0242230575					
	V6 3.5L	2006-2008					FR8VPP332V	0242230591							
	V6 3.6L	2012-2019	YR7SII3320U	0242135574	YR7SII302U	0242135555									
	V8 5.7L	2009-2019	FR8SII33X	0242230571											
		2009-2013					FR8SPP33X	0242230604	FR8SPP30X	0242230576			FR8SEX	0242230624	
	2005-2008	HR9SII330X	0242225664			HR9SPP330X	0242225680	HR9SPP300X	0242225672			HR9SEX	0242225668		
	V8 6.1L	2006-2008	HR8SII330V	0242230542					HR8SPP300V	0242230575					
300M	V6 3.5L	1999-2004					FR8VPP332V	0242230591							
Aspen	V8 5.7L	2009-2009	FR8SII33X	0242230571			FR8SPP33X	0242230604	FR8SPP30X	0242230576			FR8SEX	0242230624	
		2007-2008	HR9SII330X	0242225664			HR9SPP330X	0242225680	HR9SPP300X	0242225672			HR9SEX	0242225668	
Breeze	L4 2.0L	1996-1996							WR7DPP30W	0242236647			WR7DCX+	0242235707	
Chrysler R/T	L4 2.4L	1997-1997	FR8KII33X	0242230528			FR8DPP33X	0242230579	FR8DPP30X	0242230557			FR7DCX+	0242235667	
Cirrus	L4 2.4L	1998-2010	FR8KII33X	0242230528			FR8DPP33X	0242230579	FR8DPP30X	0242230557			FR7DCX+	0242235667	
	V6 2.5L	1996-2000	FR8DII33X	0242230534			FR8DPP33X	0242230579	FR8DPP30X	0242230557					
	V6 2.7L	2004-2006	FR8DII33X	0242230534			FR8DPP33X	0242230579	FR8DPP30X	0242230557					
	V6 3.5L	2007-2010					FR8VPP332V	0242230591							
Concorde	V6 3.2L	2001-2001	FR8VII33U	0242230532			FR8VPP332V	0242230591							
	V6 3.5L	2002-2002					FR8VPP332V	0242230591							
		1993-1997	FR8VII33U	0242230532			FR8VPP33U	0242230585	FR8VPP30U	0242230565					
Cordoba	V8 5.9L	1980-1980					WR8LPP33X	0242230587	WR8DPP30W	0242230599			WR8DCX+	0242229687	
Crossfire	V6 3.2L	2004-2007	FR8KII33X	0242230528			FR8DPP33+	0242230500	FR8DPP30X	0242230557					
Grand Voyager	V6 3.8L	1996-2000							WR8LPP30V	0242230574					
		1994-2000					WR8LPP33X	0242230587							
		1994-1995							WR8DPP30W	0242230599			WR8DCX+	0242229687	
Imperial	V6 3.3L	1991-1991					WR8LPP33X	0242230587							
Intrepid	V6 3.5L	1994-1997	FR8VII33U	0242230532			FR8VPP33U	0242230585	FR8VPP30U	0242230565					
LeBaron	L4 2.2L	1983-1987						WR8LPP33X	0242230587	WR8DPP30W	0242230599			WR8DCX+	0242229687
		1986-1987								WR8DPP30W	0242230599				
		1984-1987						WR8LPP33X	0242230587						
	L4 2.5L	1993-1995												WR8DCX+	0242229687
		1991-1995						WR8LPP33X	0242230587	WR8DPP30W	0242230599				
	V8 5.9L	1979-1982					WR8LPP33X	0242230587	WR8DPP30W	0242230599					
LHS	V6 3.5L	1996-1997	FR8VII33U	0242230532			FR8VPP33U	0242230585	FR8VPP30U	0242230565					



C



Marca / Modelo	Motor	Años	Doble Iridio		Iridio		Doble Platino		Platino		Super 4		Níquel	
			Fórmula	Nº. de Parte	Fórmula	Nº. de Parte	Fórmula	Nº. de Parte	Fórmula	Nº. de Parte	Fórmula	Nº. de Parte	Fórmula	Nº. de Parte
Neon	L4 2.0L	1995-1997							FR8DPP30T	0242230572			FR8DC+	0242229659
		1995-1997							FR7DPP30T	0242236618	FR78	0242232501	FR7DC+	0242235666
New Yorker	L4 2.2L	1985-1988					WR8LPP33X	0242230587	WR8DPP30W	0242230599			WR8DCX+	0242229687
	L4 2.2L Turbo	1985-1986							WR8DPP30W	0242230599				
Pacifica	V6 3.5L	1995-1995	FR8VII33U	0242230532				FR8VPP33U	0242230585	FR8VPP30U	0242230565			
	V6 3.5L	2004-2006						FR8VPP332V	0242230591					
	V6 3.6L	2017-2019	YR7SII3320U	0242135574										
	V6 3.8L	2007-2007	HR8TII3302V	0242230526				HR8TTP3302V	0242230586	HR8TTP3002V	0242230566			
Phantom	L4 2.2L	1988-1989											WR9DC+	0242225599
	L4 2.4L	2001-2010	HR9SII330X	0242225664				HR9SPP330X	0242225680	HR9SPP300X	0242225672			HR9SE0X
PT Cruiser	L4 2.4L	2006-2007											HR9SE0X	0242225668
	L4 2.4L Turbo	2006-2007											HR9SE0X	0242225668
Shadow	L4 2.2L	1989-1990					WR8LPP33X	0242230587	WR8DPP30W	0242230599			WR8DCX+	0242229687
	L4 2.5L	1989-1994					WR8LPP33X	0242230587	WR8DPP30W	0242230599			WR8DCX+	0242229687
Spirit	L4 2.5L	1990-1995					WR8LPP33X	0242230587	WR8DPP30W	0242230599			WR8DCX+	0242229687
Stratus	L4 2.0L	1995-1997							WR7DPP30W	0242236647	FR78	0242232501	WR7DCX+	0242235707
	L4 2.4L	1995-1997	FR8KII33X	0242230528				FR8DPP33X	0242230579	FR8DPP30X	0242230557			FR8DCX+
Town & Country	V6 3.3L	2010-2010	HR8TII3302V	0242230526				HR8TTP3302V	0242230586	HR8TTP3002V	0242230566			
	V6 3.6L	2011-2016	YR7SII3320U	0242135574	YR7SII302U	0242135555								
	V6 3.8L	2001-2010	HR8TII3302V	0242230526				HR8TTP3302V	0242230586	HR8TTP3002V	0242230566			
		1996-2000								WR8LPP30V	0242230574			
		1994-2000							WR8LPP33X	0242230587				
	1994-1995								WR8DPP30W	0242230599			WR8DCX+	0242229687
V6 4.0L	2008-2010						FR8VPP332V	0242230591						
Voyager	V6 3.3L	2001-2003	HR8TII3302V	0242230526				HR8TTP3302V	0242230586	HR8TTP3002V	0242230566			
		1994-2000						WR8LPP33X	0242230587	WR8LPP30V	0242230574			

## DODGE









Atos	L4 1.0L	2001-2004											FR8DCX+	0242229660	
		2001-2004	FR8DII33X	0242230534				FR8DPP33X	0242230579	FR8DPP30X	0242230557	FR78X	0242232502	FR7DCX+	0242235667
Attitude	L4 1.1L	2005-2012	FR8DII33X	0242230534				FR8DPP33X	0242230579	FR8DPP30X	0242230557	FR78X	0242232502	FR7DCX+	0242235667
	L3 1.2L	2017-2017						FR7SI30	0242235769						
	L4 1.4L	2006-2014	FR8KII33X	0242230528				FR8DPP33X	0242230579	FR8DPP30X	0242230557			FR7DCX+	0242235667

Marca / Modelo	Motor	Años	Doble Iridio		Iridio		Doble Platino		Platino		Super 4		Níquel		
			Fórmula	Nº. de Parte	Fórmula	Nº. de Parte	Fórmula	Nº. de Parte	Fórmula	Nº. de Parte	Fórmula	Nº. de Parte	Fórmula	Nº. de Parte	
Attitude	L4 1.6L	2012-2014	YR8SII33U	0242129524											
		2012-2013												FR7DCX+	0242235667
		2006-2013							FR8DPP33X	0242230579	FR8DPP30X	0242230557			
		2006-2011	FR8DII33X	0242230534										FR8DCX+	0242229660
Avenger	L4 2.0L	2008-2010	FR8LI33X	0242230531			FR8LPP33X	0242230580	FR8LPP30X	0242230560			FR8LCX	0242229576	
	L4 2.4L	2008-2014	FR8LI33X	0242230531			FR8LPP33X	0242230580	FR8LPP30X	0242230560			FR8LCX	0242229576	
	V6 3.5L	2008-2009					FR8VPP332V	0242230591							
B2500	V8 5.2L	1997-1998							FR8HPP30X	0242230567					
		1995-1998	FR8DII33X	0242230534			FR8DPP33X	0242230579							
		1995-1995					WR8LPP33X	0242230587	FR8DPP30X	0242230557			FR8DCX+	0242229660	
		1995-1995							WR8DPP30W	0242230599			WR8DCX+	0242229687	
B3500	V8 5.2L	1997-1998							FR8HPP30X	0242230567					
		1995-1998									FR78X	0242232502			
		1995-1996	FR8DII33X	0242230534			FR8DPP33X	0242230579	FR8DPP30X	0242230557			FR8DCX+	0242229660	
		1995-1996					WR8LPP33X	0242230587	WR8DPP30W	0242230599			WR8DCX+	0242229687	
Caliber	L4 2.4L	2007-2012	FR8LI33X	0242230531			FR8LPP33X	0242230580	FR8LPP30X	0242230560			FR8LCX	0242229576	
Challenger	V6 3.6L	2013-2019	YR7SII3320U	0242135574	YR7SII302U	0242135555									
	V8 5.7L	2009-2014	FR8SII33X	0242230571			FR8SPP33X	0242230604	FR8SPP30X	0242230576					
		2009-2013											FR8SEX	0242230624	
	V8 6.1L	2008-2009	HR8SII330V	0242230542					HR8SPP300V	0242230575					
V8 6.2L	2015-2019			FR7SI332	0242236655										
Charger	V6 3.5L	2006-2010					FR8VPP332V	0242230591							
	V8 5.7L	2009-2019	FR8SII33X	0242230571											
		2009-2012					FR8SPP33X	0242230604	FR8SPP30X	0242230576			FR8SEX	0242230624	
		2006-2008	HR9SII330X	0242225664			HR9SPP330X	0242225680	HR9SPP300X	0242225672			HR9SEOX	0242225668	
	V8 6.1L	2007-2010	HR8SII330V	0242230542					HR8SPP300V	0242230575					
V8 6.2L	2015-2019			FR7SI332	0242236655										
Coronet	L6 3.7L	1968-1970											WR9DC+	0242225599	
D100	L6 3.7L	1976-1977											HR9BC+	0242225622	
D100 Panel	L6 3.7L	1976-1976											HR9BC+	0242225622	
D150	L6 3.7L	1984-1990	HR9BII33V	0242225665											
		1983-1990							HR9BPP30X	0242225673			HR9BC+	0242225622	
		1981-1982							HR9SPP300X	0242225672					





Marca / Modelo	Motor	Años	Doble Iridio		Iridio		Doble Platino		Platino		Super 4		Níquel		
			Fórmula	Nº. de Parte	Fórmula	Nº. de Parte	Fórmula	Nº. de Parte	Fórmula	Nº. de Parte	Fórmula	Nº. de Parte	Fórmula	Nº. de Parte	
D150	V6 3.9L	1991-1993					WR8LPP33X	0242230587	WR8DPP30W	0242230599			WR8DCX+	0242229687	
	V8 5.9L	1982-1988					WR8LPP33X	0242230587	WR8DPP30W	0242230599			WR8DCX+	0242229687	
D250	V8 5.9L	1986-1992					WR8LPP33X	0242230587	WR8DPP30W	0242230599			WR8DCX+	0242229687	
D300	L6 3.7L	1976-1977											HR9BC+	0242225622	
	V8 5.9L	1980-1980					WR8LPP33X	0242230587	WR8DPP30W	0242230599			WR8DCX+	0242229687	
D350	V8 5.9L	1981-1992					WR8LPP33X	0242230587	WR8DPP30W	0242230599			WR8DCX+	0242229687	
Dakota	L4 2.5L	1996-1996					WR8LPP33X	0242230587	WR8DPP30W	0242230599			WR8DCX+	0242229687	
	V6 3.7L	2005-2012	FR7LII33X	0242236592					FR8LPP302X	0242230570	FR78X	0242232502	FR7LCX+	0242236542	
Dart	L4 2.4L	2014-2016	FR8SII332X	0242230618											
Durango	V6 3.6L	2014-2015	YR7SII3320U	0242135574	YR7SII302U	0242135555									
	V8 4.7L	2001-2007	FR8KII332X	0242230556					FR8LPP302X	0242230570	FR78X	0242232502	FR8LCX	0242229576	
	V8 5.7L	2009-2019	FR8SII33X	0242230571											
		2009-2017					FR8SPP33X	0242230604	FR8SPP30X	0242230576					
		2009-2013												FR8SEX	0242230624
		2004-2008	HR9SII330X	0242225664			HR9SPP330X	0242225680	HR9SPP300X	0242225672				HR9SE0X	0242225668
	V8 5.9L	1999-2003							FR8HPP30X	0242230567					
Grand Caravan	V6 3.6L	2017-2019	YR7SII3320U	0242135574	YR7SII302U	0242135555									
H100	L4 2.4L	2003-2005											WR7DC+	0242235663	
H100 Van	L4 2.4L	2012-2013	FR8MII33X	0242230533			FR8MPP33X	0242230584	FR8MPP30X	0242230562					
i10	L4 1.1L	2012-2014	FR8DII33X	0242230534			FR8DPP33X	0242230579	FR8DPP30X	0242230557	FR78X	0242232502	FR8DCX+	0242229660	
Intrepid	V6 3.2L	1998-2000	FR8VII33U	0242230532			FR8VPP332V	0242230591	FR8VPP30U	0242230565					
	V6 3.5L	2000-2001	FR8VII33U	0242230532			FR8VPP332V	0242230591							
Journey	L4 2.4L	2009-2020	FR8LII33X	0242230531					FR8LPP30X	0242230560					
		2009-2019					FR8LPP33X	0242230580					FR8LCX	0242229576	
	V6 3.5L	2009-2010					FR8VPP332V	0242230591							
Neon	L4 1.4L	2017-2017												YR7DC+	0242135515
		2000-2005				FR6KI332S	0242240653								
	L4 2.0L	1998-2005	FR7DII33X	0242236596			FR7DPP33X	0242236631	FR7DPP30T	0242236618	FR78X	0242232502	FR7DC+	0242235666	
L4 2.4L	2004-2005	HR9SII330X	0242225664			HR9SPP330X	0242225680	HR9SPP300X	0242225672				HR9SE0X	0242225668	
Nitro	V6 3.7L	2007-2011	FR7LII33X	0242236592					FR8LPP302X	0242230570	FR78X	0242232502	FR7LCX+	0242236542	
	V6 4.0L	2007-2010					FR8VPP332V	0242230591							

 Marca / Modelo	 Motor	 Años	 Doble Iridio		 Iridio		 Doble Platino		 Platino		 Super 4		 Níquel	
			Fórmula	Nº. de Parte	Fórmula	Nº. de Parte	Fórmula	Nº. de Parte	Fórmula	Nº. de Parte	Fórmula	Nº. de Parte	Fórmula	Nº. de Parte
Ram 1500	V10 8.3L	2005-2006	FR8VII33U	0242230532			FR8VPP33U	0242230585	FR8VPP30U	0242230565				
	V6 3.7L	2003-2010	FR7LII33X	0242236592					FR8LPP302X	0242230570			FR7LCX+	0242236542
		2003-2008									FR78X	0242232502		
	V6 3.9L	1998-2002							FR8HPP30X	0242230567				
		1994-1999	FR8DII33X	0242230534			FR8DPP33X	0242230579	FR8DPP30X	0242230557			FR8DCX+	0242229660
	V8 4.7L	2008-2009			FR8TI332	0242229764							FR8TE2	0242229765
		2003-2009	FR8KII332X	0242230556					FR8LPP302X	0242230570				
	V8 5.2L	2003-2008									FR78X	0242232502	FR8LCX	0242229576
		1998-2000							FR8HPP30X	0242230567				
	V8 5.7L	1995-2000	FR8DII33X	0242230534										
1995-1999						FR8DPP33X	0242230579	FR8DPP30X	0242230557			FR8DCX+	0242229660	
V8 5.9L	2006-2008	HR9SII330X	0242225664					HR9SPP300X	0242225672	HR9SPP300X	0242225672		HR9SE0X	0242225668
	1999-2001							FR8HPP30X	0242230567					
	1995-2001	FR8DII33X	0242230534											
V8 5.9L	1995-1999					FR8DPP33X	0242230579	FR8DPP30X	0242230557			FR8DCX+	0242229660	
	1999-2003							FR8HPP30X	0242230567					
	1999-2002							FR8HPP30X	0242230567					
Ram 1500 Van	V6 3.9L	1999-2003												
	V8 5.2L	1999-2002												
		1999-1999	FR8DII33X	0242230534										
	V8 4.7L	2008-2009											FR7LCX+	0242236542
		2002-2009	FR8KII332X	0242230556					FR8LPP302X	0242230570				
		2002-2008											FR8LCX	0242229576
2000-2001								FR8HPP30X	0242230567					
V8 5.7L	2009-2009	FR8SII33X	0242230571			FR8SPP33X	0242230604	FR8SPP30X	0242230576			FR8SEX	0242230624	
	2003-2008	HR9SII330X	0242225664			HR9SPP330X	0242225680	HR9SPP300X	0242225672			HR9SE0X	0242225668	
	1998-2002							FR8HPP30X	0242230567					
V8 5.9L	1997-1999	FR8DII33X	0242230534			FR8DPP33X	0242230579	FR8DPP30X	0242230557			FR8DCX+	0242229660	
	1995-1996					WR8LPP33X	0242230587	WR8DPP30W	0242230599			WR8DCX+	0242229687	
Ram 2500 Van	V8 5.2L	1999-2002						FR8HPP30X	0242230567					
Ram 3500	V8 5.9L	1998-2002							FR8HPP30X	0242230567				
		1994-1999	FR8DII33X	0242230534			FR8DPP33X	0242230579	FR8DPP30X	0242230557			FR8DCX+	0242229660
Ram 3500 Van	V8 5.2L	1999-2002							FR8HPP30X	0242230567				
	V8 5.9L	1999-2002							FR8HPP30X	0242230567				
		1997-2002	FR8DII33X	0242230534										





Marca / Modelo	Motor	Años	Doble Iridio		Iridio		Doble Platino		Platino		Super 4		Níquel		
			Fórmula	Nº. de Parte	Fórmula	Nº. de Parte	Fórmula	Nº. de Parte	Fórmula	Nº. de Parte	Fórmula	Nº. de Parte	Fórmula	Nº. de Parte	
Ramcharger	V8 5.2L	2000-2001							FR8HPP30X	0242230567			FR7LCX+	0242236542	
	V8 5.9L	1995-2001	FR8DII33X	0242230534				FR8DPP33X	0242230579	FR8DPP30X	0242230557			FR8DC+	0242229659
		1980-1993						WR8LPP33X	0242230587	WR8DPP30W	0242230599			WR8DCX+	0242229687
Stratus	L4 2.0L	2001-2006	HR9SII330X	0242225664					HR9SPP300X	0242225672			FR8DCX+	0242229660	
		1998-2000	FR7DII33X	0242236596			FR7DPP33X	0242236631	FR7DPP30T	0242236618	FR78	0242232501	FR7DC+	0242235666	
	L4 2.4L	2004-2005	HR8SII330V	0242230542					HR8SPP300V	0242230575					
		2001-2006	HR9SII330X	0242225664					HR9SPP330X	0242225680	HR9SPP300X	0242225672		HR9SE0X	0242225668
		1998-2004							FR8DPP33X	0242230579					
	L4 2.4L Turbo	1998-2000	FR8KII33X	0242230528					FR8DPP30X	0242230557				FR8DCX+	0242229660
		2006-2006	HR9SII330X	0242225664					HR9SPP300X	0242225672					
	2001-2006					HR9SPP330X	0242225680								
Van 1000	L4 2.4L	2008-2009							WR7DPP30W	0242236647	WR78X	0242232505	WR7DCX+	0242235707	
Verna	L4 1.5L	2004-2006	FR8DII33X	0242230534				FR8DPP33X	0242230579	FR8DPP30X	0242230557			FR8DCX+	0242229660
	L4 1.6L	2004-2006	FR8DII33X	0242230534				FR8DPP33X	0242230579	FR8DPP30X	0242230557	FR78X	0242232502	FR8DCX+	0242229660
Viper	V10 8.0L	1992-2000	FR8VII33U	0242230532				FR8VPP33U	0242230585	FR8VPP30U	0242230565				
	V10 8.3L	2003-2006	FR8VII33U	0242230532				FR8VPP33U	0242230585	FR8VPP30U	0242230565				
	V10 8.4L	2008-2015	HR8SII330V	0242230542						HR8SPP300V	0242230575				
W150	L6 3.7L	1985-1986	HR9BII33V	0242225665						HR9BPP30X	0242225673				
	V8 5.9L	1985-1986					WR8LPP33X	0242230587	WR8DPP30W	0242230599			WR8DCX+	0242229687	

### FAW

F1	L3 1.0L	2008-2009												FR7DCX+	0242235667
F4	L4 1.4L	2008-2008												FR7DCX+	0242235667

### FERRARI

F355	V8 3.5L	1999-1999												UR6DE	0242040502
F355 Spider	V8 3.5L	2000-2001												UR6DE	0242040502

### FIAT

500	L4 1.4L	2014-2019	YR5DII33S	0242145571											
		2014-2017					FR8MPP33X	0242230584	FR8MPP30X	0242230562					
		2009-2013												YR7DC+	0242135515
		2009-2011									YR78X	0242132501			

Marca / Modelo	Motor	Años	Doble Iridio		Iridio		Doble Platino		Platino		Super 4		Níquel	
			Fórmula	Nº. de Parte	Fórmula	Nº. de Parte	Fórmula	Nº. de Parte	Fórmula	Nº. de Parte	Fórmula	Nº. de Parte	Fórmula	Nº. de Parte
500	L4 1.4L Turbo	2012-2017	YR5DII33S	0242145571										
500L	L4 1.4L	2015-2019	YR5DII33S	0242145571										
500X	L4 2.4L	2016-2017	FR8SII332X	0242230618										
Idea	L4 1.8L	2008-2009									WR78	0242232504	WR7DC+	0242235663
Palio	L4 1.6L	2004-2005									FR78X	0242232502	FR8DC+	0242229659
	L4 1.8L	2005-2009									WR78	0242232504	WR7DC+	0242235663
Punto	L4 1.4L	2007-2009			YR6KI332S	0242140514								
Stilo	L5 2.4L	2007-2007									FR78X	0242232502	FR7LDC+	0242235668
Strada	L4 1.8L	2007-2008									WR78	0242232504	WR7DC+	0242235663

**FORD**









Aerostar	V6 3.0L	1991-1992	HR7DII33V	0242236594			HR7DPP33V	0242236625	HR7DPP30V	0242236658			HR8DCX+	0242229775
	V6 4.0L	1993-1995	HR8DII33X	0242230524			HR8DPP33V	0242230583	HR8DPP30V	0242230561			HR8DCX+	0242229775
		1993-1995	HR8KII33V	0242230535			HR8DPP33X	0242230588	HR8DPP30X	0242230569				
B-150	V8 5.0L	1981-1985	HR9BII33V	0242225665					HR9BPP30X	0242225673				
Club Wagon	V8 5.4L	1998-1998	HR7KII33V	0242236603			HR7DPP33Y	0242236628	HR7DPP30Y	0242236613				
		1997-1997	HR7DII33V	0242236594			HR7DPP33V	0242236625	HR7DPP30V	0242236658				
	V8 5.8L	1995-1996							HR7BPP30X	0242236615				
Contour	L4 2.0L	1996-1996	HR7NII33X	0242236591			HR7MPP33X	0242236629	HR7NPP30V	0242236672				
	V6 2.5L	1996-2000	HR7KII33V	0242236603			HR7DPP33V	0242236625	HR7DPP30V	0242236658				
Cougar	V6 3.8L	1990-1994	HR8JII33V	0242230555			HR8JPP33V	0242230589	HR8JPP302V	0242230563				
	V8 4.6L	1995-1995	HR7DII33V	0242236594			HR7DPP33V	0242236625	HR7DPP30V	0242236658			HR8DCX+	0242229775
Courier	L4 1.6L	2001-2012											HR7MCU	0242235657
Crown Victoria	V8 4.6L	2011-2011	HR8DII33X	0242230524			HR8DPP33X	0242230588	HR8DPP30X	0242230569				
		2009-2011											HR8DCX+	0242229775
		2000-2008					HR7DPP33V	0242236625						
		2000-2000	HR6KII33X	0242240671										
		1998-2008	HR7DII33V	0242236594					HR7DPP30V	0242236658				
	1998-2000												HR9DCY+	0242225623
E-150	V6 4.2L	2002-2003	HR8JII33V	0242230555			HR8JPP33V	0242230589	HR8JPP302V	0242230563				
	V8 4.6L	2004-2008	HR7DII33V	0242236594			HR7DPP33V	0242236625	HR7DPP30V	0242236658				
	V8 5.4L	2002-2007	HR7KII33V	0242236603			HR7DPP33Y	0242236628	HR7DPP30Y	0242236613				



F













 Marca / Modelo	 Motor	 Años	 Doble Iridio		 Iridio		 Doble Platino		 Platino		 Super 4		 Níquel	
			Fórmula	Nº. de Parte	Fórmula	Nº. de Parte	Fórmula	Nº. de Parte	Fórmula	Nº. de Parte	Fórmula	Nº. de Parte	Fórmula	Nº. de Parte
Expedition	V8 4.6L	1997-2004					HR7DPP33V	0242236625	HR7DPP30V	0242236658				
		1997-2000	HR7KII33V	0242236603										
	V8 5.4L	2008-2014	AR7TII330U	0242135565										
		2002-2002	HR6KII33X	0242240671			HR6DPP33X	0242240688						
		1998-2008							HR7DPP30Y	0242236613				
		1998-2004	HR7KII33V	0242236603			HR7DPP33Y	0242236628						
		1997-2002							HR7DPP30V	0242236658				
1997-1997	HR7DII33V	0242236594			HR7DPP33V	0242236625								
Explorer	V6 3.5L	2011-2019							HR7NPP30V	0242236672				
		2011-2017					HR7MPP33X	0242236629						
	V6 4.0L	2005-2010	HR8JII33V	0242230555			HR8JPP33V	0242230589	HR8JPP302V	0242230563				
		1997-2005	HR7DII33V	0242236594			HR7DPP33V	0242236625	HR7DPP30V	0242236658				
		1991-2010											HR8DCX+	0242229775
		1991-1996	HR8KII33V	0242230535			HR8DPP33V	0242230583	HR8DPP30V	0242230561				
	1991-1995	HR8DII33X	0242230524			HR8DPP33X	0242230588	HR8DPP30X	0242230569					
	V8 4.6L	2008-2010	AR7TII330U	0242135565										
		2002-2005	HR7DII33V	0242236594			HR7DPP33V	0242236625	HR7DPP30V	0242236658				
	V8 5.0L	1996-2001	HR7KII33V	0242236603			HR7DPP33V	0242236625	HR7DPP30V	0242236658				
Explorer Sport	V6 4.0L	2001-2003	HR7DII33V	0242236594			HR7DPP33V	0242236625	HR7DPP30V	0242236658				
Explorer Sport Trac	V8 4.6L	2008-2010	AR7TII330U	0242135565										
F-100	V8 5.0L	1978-1979	HR9BII33V	0242225665					HR9BPP30X	0242225673			HR9BC+	0242225622
F-100 Ranger	L4 2.3L	2001-2001	HR8DII33X	0242230524			HR8DPP33X	0242230588	HR8DPP30X	0242230569			HR8DCX+	0242229775
		1996-2001												
	1996-1997	HR7KII33V	0242236603			HR7DPP33V	0242236625	HR7DPP30V	0242236658					
	L4 2.5L	1998-2000	HR7KII33V	0242236603			HR7DPP33V	0242236625	HR7DPP30V	0242236658			HR8DCX+	0242229775
	V6 3.0L	2000-2000	HR7DII33V	0242236594			HR6DPP33X	0242240688						
1997-2001		HR7KII33V	0242236603			HR7DPP33V	0242236625	HR7DPP30V	0242236658					
F-150	V6 3.3L	2018-2020							HR7NPP30V	0242236672				
	V6 3.5L	2015-2017							HR7NPP30V	0242236672				
	V6 3.7L	2011-2014							HR7NPP30V	0242236672				
	V6 4.2L	1998-2008	HR8JII33V	0242230555			HR8JPP33V	0242230589	HR8JPP302V	0242230563				
	V8 5.0L	2011-2017	HR7NII33X	0242236591			HR7MPP33X	0242236629	HR7MPP30X	0242236617				













Marca / Modelo	Motor	Años	Doble Iridio		Iridio		Doble Platino		Platino		Super 4		Níquel	
			Fórmula	Nº. de Parte	Fórmula	Nº. de Parte	Fórmula	Nº. de Parte	Fórmula	Nº. de Parte	Fórmula	Nº. de Parte	Fórmula	Nº. de Parte
F-150	V8 5.0L	1984-1985							HR7BPP30X	0242236615				
		1980-1985	HR9BII33V	0242225665										
		1980-1983							HR9BPP30X	0242225673				
	V8 5.8L	1984-1985							HR9BPP30X	0242225673				
		1984-1985	HR9BII33V	0242225665					HR7BPP30X	0242236615				
F-200	V8 5.0L	1986-1991							HR7BPP30X	0242236615				
F-250	V8 4.6L	2000-2009	HR7DII33V	0242236594										
		1997-2009					HR7DPP33V	0242236625	HR7DPP30V	0242236658				
		1997-2001	HR7KII33V	0242236603										
	V8 5.0L	1992-1997	HR9BII33V	0242225665					HR9BPP30X	0242225673				
		1992-1995							HR7BPP30X	0242236615				
	V8 5.4L	2001-2001	HR7KII33V	0242236603			HR7DPP33Y	0242236628	HR7DPP30Y	0242236613				
	V8 5.8L	1997-1997	HR9BII33V	0242225665					HR9BPP30X	0242225673				
1992-1996								HR7BPP30X	0242236615					
F-350	V8 5.0L	1984-1992							HR7BPP30X	0242236615				
		1980-1998	HR9BII33V	0242225665					HR9BPP30X	0242225673				
		1975-1981											HR9BC+	0242225622
	V8 5.4L	2008-2009	AR7TII330U	0242135565										
		2002-2003											HR8DCX+	0242229775
	V8 5.8L	1999-2004	HR7KII33V	0242236603				HR7DPP33Y	0242236628	HR7DPP30Y	0242236613			
	V8 6.2L	1995-1996							HR7BPP30X	0242236615				
V8 6.2L	2011-2016						HR6MPP33X	0242240706						
F-350 Super Duty	V8 5.4L	2008-2009	AR7TII330U	0242135565										
		2002-2004	HR7KII33V	0242236603				HR7DPP33Y	0242236628	HR7DPP30Y	0242236613			
	V8 6.2L	2017-2020						HR6MPP33X	0242240706					
		2017-2018							HR7MPP30X	0242236617				
F-450 Super Duty	V10 6.8L	2008-2019	AR7TII330U	0242135565										
		1999-2004	HR7KII33V	0242236603				HR7DPP33Y	0242236628	HR7DPP30Y	0242236613			
F-550 Super Duty	V10 6.8L	2008-2018	AR7TII330U	0242135565										
		2001-2004	HR7KII33V	0242236603				HR7DPP33Y	0242236628	HR7DPP30Y	0242236613			
Fairmont	V8 5.0L	1980-1983	HR9BII33V	0242225665					HR9BPP30X	0242225673				
Fiesta	L4 1.3L	1998-2001											HR7DCX+	0242236560
	L4 1.4L	1998-2000							HR8MPP30V	0242230601			HR8MCV+	0242229785

 Marca / Modelo	 Motor	 Años	 Doble Iridio		 Iridio		 Doble Platino		 Platino		 Super 4		 Níquel		
			Fórmula	Nº. de Parte	Fórmula	Nº. de Parte	Fórmula	Nº. de Parte	Fórmula	Nº. de Parte	Fórmula	Nº. de Parte	Fórmula	Nº. de Parte	Fórmula
Fiesta	L4 1.6L	2014-2014	HR7TII3320T	0242236683											
		2011-2019	HR7NII332S	0242236675											
		2003-2010												HR7MCU	0242235657
		2003-2003								HR8MPP30V	0242230601				
	L4 1.6L Turbo	2019-2019	HR7NII332S	0242236675											
		2015-2019	HR7TII3320T	0242236683											
Fiesta Ikon	L4 2.0L	2008-2008	HR8DII33X	0242230524			HR8DPP33V	0242230583	HR8DPP30V	0242230561					
		2002-2013							HR8MPP30X	0242230564					
Five Hundred	L4 1.6L	2002-2004											HR8MCV+	0242229785	
		2005-2007	HR7KII33V	0242236603			HR7DPP33Y	0242236628	HR7DPP30Y	0242236613					
Focus	L4 2.0L	2013-2013	HR7NII332S	0242236675											
		2008-2010					HR6DPP33V	0242240620							
		2005-2011	HR8KII33V	0242230535			HR8DPP33V	0242230583	HR8DPP30V	0242230561					
		2000-2004	HR8JII33V	0242230555			HR8JPP33V	0242230589	HR8JPP302V	0242230563					
		2000-2004	HR7NII33X	0242236591			HR7MPP33X	0242236629	HR7MPP30X	0242236617					
	L4 2.0L Turbo	2014-2015	HR7NII332S	0242236675											
	L5 2.5L	2011-2011							FR7MPP10	0242235743					
2010-2011				FR7NI33	0242236528										
Freestar	V6 4.2L	2004-2007	HR8KII33V	0242230535			HR8DPP33V	0242230583	HR8DPP30V	0242230561					
Fusion	L4 2.0L	2019-2019	HR7NII332S	0242236675											
		2017-2020	HR8MII33V	0242230612											
		2013-2018			HR7MII30T	0242236678									
	L4 2.3L	2007-2009	HR8MII33V	0242230612					HR8NPP302X	0242230573					
		2010-2018	HR8MII33V	0242230612											
	L4 2.5L	2010-2013							HR8NPP302X	0242230573					
		2010-2012	HR8KII33V	0242230535			HR8DPP33V	0242230583	HR8DPP30V	0242230561					
	V6 3.0L	2006-2009	HR7KII33V	0242236603			HR7DPP33Y	0242236628	HR7DPP30Y	0242236613					
2011-2012		HR7NII33X	0242236591			HR7MPP33X	0242236629	HR7NPP30V	0242236672						
Ghia	V6 3.0L	1991-1994	HR7DII33V	0242236594			HR7DPP33V	0242236625	HR7DPP30V	0242236658					
Grand Marquis	V8 4.6L	1995-1999	HR7KII33V	0242236603									HR9DCY+	0242225623	
		1992-2004	HR7DII33V	0242236594			HR7DPP33V	0242236625	HR7DPP30V	0242236658					
		1992-1994											HR8DCX+	0242229775	
GT	V6 3.5L	2017-2017	HR7NII332S	0242236675											





 Marca / Modelo	 Motor	 Años	 Doble Iridio		 Iridio		 Doble Platino		 Platino		 Super 4		 Níquel		
			Fórmula	Nº. de Parte	Fórmula	Nº. de Parte	Fórmula	Nº. de Parte	Fórmula	Nº. de Parte	Fórmula	Nº. de Parte	Fórmula	Nº. de Parte	
Ikona	L4 1.6L	2003-2007							HR8MPP30V	0242230601			HR8MCV+	0242229785	
Ka	L4 1.6L	2001-2008							HR8MPP30X	0242230564			HR8MCV+	0242229785	
Lobo	V8 4.6L	2009-2010	AR7TII330U	0242135565			HR8DPP33X	0242230588	HR8DPP30X	0242230569			HR8DCX+	0242229775	
		2009-2010	HR8DII33X	0242230524											
		2000-2008	HR7DII33V	0242236594											
		1997-2008					HR7DPP33V	0242236625	HR7DPP30V	0242236658					
		1997-2001	HR7KII33V	0242236603											
	V8 5.0L	2011-2017							HR7NPP30V	0242236672					
	V8 5.4L	2002-2002	HR6KII33X	0242240671			HR6DPP33X	0242240688	HR7DPP30V	0242236658					
		2001-2010	AR7TII330U	0242135565											
		1999-2003	HR7KII33V	0242236603			HR7DPP33Y	0242236628	HR7DPP30Y	0242236613					
	V8 5.4L Supercargado	2001-2001	HR6KII33X	0242240671			HR6DPP33X	0242240688	HR7DPP30V	0242236658					
V8 6.2L	2011-2014					HR6MPP33X	0242240706	HR7MPP30X	0242236617						
LTD	V8 5.8L	1980-1980	HR9BII33V	0242225665					HR9BPP30X	0242225673					
Mondeo	V6 2.5L	2001-2007	HR8NII332X	0242230530					HR8DPP15V	0242229652					
	V6 3.0L	2004-2005							HR8DPP15V	0242229652					
Mustang	L4 2.3L	2016-2019			HR7MII30T	0242236678									
	V6 3.7L	2011-2017							HR7NPP30V	0242236672					
	V8 4.0L	2007-2010	HR8JII33V	0242230555				HR8JPP33V	0242230589	HR8JPP302V	0242230563				
		2008-2010	AR7TII330U	0242135565											
		1999-2004	HR7DII33V	0242236594											
		1999-2001					HR7DPP33Y	0242236628	HR7DPP30Y	0242236613					
		1996-2004					HR7DPP33V	0242236625	HR7DPP30V	0242236658					
	1996-2001	HR7KII33V	0242236603									HR9DCY+	0242225623		
	V8 5.0L	2017-2019								HR7NPP30V	0242236672				
		2011-2017	HR7NII33X	0242236591				HR7MPP33X	0242236629						
		2011-2013								HR7MPP30X	0242236617				
		1994-1994	HR7DII33V	0242236594				HR7DPP33V	0242236625	HR7DPP30V	0242236658			HR8DCX+	0242229775
		1979-1995	HR9BII33V	0242225665						HR9BPP30X	0242225673				
2016-2017		HR7NII33X	0242236591												
V8 5.4L	2008-2012	HR6KII33X	0242240671			HR6DPP33X	0242240688	HR7DPP30V	0242236658						
Mystique	V6 2.5L	1995-2000	HR7KII33V	0242236603			HR7DPP33V	0242236625	HR7DPP30V	0242236658					

Marca / Modelo	Motor	Años	Doble Iridio		Iridio		Doble Platino		Platino		Super 4		Níquel	
			Fórmula	Nº. de Parte	Fórmula	Nº. de Parte	Fórmula	Nº. de Parte	Fórmula	Nº. de Parte	Fórmula	Nº. de Parte	Fórmula	Nº. de Parte
P-350	V8 5.8L	1986-1997							HR7BPP30X	0242236615				
P-400	V8 5.0L	1975-1975	HR9BII33V	0242225665					HR9BPP30X	0242225673				
Ranger	L4 2.3L	2011-2011	HR8KII33V	0242230535			HR8DPP33V	0242230583	HR8DPP30V	0242230561				
		2002-2012	HR8DII33X	0242230524			HR8DPP33X	0242230588	HR8DPP30X	0242230569				
		2002-2009											HR8DCX+	0242229775
	V6 3.0L	2002-2002	HR7KII33V	0242236603			HR7DPP33V	0242236625	HR7DPP30V	0242236658				
Taurus	V6 3.8L	1988-1991							HR8JPP302V	0242230563				
Thunderbird	V6 3.8L	1991-1994	HR8JII33V	0242230555			HR8JPP33V	0242230589	HR8JPP302V	0242230563				
	V6 3.8L Supercargado	1990-1990	HR8JII33V	0242230555			HR8JPP33V	0242230589	HR8JPP302V	0242230563				
	V8 3.9L	2003-2003	FR7KII33X	0242236599			FR7DPP33X	0242236631	FR7DPP30X	0242236616				
	V8 4.6L	1996-1996	HR7KII33V	0242236603										
		1994-1996					HR7DPP33V	0242236625	HR7DPP30V	0242236658				
		1994-1995	HR7DII33V	0242236594									HR8DCX+	0242229775
	V8 5.0L	1991-1993	HR9BII33V	0242225665					HR9BPP30X	0242225673				
Topaz	L4 2.3L	1988-1994	HR8DII33X	0242230524			HR8DPP33X	0242230588	HR8DPP30X	0242230569			HR8DCX+	0242229775
		1984-1987	HR7DII33V	0242236594			HR7DPP33V	0242236625						
Transit	V6 3.7L	2015-2019							HR7NPP30V	0242236672				
Windstar	V6 3.8L	1995-2003	HR8KII33V	0242230535			HR8DPP33V	0242230583	HR8DPP30V	0242230561				

**GEO**









Tracker	L4 1.6L	1994-1994											FR7DCX+	0242235667
		1993-1994							WR8DPP30W	0242230599			WR9DC+	0242225599
		1993-1993											WR8DC+	0242229656

**GMC**

Acadia	V6 3.6L	2009-2009	HR8NII332X	0242230530					HR8NPP302	0242229739				
		2007-2016	HR7NII33X	0242236591			HR7MPP33X	0242236629	HR7MPP30X	0242236617				
Canyon	L5 3.7L	2007-2012	HR8MII33X	0242230611			HR8MPP33X	0242230582	HR8MPP30X	0242230564				
Sierra	V8 5.3L	2014-2020	HR8SII33W	0242230615										
		2007-2018					HR8LPP33U	0242230577	HR8LPP30U	0242230558				
		2007-2013	HR8LII33U	0242230523										
	V8 6.2L	2014-2020	HR8SII33W	0242230615										





 Marca / Modelo	 Motor	 Años	 Doble Iridio		 Iridio		 Doble Platino		 Platino		 Super 4		 Níquel	
			Fórmula	Nº. de Parte	Fórmula	Nº. de Parte	Fórmula	Nº. de Parte	Fórmula	Nº. de Parte	Fórmula	Nº. de Parte	Fórmula	Nº. de Parte
Civic	L4 1.6L	1999-1999	FR7DII33X	0242236596			FR7DPP33X	0242236631	FR7DPP30X	0242236616				
		1997-2000	FR8LII33X	0242230531			FR8LPP33X	0242230580	FR7LPP30X	0242236614	FR78X	0242232502	FR8LCX	0242229576
		1997-2000							FR8LPP30X	0242230560				
		1997-1999	FR7LII33X	0242236592			FR7LPP33X	0242236626					FR7LCX+	0242236542
	L4 1.7L	2003-2003											FR7LCX+	0242236542
		2002-2005									FR78X	0242232502		
	L4 1.8L	2001-2005	FR7LII33X	0242236592			FR7LPP33X	0242236626	FR7LPP30X	0242236614				
		2015-2015	YR7SII3520X*	0242135557*										
	L4 2.0L	2006-2015	FR6LII330X	0242240675			FR6LPP330X	0242240687	FR6LPP300X	0242240683				
		2016-2020	VR6NII352U*	0242140555*										
2007-2011		FR6KII33X	0242240669											
L4 2.4L	2012-2015	YR6SII330X	0242140523											
Crosstour	V6 3.5L	2012-2014	YR6SII330X	0242140523										
CR-V	L4 2.4L	2015-2019	VR6NII352U*	0242140555*										
		2010-2011	YR6SII330X	0242140523										
		2002-2009	FR6LII330X	0242240675			FR6LPP330X	0242240687	FR6LPP300X	0242240683	FR78X	0242232502		
		2002-2006			FR6KI332S	0242240653								
Fit	L4 1.5L	2017-2020	VR7SII350U*	0242135570*										
		2014-2014	FR6LII330X	0242240675										
		2007-2016	FR6LII330V	0242240691										
		2007-2013					FR6LPP330X	0242240687	FR6LPP300X	0242240683				
		2006-2006	FR7LII33X	0242236592			FR7LPP33X	0242236626	FR7LPP30X	0242236614			FR7DCX+	0242235667
HR-V	L4 1.8L	2016-2020	YR7SII3520X*	0242135557*										
Odyssey	V6 3.5L	2011-2020	YR7SII3520X*	0242135557*										
		2008-2009	YR6SII330X	0242140523										
		2005-2010	FR7LII33X	0242236592			FR7LPP33X	0242236626	FR7LPP30X	0242236614				
		2000-2004	FR8LII33X	0242230531			FR8LPP33X	0242230580	FR8LPP30X	0242230560				
Pilot	V6 3.5L	2012-2021	YR7SII3520X*	0242135557*										
		2012-2013	HR8LII33U	0242230523										
		2009-2011	YR6SII330X	0242140523										
		2005-2008	FR7LII33X	0242236592			FR7LPP33X	0242236626	FR7LPP30X	0242236614				
		2003-2004	FR8LII33X	0242230531			FR8LPP33X	0242230580	FR8LPP30X	0242230560				



Marca / Modelo	Motor	Años	Doble Iridio		Iridio		Doble Platino		Platino		Super 4		Níquel	
			Fórmula	Nº. de Parte	Fórmula	Nº. de Parte	Fórmula	Nº. de Parte	Fórmula	Nº. de Parte	Fórmula	Nº. de Parte	Fórmula	Nº. de Parte
Ridgeline	V6 3.5L	2009-2014	YR6SII330X	0242140523										
		2007-2008	FR7LII33X	0242236592			FR7LPP33X	0242236626	FR7LPP30X	0242236614				

## HUMMER

H2	V8 6.0L	2005-2007	HR8LI33U	0242230523			HR8LPP33U	0242230577	HR8LPP30U	0242230558				
	V8 6.2L	2008-2009	HR8LI33U	0242230523			HR8LPP33U	0242230577	HR8LPP30U	0242230558				
H3	L5 3.5L	2006-2006	HR8MII33X	0242230611			HR8MPP33X	0242230582	HR8MPP30X	0242230564				
	L5 3.7L	2007-2010	HR8MII33X	0242230611			HR8MPP33X	0242230582	HR8MPP30X	0242230564				
	V8 5.3L	2008-2009	HR8LI33U	0242230523			HR8LPP33U	0242230577	HR8LPP30U	0242230558				
H3T	L5 3.7L	2010-2010	HR8MII33X	0242230611			HR8MPP33X	0242230582	HR8MPP30X	0242230564				









## HYUNDAI

Accent	L4 1.6L	2018-2019	YR8SII33U	0242129524									YR8SEU	0242129515
Elantra	L4 1.8L	2015-2016	YR7SII33U	0242135548										
	L4 2.0L	2017-2020	YR7SII33U	0242135548										
Grand i10	L4 1.2L	2018-2021	YR7MII33X	0242135554										
Ioniq	L4 1.6L	2018-2019	YR7NII33S	0242135533										
Santa Fe	L4 2.0L	2019-2019	YR7SII33T	0242135556										
	V6 3.3L	2018-2018	YR7SII33U	0242135548										
Santa Fe Sport	L4 2.0L	2017-2018	YR7SII33T	0242135556										
Santa Fe XL	V6 3.3L	2019-2019	YR7SII33U	0242135548										
Sonata	L4 2.0L	2016-2018	YR7SII33T	0242135556										
	L4 2.4L	2015-2018	YR7SII33X	0242135564										
Tucson	L4 2.0L	2016-2020	YR7SII33U	0242135548										
	L4 2.4L	2019-2020	YR7SII33X	0242135564										

## INFINITI

FX35	V6 3.5L	2012-2012	VR6NII35U*	0242140550*										
FX37	V6 3.7L	2013-2013	VR6NII35U*	0242140550*										
FX50	V8 5.0L	2012-2013	VR6NII35U*	0242140550*										
G37	V6 3.7L	2012-2013	VR6NII35U*	0242140550*										
I30	V6 3.0L	1998-2001	FR8KII33X	0242230528			FR8DPP33X	0242230579	FR8DPP30X	0242230557				
		1998-2001	FR7KII33X	0242236599			FR7DPP33X	0242236631	FR7DPP30X	0242236616				











 Marca / Modelo	 Motor	 Años	 Doble Iridio		 Iridio		 Doble Platino		 Platino		 Super 4		 Níquel	
			Fórmula	Nº. de Parte	Fórmula	Nº. de Parte	Fórmula	Nº. de Parte	Fórmula	Nº. de Parte	Fórmula	Nº. de Parte	Fórmula	Nº. de Parte
I35	V6 3.5L	2002-2003	FR8MII33X	0242230533			FR8MPP33X	0242230584	FR8MPP30X	0242230562				
		2002-2003	FR7NII33X	0242236593			FR7MPP33X	0242236630	FR7NPP30X	0242236619				
JX35	V6 3.5L	2013-2013	VR6NII35U*	0242140550*										
M37	V6 3.7L	2012-2013	VR6NII35U*	0242140550*										
M56	V8 5.6L	2012-2013	VR6NII35U*	0242140550*										
Q45	V8 4.1L	1997-2001	FR7KII33X	0242236599			FR7DPP33X	0242236631	FR7DPP30X	0242236616	FR78X	0242232502		
		1997-2001	FR8KII33X	0242230528			FR8DPP33X	0242230579	FR8DPP30X	0242230557				
	V8 4.5L	2002-2006	FR8MII33X	0242230533			FR8MPP33X	0242230584	FR8MPP30X	0242230562				
		2002-2006	FR7NII33X	0242236593			FR7MPP33X	0242236630	FR7NPP30X	0242236619				
		1994-1995	FR8KII33X	0242230528			FR8DPP33X	0242230579	FR8DPP30X	0242230557				
		1994-1995	FR7KII33X	0242236599			FR7DPP33X	0242236631	FR7DPP30X	0242236616				
		1994-1995	FR6KII33X	0242240669			FR6KPP33X+	0242240649						
Q50	V6 3.0L	2017-2017	VR6NII35U*	0242140550*										
	V6 3.5L	2015-2020	VR6NII35U*	0242140550*										
	V6 3.7L	2015-2018	VR6NII35U*	0242140550*										
Q60	V6 3.0L	2017-2017	VR6NII35U*	0242140550*										
	V6 3.7L	2014-2016	VR6NII35U*	0242140550*										
Q70	V6 3.7L	2014-2019	VR6NII35U*	0242140550*										
	V8 5.6L	2014-2019	VR6NII35U*	0242140550*										
QX56	V8 5.6L	2012-2013	VR6NII35U*	0242140550*										
QX60	L4 2.5L	2015-2019	VR6NII35U*	0242140550*										
	V6 3.5L	2014-2019	VR6NII35U*	0242140550*										
QX70	V6 3.7L	2014-2020	VR6NII35U*	0242140550*										
	V8 5.0L	2014-2016	VR6NII35U*	0242140550*										
QX80	V8 5.6L	2014-2020	VR6NII35U*	0242140550*										

**JAGUAR**

F-Pace	V8 5.0L	2019-2019	VR7MII33U	0242135569										
F-Type	V8 5.0L	2014-2019	VR7MII33U	0242135569										





 Marca / Modelo	 Motor	 Años	 Doble Iridio		 Iridio		 Doble Platino		 Platino		 Super 4		 Níquel	
			Fórmula	Nº. de Parte	Fórmula	Nº. de Parte	Fórmula	Nº. de Parte	Fórmula	Nº. de Parte	Fórmula	Nº. de Parte	Fórmula	Nº. de Parte
S-Type	V6 3.0L	2001-2007	HR7DII33V	0242236594			HR7DPP33V	0242236625	HR7DPP30V	0242236658				
	V8 4.0L	2000-2002	FR8DII33X	0242230534			FR7DPP33X	0242236631	FR7DPP30X	0242236616				
		2008-2008					FR8DPP33X	0242230579	FR8DPP30X	0242230557				
	V8 4.2L	2003-2008	FR8DII33X	0242230534										
		2003-2007					FR7DPP33X	0242236631	FR7DPP30X	0242236616				
Super V8	V8 4.2L	2008-2009					FR8DPP33X	0242230579	FR8DPP30X	0242230557				
		2005-2009	FR8DII33X	0242230534										
		2005-2007					FR7DPP33X	0242236631	FR7DPP30X	0242236616				
Vanden Plas	V8 4.0L	2001-2001	FR7KII33X	0242236599										
		1998-2003	FR8DII33X	0242230534					FR7DPP30X	0242236616				
	V8 4.2L	2008-2009					FR8DPP33X	0242230579	FR8DPP30X	0242230557				
		2004-2009	FR8DII33X	0242230534										
	2004-2007					FR7DPP33X	0242236631	FR7DPP30X	0242236616					
XE	L4 2.0L	2016-2017	HR7NII332S	0242236675										
XF	L4 2.0L	2013-2015	HR7NII332S	0242236675										
	V8 4.2L	2009-2010	FR8DII33X	0242230534			FR8DPP33X	0242230579	FR8DPP30X	0242230557				
	V8 4.2L Supercargado	2009-2009			FR6KI332S	0242240653								
	V8 5.0L	2010-2012	VR7MII33U	0242135569										
XFR	V8 5.0L	2010-2015	VR7MII33U	0242135569										
XJ	V8 5.0L	2011-2015	VR7MII33U	0242135569										
XJ8	V8 4.0L	2003-2003					FR7DPP33X	0242236631						
		2002-2003										FR8DCX+	0242229660	
		1999-2003	FR8DII33X	0242230534					FR7DPP30X	0242236616				
	V8 4.2L	2008-2009					FR8DPP33X	0242230579	FR8DPP30X	0242230557				
		2005-2009	FR8DII33X	0242230534										
	2005-2007					FR7DPP33X	0242236631	FR7DPP30X	0242236616					
XJR	V8 4.0L	2002-2003	FR8DII33X	0242230534			FR7DPP33X	0242236631						
		1999-2003							FR7DPP30X	0242236616				
		1999-2001	FR7KII33X	0242236599										
	V8 4.2L	2008-2009							FR8DPP30X	0242230557				
		2006-2009	FR8DII33X	0242230534										
	2006-2007							FR7DPP30X	0242236616					

Marca / Modelo	Motor	Años	Doble Iridio		Iridio		Doble Platino		Platino		Super 4		Níquel	
			Fórmula	Nº. de Parte	Fórmula	Nº. de Parte	Fórmula	Nº. de Parte	Fórmula	Nº. de Parte	Fórmula	Nº. de Parte	Fórmula	Nº. de Parte
XK	V8 4.2L	2007-2007	FR8DII33X	0242230534			FR7KPP33U+	0242236544	FR7DPP30X	0242236616				
	V8 5.0L	2010-2010	VR7MII33U	0242135569										
XK8	V8 4.0L	1998-2002	FR8DII33X	0242230534			FR7DPP33X	0242236631	FR7DPP30X	0242236616				
	V8 4.2L	2003-2004	FR8DII33X	0242230534			FR7DPP33X	0242236631	FR7DPP30X	0242236616				
XKR	V8 4.0L	2000-2002	FR7KII33X	0242236599			FR7DPP33X	0242236631	FR7DPP30X	0242236616				
		2008-2009					FR7KPP33U+	0242236544						
	V8 4.2L	2005-2009	FR8DII33X	0242230534										
		2005-2006				FR6KI332S	0242240653	FR7DPP33X	0242236631	FR7DPP30X	0242236616			
V8 5.0L	2010-2013	VR7MII33U	0242135569											
XKR-S	V8 5.0L	2014-2014	VR7MII33U	0242135569										
X-Type	V6 2.5L	2002-2005	HR7DII33V	0242236594			HR7DPP33V	0242236625	HR7DPP30V	0242236658				
	V6 3.0L	2002-2008	HR7DII33V	0242236594			HR7DPP33V	0242236625	HR7DPP30V	0242236658				

**JEEP**

Cherokee	L4 2.4L	2014-2017	FR8SII332X	0242230618										
	L6 4.0L	1993-2001	FR8VII33U	0242230532			FR8VPP33U	0242230585	FR8VPP30U	0242230565				
	V6 3.2L	2014-2019	YR7SII3320U	0242135574	YR7SII302U	0242135555								
CJ5	L6 4.2L	1975-1977											WR9DC+	0242225599
Commander	V8 4.7L	2010-2010			FR8TI332	0242229764							FR8TE2	0242229765
		2006-2007	FR8KII332X	0242230556					FR8LPP302X	0242230570			FR8LCX	0242229576
		2009-2010											FR8SEX	0242230624
		2009-2009	FR8SII33X	0242230571			FR8SPP33X	0242230604	FR8SPP30X	0242230576				
Compass	L4 2.4L	2006-2008	HR9SII330X	0242225664			HR9SPP330X	0242225680	HR9SPP300X	0242225672			HR9SE0X	0242225668
		2018-2019	FR8SII332X	0242230618										
Grand Cherokee	L6 4.0L	2007-2017	FR8LII33X	0242230531			FR8LPP33X	0242230580	FR8LPP30X	0242230560			FR8LCX	0242229576
		1993-2004	FR8VII33U	0242230532			FR8VPP33U	0242230585	FR8VPP30U	0242230565				
	V6 3.6L	2017-2017	FR8SII33X	0242230571			FR8SPP33X	0242230604	FR8SPP30X	0242230576				
		2011-2019	YR7SII3320U	0242135574										
	V6 3.7L	2011-2016			YR7SII302U	0242135555								
		2005-2010	FR7LII33X	0242236592					FR8LPP302X	0242230570	FR78X	0242232502	FR7LCX+	0242236542
	V8 4.7L	2008-2009			FR8TI332	0242229764							FR8TE2	0242229765
2001-2009										FR78X	0242232502			
1999-2009	FR8KII332X	0242230556						FR8LPP302X	0242230570					





 Marca / Modelo	 Motor	 Años	 Doble Iridio		 Iridio		 Doble Platino		 Platino		 Super 4		 Níquel	
			Fórmula	Nº. de Parte	Fórmula	Nº. de Parte	Fórmula	Nº. de Parte	Fórmula	Nº. de Parte	Fórmula	Nº. de Parte	Fórmula	Nº. de Parte
Rio	L4 1.6L	2020-2020											YR8SEU	0242129515
		2016-2020	YR8SII33U	0242129524										
Sedona	V6 3.3L	2019-2019	YR7SII33X	0242135564										
Sorento	L4 2.4L	2020-2020	YR7SII33X	0242135564										
		2016-2019	YR7SII33U	0242135548										
	V6 3.3L	2020-2020	YR7SII33X	0242135564										
		2016-2019	YR7SII33U	0242135548										
Soul	L4 1.6L	2016-2020	YR8SII33U	0242129524										
	L4 2.0L	2016-2020	YR7SII33U	0242135548										
Sportage	L4 2.0L	2016-2019	YR7SII33T	0242135556										
	L4 2.4L	2017-2020	YR7SII33X	0242135564										
	V6 3.3L	2016-2016	YR7SII33U	0242135548										

**LAND ROVER**

Discovery	V8 4.0L	1999-2002	FR8DII33X	0242230534			FR8DPP33X	0242230579	FR8DPP30X	0242230557				
		1998-2002									WR78	0242232504		
		1998-1999											WR8DC+	0242229656
	V8 4.6L	2003-2004	FR8DII33X	0242230534			FR8DPP33X	0242230579	FR8DPP30X	0242230557				
		2003-2003									WR78	0242232504	WR7DC+	0242235663
Discovery Sport	L4 2.0L	2015-2017	HR7NII332S	0242236675										
Freelander	L4 1.8L	1999-2001					FR7KPP33U+	0242236544						
	V6 2.5L	2002-2006	FR7DII33X	0242236596	FR6KI332S	0242240653	FR7KPP33U+	0242236544	FR7DPP30X	0242236616				
LR2	L4 2.0L	2013-2015	HR7NII332S	0242236675										
	L6 3.2L	2008-2012			FR7NI33	0242236528								
LR3	V8 4.4L	2007-2008					FR8DPP33X	0242230579	FR8DPP30X	0242230557				
		2005-2008	FR8DII33X	0242230534										
LR4	V8 5.0L	2010-2013	VR7MII33U	0242135569										
Range Rover	V8 4.2L	2007-2009							FR8DPP30X	0242230557				
		2006-2009	FR8DII33X	0242230534			FR8DPP33X	0242230579						
	V8 4.4L	2007-2009							FR8DPP30X	0242230557				
		2006-2009	FR8DII33X	0242230534			FR8DPP33X	0242230579						
		2003-2005						FGR7DQP+	0242236562	FR78X	0242232502	FR7LDC+	0242235668	





Marca / Modelo	Motor	Años	Doble Iridio		Iridio		Doble Platino		Platino		Super 4		Níquel	
			Fórmula	Nº. de Parte	Fórmula	Nº. de Parte	Fórmula	Nº. de Parte	Fórmula	Nº. de Parte	Fórmula	Nº. de Parte	Fórmula	Nº. de Parte
Range Rover	V8 4.6L	2000-2001					FR8DPP33X	0242230579						
		1997-2001											WR8DC+	0242229656
	V8 5.0L	2010-2017	VR7MII33U	0242135569										
	V8 5.0L Supercargado	2013-2013	VR7MII33U	0242135569										
Range Rover Evoque	L4 2.0L	2012-2017	HR7NII332S	0242236675										
Range Rover Sport	V8 4.2L	2007-2009					FR8DPP33X	0242230579	FR8DPP30X	0242230557				
		2006-2009	FR8DII33X	0242230534										
		2006-2006							FGR7DQP+	0242236562				
	V8 4.4L	2007-2009					FR8DPP33X	0242230579	FR8DPP30X	0242230557				
		2006-2009	FR8DII33X	0242230534										
		2006-2006							FGR7DQP+	0242236562				
V8 5.0L	2010-2017	VR7MII33U	0242135569											

## LINCOLN

Aviator	V8 4.6L	2003-2005	HR7KII33V	0242236603			HR7DPP33Y	0242236628	HR7DPP30Y	0242236613				
Continental	V6 3.0L	2018-2019	HR7NII332S	0242236675										
		1998-1999					HR7DPP33Y	0242236628	HR7DPP30Y	0242236613				
	V8 4.6L	1997-1999	HR7KII33V	0242236603										
		1997-1997					HR7DPP33V	0242236625	HR7DPP30V	0242236658				
LS	V6 3.0L	2004-2005	HR7DII33V	0242236594			HR7DPP33V	0242236625	HR7DPP30V	0242236658				
		2000-2006	FR7KII33X	0242236599			FR7DPP33X	0242236631	FR7DPP30X	0242236616				
	V8 3.9L	2000-2002									FR78X	0242232502		
Mark LT	V8 5.0L	2011-2014	HR7NII33X	0242236591			HR7MPP33X	0242236629	HR7MPP30X	0242236617				
Mark VIII	V8 4.6L	1996-1996	HR7KII33V	0242236603										
		1995-1996					HR7DPP33V	0242236625	HR7DPP30V	0242236658				
		1995-1995	HR7DII33V	0242236594									HR8DCX+	0242229775
MKC	L4 2.0L	2018-2019				HR7MII30T	0242236678							
	L4 2.3L	2015-2019				HR7MII30T	0242236678							
MKS	V6 3.7L	2009-2011	HR7NII33X	0242236591			HR7MPP33X	0242236629	HR7NPP30V	0242236672				
MKX	V6 2.7L	2016-2018	HR7NII332S	0242236675										
	V6 3.5L	2007-2010	HR7NII33X	0242236591			HR7MPP33X	0242236629	HR7NPP30V	0242236672				

Marca / Modelo	Motor	Años	Doble Iridio		Iridio		Doble Platino		Platino		Super 4		Níquel	
			Fórmula	Nº. de Parte	Fórmula	Nº. de Parte	Fórmula	Nº. de Parte	Fórmula	Nº. de Parte	Fórmula	Nº. de Parte	Fórmula	Nº. de Parte
MXK	V6 3.7L	2011-2015							HR7NPP30V	0242236672				
MKZ	L4 2.0L	2018-2019	HR8MII33V	0242230612										
		2013-2019			HR7MII30T	0242236678								
	V6 3.0L	2018-2019	HR7NII332S	0242236675										
	V6 3.5L	2007-2012	HR7NII33X	0242236591			HR7MPP33X	0242236629	HR7NPP30V	0242236672				
Nautilus	V6 2.7L	2013-2016							HR7NPP30V	0242236672				
		2019-2019	HR7NII332S	0242236675										
Navigator	V8 5.4L	2008-2011	AR7TII330U	0242135565										
		2001-2014	HR7DII33V	0242236594										
		2001-2004					HR7DPP33V	0242236625	HR7DPP30V	0242236658				
		1998-2000	HR7KII33V	0242236603			HR7DPP33Y	0242236628	HR7DPP30Y	0242236613				
Town Car	V8 4.6L	1995-1997	HR7KII33V	0242236603										
		1991-2007	HR7DII33V	0242236594			HR7DPP33V	0242236625	HR7DPP30V	0242236658				
		1991-1994											HR8DCX+	0242229775
Zephyr	V6 3.0L	2006-2006	HR7KII33V	0242236603			HR7DPP33Y	0242236628	HR7DPP30Y	0242236613				

**MAYBACH**

57	V12 5.5L	2003-2006			FR7KI332S	0242236571								
	V12 6.0L	2006-2009			FR7KI332S	0242236571								
62	V12 5.5L	2003-2009			FR7KI332S	0242236571								

**MAZDA**

2	L4 1.5L	2015-2018	VR7NII33X	0242135529										
		2012-2014	FR7DII33X	0242236596			FR7DPP33X	0242236631	FR7DPP30X	0242236616				
3	L4 2.0L	2015-2018	VR7NII33X	0242135529										
		2012-2014	VR6NII35T*	0242140536*										
		2006-2012	HR8MII33V	0242230612					HR8NPP302X	0242230573				
	L4 2.3L	2006-2009	HR8MII33V	0242230612					HR8NPP302X	0242230573				
	L4 2.3L Turbo	2008-2008	HR7NII332S	0242236675										
		2015-2020	VR7NII33X	0242135529										
2014-2014		VR6NII35T*	0242140536*											
L4 2.5L	2010-2013	HR8MII33V	0242230612					HR8NPP302X	0242230573					



M













Marca / Modelo	Motor	Años	Doble Iridio		Iridio		Doble Platino		Platino		Super 4		Níquel	
			Fórmula	Nº. de Parte	Fórmula	Nº. de Parte	Fórmula	Nº. de Parte	Fórmula	Nº. de Parte	Fórmula	Nº. de Parte	Fórmula	Nº. de Parte
B200	L4 2.0L	2011-2011	FR8DII33X	0242230534			FR8DPP33X	0242230579	FR8DPP30X	0242230557				
		2006-2011											FQR8DE	0242229724
		2006-2009					FR7KPP33U+	0242236544						
C180	L4 1.6L	2013-2019	VA6SIP80	0241140537										
	L4 1.8L	2011-2012					YR6NPP332	0242140512						
C200	L4 1.5L	2019-2019	VA6SIP80	0241140537										
	L4 1.8L	2011-2014					YR6NPP332	0242140512						
	L4 1.8L Turbo	2010-2010					YR6NPP332	0242140512						
	L4 2.0L	2001-2002	FR7KII33X	0242236599	FR6KI332S	0242240653	FR7KPP33U+	0242236544	FR7DPP30X	0242236616				
C220	L4 2.2L	1995-1997							FR8DPP30T	0242230572			F8DC4	0241229713
C230	L4 1.8L	2004-2005					FR6MPP332	0242240619						
		1999-2000							FR7DPP30T	0242236618			FR7KTC	0242235766
		1997-1997							FR8DPP30T	0242230572			F8DC4	0241229713
	1996-1998											FR6DC+	0242240593	
	L4 2.3L Supercargado	1997-1997										FR6DC+	0242240593	
C240	V6 2.6L	2001-2002	FR8DII33X	0242230534			FR8DPP33+	0242230500	FR8DPP30X	0242230557				
C250	L4 1.8L	2012-2015					YR6NPP332	0242140512						
C280	L6 2.8L	1995-1997							FR8DPP30T	0242230572			F8DC4	0241229713
		1999-2000	FR8DII33X	0242230534			FR8DPP33+	0242230500	FR8DPP30X	0242230557				
	V6 3.0L	2009-2009					YR6NPP332	0242140512						
	V6 3.0L	2006-2008					YR7MPP33	0242135509						
C300	L4 2.0L	2019-2020	VA6SIP80	0241140537										
	V6 3.0L	2010-2011					YR7MPP33	0242135509						
C32 AMG	V6 3.2L	2002-2004	FR7KII33X	0242236599			FR7KPP33U+	0242236544	FR7DPP30X	0242236616				
C320	V6 3.2L	2001-2005	FR8DII33X	0242230534			FR8DPP33+	0242230500	FR8DPP30X	0242230557				
C350	V6 3.5L	2013-2014	ZR6SII3320	0242140521										
		2006-2009					YR7MPP33	0242135509						
C36 AMG	L6 3.6L	1996-1997							FR8DPP30T	0242230572			F8DC4	0241229713
C43 AMG	V6 3.0L	2018-2019	V6SII3328	0241140522										
		2017-2017	VA6SIP80	0241140537										
	V8 4.3L	1998-2000	FR8DII33X	0242230534			FR8DPP33+	0242230500	FR8DPP30X	0242230557				
C450 AMG	V6 3.0L	2016-2016	VA6SIP80	0241140537										



M



 Marca / Modelo	 Motor	 Años	 Doble Iridio		 Iridio		 Doble Platino		 Platino		 Super 4		 Níquel	
			Fórmula	Nº. de Parte	Fórmula	Nº. de Parte	Fórmula	Nº. de Parte	Fórmula	Nº. de Parte	Fórmula	Nº. de Parte	Fórmula	Nº. de Parte
C55 AMG	V8 5.4L	2005-2006	FR7KII33X	0242236599			FR7KPP33U+	0242236544	FR7DPP30X	0242236616				
C63 AMG	V8 4.0L	2018-2019	VA6SIP80	0241140537										
		2016-2017	V6SII3328	0241140522										
C63 AMG S	V8 4.0L	2018-2019	VA6SIP80	0241140537										
		2016-2017	V6SII3328	0241140522										
CL500	V8 5.0L	1997-2006	FR8DII33X	0242230534			FR8DPP33+	0242230500	FR8DPP30X	0242230557				
		1997-1998											F8DC4	0241229713
		2007-2012					YR7MPP33	0242135509						
CL55 AMG	V8 5.5L	2007-2008					YR6NPP332	0242140512						
		2003-2004					FR6MPP332	0242240619						
CL600	V12 5.5L	2003-2013	FR7KII332S	0242236668	FR7KI332S	0242236571								
	V12 5.8L	2001-2002	FR8DII33X	0242230534			FR7KPP33U+	0242236544	FR8DPP30X	0242230557				
	V12 6.0L	1998-1999	FR8DII33X	0242230534			FR7KPP33U+	0242236544					FR8DC+	0242229659
CL65 AMG	V12 6.0L	2013-2013	FR7KII332S	0242236668										
		2005-2013			FR7KI332S	0242236571	FR7KPP33U+	0242236544						
CLA45 AMG	L4 2.0L	2014-2019	VA6SIP80	0241140537										
CLK280	V6 3.0L	2007-2009					YR7MPP33	0242135509						
CLK320	V6 3.2L	1998-2005	FR8DII33X	0242230534			FR8DPP33+	0242230500	FR8DPP30X	0242230557				
CLK350	V6 3.5L	2006-2009					YR7MPP33	0242135509						
CLK430	V8 4.3L	1999-2003	FR8DII33X	0242230534			FR8DPP33+	0242230500	FR8DPP30X	0242230557				
CLK500	V8 5.0L	2003-2006	FR8DII33X	0242230534			FR8DPP33+	0242230500	FR8DPP30X	0242230557				
	V8 5.5L	2007-2009					YR6NPP332	0242140512						
CLK55 AMG	V8 5.4L	2003-2004	FR7KII33X	0242236599			FR7KPP33U+	0242236544	FR7DPP30X	0242236616				
CLS350	V6 3.5L	2010-2014	ZR6SII3320	0242140521										
	V6 3.5L	2007-2009					YR7MPP33	0242135509						
CLS500	V8 5.0L	2005-2006					FR8DPP33+	0242230500						
		2007-2011					YR6NPP332	0242140512						
CLS55 AMG	V8 5.4L	2006-2006					FR6MPP332	0242240619						
CLS63 AMG	V8 5.5L	2012-2014	ZR6SII3320	0242140521										
CLS63 AMG S	V8 5.5L	2017-2018	ZR6SII3320	0242140521										
E200	L4 1.8L	2012-2013					YR6NPP332	0242140512						
E250	L4 1.8L	2011-2013					YR6NPP332	0242140512						
E280	V6 2.8L	1999-1999					FR8DPP33+	0242230500						







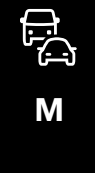

Marca / Modelo	Motor	Años	Doble Iridio		Iridio		Doble Platino		Platino		Super 4		Níquel	
			Fórmula	Nº. de Parte	Fórmula	Nº. de Parte	Fórmula	Nº. de Parte	Fórmula	Nº. de Parte	Fórmula	Nº. de Parte	Fórmula	Nº. de Parte
E280	V6 3.0L	2007-2009					YR7MPP33	0242135509						
E300	V6 3.0L	2010-2011					YR7MPP33	0242135509						
E320	L6 3.2L	1996-1996							FR8DPP30T	0242230572			F8DC4	0241229713
	V6 3.2L	1998-2005	FR8DII33X	0242230534			FR8DPP33+	0242230500	FR8DPP30X	0242230557				
E350	V6 3.5L	2013-2013	ZR6SII3320	0242140521										
		2006-2011					YR7MPP33	0242135509						
E400	V6 3.0L	2015-2017	VA6SIP80	0241140537										
E420	V8 4.2L	1994-1998							FR8DPP30T	0242230572			F8DC4	0241229713
E430	V8 4.3L	1998-2001	FR8DII33X	0242230534			FR8DPP33+	0242230500	FR8DPP30X	0242230557				
E450	V6 3.0L	2019-2019	V6SII3328	0241140522										
E500	V8 5.0L	2003-2006	FR8DII33X	0242230534			FR8DPP33+	0242230500	FR8DPP30X	0242230557				
	V8 5.5L	2016-2016	ZR6SII3320	0242140521										
E55 AMG	V8 5.4L	2007-2011					YR6NPP332	0242140512						
		2003-2006					FR6MPP332	0242240619						
	2002-2006	FR8DII33X	0242230534					FR8DPP30X	0242230557					
	2002-2002					FR8DPP33+	0242230500							
V8 5.5L	1998-2001	FR8DII33X	0242230534			FR8DPP33+	0242230500	FR8DPP30X	0242230557					
E63 AMG	V8 4.0L	2020-2020	VA6SIP80	0241140537										
E63 AMG S	V8 4.0L	2019-2019	VA6SIP80	0241140537										
G500	V8 5.0L	2002-2008	FR8DII33X	0242230534					FR8DPP30X	0242230557				
		1999-2008					FR8DPP33+	0242230500						
	V8 5.5L	2009-2014					YR7MPP33	0242135509						
	2009-2014						YR6NPP332	0242140512						
G55 AMG	V8 5.4L	2009-2011					FR6MPP332	0242240619						
G63 AMG	V8 4.0L	2019-2019	VA6SIP80	0241140537										
G65 AMG	V12 6.0L	2016-2018	FR7KII332S	0242236668										
		2014-2018			FR7KI332S	0242236571								
GL450	V8 4.7L	2007-2009					YR6NPP332	0242140512						
GL500	V8 5.5L	2008-2012					YR7MPP33	0242135509						
		2008-2012					YR6NPP332	0242140512						
GLA180	L4 1.6L	2016-2018	VA6SIP80	0241140537										
GLA200	L4 1.6L	2014-2019	VA6SIP80	0241140537										
	L4 2.0L	2014-2015	VA6SIP80	0241140537										



M



Marca / Modelo	Motor	Años	Doble Iridio		Iridio		Doble Platino		Platino		Super 4		Níquel	
			Fórmula	Nº. de Parte	Fórmula	Nº. de Parte	Fórmula	Nº. de Parte	Fórmula	Nº. de Parte	Fórmula	Nº. de Parte	Fórmula	Nº. de Parte
GLA45 AMG	L4 2.0L	2018-2019	V6SII3328	0241140522										
GLC43 AMG	V6 3.0L	2020-2020	V6SII3328	0241140522										
GLE400	V6 3.0L	2019-2019	V6SII3328	0241140522										
		2017-2017	VA6SIP80	0241140537										
GLE450 AMG	V6 3.0L	2016-2016	VA6SIP80	0241140537										
GLK280	V6 3.0L	2009-2009					YR7MPP33	0242135509						
GLK300	V6 3.0L	2010-2012					YR7MPP33	0242135509						
GLK350	V6 3.5L	2013-2015					YR7MPP33	0242135509						
Maybach S600	V12 6.0L	2016-2017	FR7KII332S	0242236668	FR7KI332S	0242236571								
Maybach S650	V12 6.0L	2018-2019	FR7KII332S	0242236668	FR7KI332S	0242236571								
ML320	V6 3.2L	1998-2002	FR8DII33X	0242230534			FR8DPP33+	0242230500	FR8DPP30X	0242230557				
ML350	V6 3.5L	2012-2015	FR8KII33X	0242230528			FR8DPP33X	0242230579	FR8DPP30X	0242230557				
		2006-2011					YR7MPP33	0242135509						
	V6 3.7L	2003-2005	FR8DII33X	0242230534			FR8DPP33+	0242230500	FR8DPP30X	0242230557				
ML430	V8 4.3L	1999-2001	FR8DII33X	0242230534			FR8DPP33+	0242230500	FR8DPP30X	0242230557				
ML500	V8 4.7L	2012-2015	FR8KII33X	0242230528			FR8DPP33X	0242230579	FR8DPP30X	0242230557				
	V8 5.0L	2002-2007	FR8DII33X	0242230534			FR8DPP33+	0242230500	FR8DPP30X	0242230557				
	V8 5.5L	2008-2011					YR7MPP33	0242135509						
		2008-2011					YR6NPP332	0242140512						
ML55 AMG	V8 5.4L	2002-2003	FR8DII33X	0242230534			FR8DPP33+	0242230500	FR8DPP30X	0242230557				
	V8 5.5L	2001-2001	FR8DII33X	0242230534			FR8DPP33+	0242230500	FR8DPP30X	0242230557				
R350	V6 3.5L	2008-2012					YR7MPP33	0242135509						
R500	V8 5.0L	2006-2007	FR8DII33X	0242230534			FR8DPP33+	0242230500	FR8DPP30X	0242230557				
S420	V8 4.2L	1998-1998	FR8DII33X	0242230534			FR8DPP33+	0242230500	FR8DPP30X	0242230557				
		1996-1997							FR8DPP30T	0242230572			F8DC4	0241229713
S430	V8 4.3L	2000-2005	FR8DII33X	0242230534					FR8DPP30X	0242230557				
		1999-2005						FR8DPP33+	0242230500					
S500	V8 4.7L	2017-2017	ZR6SII3320	0242140521										
	V8 5.0L	2000-2006	FR8DII33X	0242230534					FR8DPP30X	0242230557				
		1998-2006						FR8DPP33+	0242230500					
		1996-1997								FR8DPP30T	0242230572			F8DC4
	V8 5.5L	2007-2011						YR7MPP33	0242135509					
2007-2011							YR6NPP332	0242140512						

 Marca / Modelo	 Motor	 Años	 Doble Iridio		 Iridio		 Doble Platino		 Platino		 Super 4		 Níquel	
			Fórmula	Nº. de Parte	Fórmula	Nº. de Parte	Fórmula	Nº. de Parte	Fórmula	Nº. de Parte	Fórmula	Nº. de Parte	Fórmula	Nº. de Parte
S500L	V8 4.7L	2017-2017	ZR6SII3320	0242140521										
S55 AMG	V8 5.4L	2003-2005					FR6MPP332	0242240619						
S600	V12 5.5L	2003-2009	FR7KII332S	0242236668	FR7KI332S	0242236571	FR7KPP33U+	0242236544						
	V12 5.8L	2001-2002	FR8DII33X	0242230534			FR7KPP33U+	0242236544						
	V12 6.0L	2015-2015			FR7KI332S	0242236571								
		1996-1998						FR8DPP33+	0242230500					
	1996-1997								FR8DPP30T	0242230572		F8DC4	0241229713	
S600L	V12 6.0L	1995-1995					FR8DPP33+	0242230500	FR8DPP30T	0242230572		F8DC4	0241229713	
S63 AMG	V8 4.0L	2019-2019	VA6SIP80	0241140537										
S63L AMG	V8 5.5L	2017-2017	ZR6SII3320	0242140521										
S65 AMG	V12 6.0L	2007-2009					FR7KPP33U+	0242236544						
		2005-2019	FR7KII332S	0242236668	FR7KI332S	0242236571								
S65L AMG	V12 6.0L	2017-2017	FR7KII332S	0242236668	FR7KI332S	0242236571								
SL320	L6 3.2L	1996-1997							FR8DPP30T	0242230572		F8DC4	0241229713	
SL500	V8 4.7L	2015-2019	ZR6SII3320	0242140521										
		2013-2014	FR8KII33X	0242230528			FR8DPP33X	0242230579	FR8DPP30X	0242230557				
	V8 5.0L	2004-2006	FR8DII33X	0242230534					FR8DPP30X	0242230557				
		1998-2006					FR8DPP33+	0242230500						
		1996-1998							FR8DPP30T	0242230572		F8DC4	0241229713	
	V8 5.5L	2007-2012					YR7MPP33	0242135509						
2007-2012						YR6NPP332	0242140512							
SL55 AMG	V8 5.4L	2003-2007					FR6MPP332	0242240619						
SL60 AMG	V8 6.0L	1998-1998					FR8DPP33+	0242230500						
		1997-1997							FR8DPP30T	0242230572		F8DC4	0241229713	
SL600	V12 5.5L	2003-2012	FR7KII332S	0242236668	FR7KI332S	0242236571	FR7KPP33U+	0242236544						
		1998-2002					FR8DPP33+	0242230500						
	V12 6.0L	1998-1998	FR8DII33X	0242230534					FR8DPP30X	0242230557				
		1996-2002							FR8DPP30T	0242230572		F8DC4	0241229713	
SL65 AMG	V12 6.0L	2005-2017	FR7KII332S	0242236668	FR7KI332S	0242236571	FR7KPP33U+	0242236544						
SLC43 AMG	V6 3.0L	2017-2019	VA6SIP80	0241140537										
SLK200	L4 1.8L	2012-2015					YR6NPP332	0242140512						
		2008-2011					YR7MPP33	0242135509						
	L4 2.0L	2003-2004	FR7KII33X	0242236599			FR7KPP33U+	0242236544	FR7DPP30X	0242236616				



M

Marca / Modelo	Motor	Años	Doble Iridio		Iridio		Doble Platino		Platino		Super 4		Níquel	
			Fórmula	Nº. de Parte	Fórmula	Nº. de Parte	Fórmula	Nº. de Parte	Fórmula	Nº. de Parte	Fórmula	Nº. de Parte	Fórmula	Nº. de Parte
SLK230	L4 2.3L	2001-2004							FR7DPP30X	0242236616				
		2000-2004	FR7KII33X	0242236599			FR7KPP33U+	0242236544						
		1997-2000							FR7DPP30T	0242236618			FR7KTC	0242235766
SLK32 AMG	V6 3.2L	2002-2004	FR7KII33X	0242236599			FR7KPP33U+	0242236544	FR7DPP30X	0242236616				
SLK320	V6 3.2L	2001-2004	FR8DII33X	0242230534			FR8DPP33+	0242230500	FR8DPP30X	0242230507				
SLK350	V6 3.5L	2005-2013					YR7MPP33	0242135509						
SLK55 AMG	V8 5.5L	2013-2016					FR7DPP33X	0242236631						
		2006-2011					FR7KPP33U+	0242236544						
		2005-2016	FR7KII33X	0242236599					FR7DPP30X	0242236616				
		2005-2005					FR8DPP33+	0242230500						
SLR McLaren	V8 5.4L	2007-2008					FR6MPP332	0242240619						

## MERCURY

Mariner	V6 3.0L	2009-2011	HR8KII33V	0242230535										
		2009-2009					HR8DPP33V	0242230583	HR8DPP30V	0242230561				
		2008-2008	HR7DII33V	0242236594										
		2005-2008					HR7DPP33V	0242236625	HR7DPP30V	0242236658				
		2005-2007	HR7KII33V	0242236603										
Milan	V6 3.0L	2007-2008	HR7KII33V	0242236603			HR7DPP33Y	0242236628	HR7DPP30Y	0242236613				
Montego	V6 3.0L	2005-2007	HR7KII33V	0242236603			HR7DPP33Y	0242236628	HR7DPP30Y	0242236613				
Sable	V6 3.0L	2002-2004	HR7KII33V	0242236603			HR7DPP33V	0242236625	HR7DPP30V	0242236658				

## MG

TF	L4 1.8L	2003-2005					FR7KPP33U+	0242236544						
ZR	L4 1.8L	2004-2005					FR7KPP33U+	0242236544						

## MINI

Cooper	L3 1.5L	2014-2019					ZR5SPP3320	0242145555						
	L4 1.6L	2012-2016			ZR5SI332	0242145537								
		2010-2015							ZR6SPP302	0242140535				
		2009-2012			ZR7SI332S	0242135518								
		2007-2010			ZQR8SI302	0242129512								
		2005-2006											FR6DC+	0242240593

Marca / Modelo	Motor	Años	Doble Iridio		Iridio		Doble Platino		Platino		Super 4		Níquel	
			Fórmula	Nº. de Parte	Fórmula	Nº. de Parte	Fórmula	Nº. de Parte	Fórmula	Nº. de Parte	Fórmula	Nº. de Parte	Fórmula	Nº. de Parte
Cooper	L4 1.6L	2003-2008											FR7DC+	0242235666
		2002-2008							FGR7DQP+	0242236562				
		2002-2006									FR78X	0242232502		
	L4 1.6L Supercargado	2004-2005									FR78X	0242232502		
		2004-2004											FR7DC+	0242235666
	L4 1.6L Turbo	2012-2012			ZR5SI332	0242145537								
		2007-2012			ZR7SI332S	0242135518								
2007-2007								FGR7DQP+	0242236562					
L4 2.0L	2014-2019					ZR5SPP3320	0242145555							
Cooper Clubman	L3 1.5L	2018-2019					ZR5SPP3320	0242145555						
	L4 2.0L	2017-2019					ZR5SPP3320	0242145555						
Cooper Countryman	L3 1.5L	2018-2019					ZR5SPP3320	0242145555						
	L4 1.6L	2011-2015			ZR5SI332	0242145537								
	L4 2.0L	2018-2019					ZR5SPP3320	0242145555						



**MITSUBISHI**

ASX	L4 2.0L	2013-2015			FR6KI332S	0242240653								
Eclipse	V6 3.0L	2004-2005			FR6KI332S	0242240653			FR8DPP30T	0242230572				
		2003-2005					FR8DPP33X	0242230579						
	2003-2003	FR8KII33X	0242230528				FR7KPP33+	0242236564	FR8DPP30X	0242230557				
	V6 3.8L	2008-2012											FR8DCX+	0242229660
		2006-2012			FR6KI332S	0242240653								
Endeavor	V6 3.8L	2009-2011										FR8DCX+	0242229660	
		2004-2011	FR7KII33X	0242236599	FR6KI332S	0242240653	FR7DPP33X	0242236631	FR7DPP30T	0242236618				
Galant	L4 2.4L	2004-2009			FR7SI332	0242236655								
	V6 3.0L	2003-2003	FR8KII33X	0242230528			FR8DPP33X	0242230579	FR8DPP30X	0242230557				
	V6 3.8L	2004-2009	FR7KII33X	0242236599	FR6KI332S	0242240653	FR7DPP33X	0242236631	FR7DPP30T	0242236618				
L200	L4 2.4L	2010-2016			FR6KI332S	0242240653			FR7DPP30X	0242236616			FR7DCX+	0242235667
	L4 2.4L	2008-2021									FR78X	0242232502	FR8DCX+	0242229660
Lancer	L4 2.0L	2011-2016	FR7DII35X*	0242236642*										
		2008-2016			FR6KI332S	0242240653								
		2006-2006	FR6NII332S	0242240715										
		2005-2007									FR78X	0242232502		



Marca / Modelo	Motor	Años	Doble Iridio		Iridio		Doble Platino		Platino		Super 4		Níquel		
			Fórmula	Nº. de Parte	Fórmula	Nº. de Parte	Fórmula	Nº. de Parte	Fórmula	Nº. de Parte	Fórmula	Nº. de Parte	Fórmula	Nº. de Parte	
Lancer	L4 2.0L	2004-2007	FR8DII33X	0242230534			FR8DPP33X	0242230579	FR8DPP30X	0242230557			FR8DCX+	0242229660	
		2004-2007	FR7DII33X	0242236596			FR7DPP33X	0242236631	FR7DPP30X	0242236616			FR7DCX+	0242235667	
		2004-2004			WR7KI33S	0242236576									
	L4 2.4L	2011-2016	FR7DII35X*	0242236642*											
		2005-2006	FR7NII33X	0242236593	FR7SI332	0242236655	FR7MPP33X	0242236630	FR7NPP30X	0242236619					
Mirage	L3 1.2L	2015-2020			FR7SI30	0242235769									
Mirage G4	L3 1.2L	2019-2020			FR7SI30	0242235769									
Montero	V6 3.8L	2012-2019			FR6KI332S	0242240653									
		2008-2011					FR7KPP33+	0242236564							
		2006-2006					FR7DPP33X	0242236631							
		2003-2006	FR7KII33X	0242236599					FR7DPP30T	0242236618					
Montero Sport	V6 3.0L	2012-2015	FR7DII33X	0242236596			FR7DPP33X	0242236631	FR7DPP30X	0242236616					
	V6 3.5L	2009-2011											FR8DCX+	0242229660	
		2003-2004	FR7DII33X	0242236596											
Outlander	L4 2.4L	2014-2020	YR8NII35U*	0242129526*											
		2011-2013	FR8DII33X/ FR7DII35X*	0242230534/ 0242236642*											
		2010-2013											FR8DCX+	0242229660	
		2008-2013							FR8DPP30T	0242230572					
	2004-2006			FR7SI332	0242236655										
Space Star	V6 3.0L	2007-2013	YR7NII33S	0242135533											
	L4 1.8L	2003-2004	FR8DII33X	0242230534			FR8DPP33X	0242230579	FR8DPP30X	0242230557	FR78X	0242232502	FR8DCX+	0242229660	

## NISSAN

240SX	L4 2.4L	1998-1998	FR7KII33X	0242236599										
		1998-1998	FR8KII33X	0242230528										
		1993-1998					FR8DPP33X	0242230579	FR8DPP30X	0242230557				
		1993-1998					FR7DPP33X	0242236631	FR7DPP30X	0242236616				
		1993-1993	FR8DII33X	0242230534									FR8DCX+	0242229660
		1993-1993	FR7DII33X	0242236596									FR7DCX+	0242235667
300ZX	V6 3.0L	1991-1996	FR8KII33X	0242230528			FR8DPP33X	0242230579	FR8DPP30X	0242230557				
		1991-1996	FR7KII33X	0242236599			FR7DPP33X	0242236631	FR7DPP30X	0242236616				



Marca / Modelo	Motor	Años	Doble Iridio		Iridio		Doble Platino		Platino		Super 4		Níquel	
			Fórmula	Nº. de Parte	Fórmula	Nº. de Parte	Fórmula	Nº. de Parte	Fórmula	Nº. de Parte	Fórmula	Nº. de Parte	Fórmula	Nº. de Parte
350Z	V6 3.5L	2007-2008	VR6NII35U*	0242140550*										
		2003-2006	FR7NII33X	0242236593			FR7MPP33X	0242236630	FR7NPP30X	0242236619	FR78NX	0242232515		
		2003-2006	FR8MII33X	0242230533			FR8MPP33X	0242230584	FR8MPP30X	0242230562				
370Z	V6 3.7L	2009-2020	VR6NII35U*	0242140550*										
Almera	L4 1.8L	2002-2005									FR78NX	0242232515	FR8ME+	F000KE0P24
		2001-2005	FR7DII33X	0242236596			FR7DPP33X	0242236631	FR7DPP30X	0242236616				
		2001-2001			FR6KI332S	0242240653					FR78X	0242232502	FR7DCX+	0242235667
Altima	L4 2.4L	2000-2001	FR7KII33X	0242236599										
		1998-2001	FR8KII33X	0242230528										
		1996-2001					FR8DPP33X	0242230579	FR8DPP30X	0242230557			FR8DCX+	0242229660
		1996-2001					FR7DPP33X	0242236631	FR7DPP30X	0242236616				
		1996-1997	FR7DII33X	0242236596							FR78X	0242232502	FR7DCX+	0242235667
		1996-1997	FR8DII33X	0242230534										
	L4 2.5L	2013-2018	VR7TII35U*	0242135531*										
		2007-2018											FR8ME+	F000KE0P24
		2007-2012	VR8NII35U*	0242129514*			VR8SPP33X	0242129516						
		2002-2006	FR8MII33X	0242230533			FR8MPP33X	0242230584	FR8MPP30X	0242230562				
		2002-2006	FR7NII33X	0242236593			FR7MPP33X	0242236630	FR7NPP30X	0242236619				
V6 3.5L	2007-2018	VR6NII35U*	0242140550*											
	2002-2006	FR7NII33X	0242236593			FR7MPP33X	0242236630	FR7NPP30X	0242236619	FR78NX	0242232515			
	2002-2006	FR8MII33X	0242230533			FR8MPP33X	0242230584	FR8MPP30X	0242230562					
Aprio	L4 1.6L	2009-2010											FR7DC+	0242235666
		2008-2010						FR7DPP30X	0242236616			HR8DCX+	0242229775	
Armada	V8 5.6L	2007-2015	FR8NII35U*	0242230554*										
		2005-2015					FR8MPP33X	0242230584	FR8MPP30X	0242230562				
		2005-2006	FR7NII33X	0242236593			FR7MPP33X	0242236630	FR7NPP30X	0242236619				
		2005-2006	FR8MII33X	0242230533										
Frontier	L4 2.4L	2011-2015	FR7DII33X	0242236596									FR7DCX+	0242235667
		2006-2008					VR8SPP33X	0242129516						
		2001-2015					FR7DPP33X	0242236631	FR7DPP30X	0242236616				
		2001-2004	FR7KII33X	0242236599			FR8DPP33X	0242230579	FR8DPP30X	0242230557				
		2001-2004	FR8KII33X	0242230528										
	V6 3.3L	2001-2004	FR8KII33X	0242230528			FR8DPP33X	0242230579	FR8DPP30X	0242230557				



N











Marca / Modelo	Motor	Años	Doble Iridio		Iridio		Doble Platino		Platino		Super 4		Níquel		
			Fórmula	Nº. de Parte	Fórmula	Nº. de Parte	Fórmula	Nº. de Parte	Fórmula	Nº. de Parte	Fórmula	Nº. de Parte	Fórmula	Nº. de Parte	
Frontier	V6 3.3L	2001-2001	FR7KII33X	0242236599			FR7DPP33X	0242236631	FR7DPP30X	0242236616					
		2001-2001	FR6KII33X	0242240669			FR6KPP33X+	0242240649							
	V6 4.0L	2019-2019	VR8SII33X	0242129529			VR8SPP33X	0242129516							
		2008-2019	FR8NII35U*	0242230554*											
Ichi Van	L4 1.8L	1987-1992											W8DC	0241229715	
		1987-1992											WR8DC+	0242229656	
	L4 2.4L	1992-1994							FR8HPP30X	0242230567					
Juke	L4 1.6L	2012-2017	VR6NII35T*	0242140536*											
Lucino	L4 1.6L	1997-2000									FR78X	0242232502			
		1996-2000	FR7DII33X	0242236596			FR7DPP33X	0242236631	FR7DPP30X	0242236616			FR8DCX+	0242229660	
		1996-2000											FR7DCX+	0242235667	
	L4 2.0L	1999-2000												FR7KC+	0242236561
		1996-2000			FR6KI332S	0242240653					FR78X	0242232502			
		1996-1998	FR8KII33X	0242230528			FR8DPP33X	0242230579	FR8DPP30X	0242230557			FR8DC+	0242229659	
		1996-1998							FR8DPP30T	0242230572			FR7DC+	0242235666	
		1996-1998	FR7KII33X	0242236599			FR7DPP33X	0242236631	FR7DPP30T	0242236618			FR5DC	0242245536	
1996-1998							FR7DPP30X	0242236616							
March	L4 1.6L	2012-2019			VR8SII30X	0242129522									
Maxima	V6 3.0L	1998-2001					FR6KPP33X+	0242240649							
		1993-2001	FR8KII33X	0242230528											
		1993-1997	FR7KII33X	0242236599											
		1991-2001							FR8DPP30X	0242230557					
		1991-1997					FR8DPP33X	0242230579	FR7DPP30X	0242236616					
		1991-1997					FR7DPP33X	0242236631							
		1991-1993									FR78X	0242232502			
		1991-1992	FR8DII33X	0242230534									FR8DCX+	0242229660	
	1991-1992	FR7DII33X	0242236596									FR7DCX+	0242235667		
	V6 3.5L	2009-2018	VR6NII35U*	0242140550*											
		2007-2008	FR8NII35U*	0242230554*											
		2006-2006	FR7NII35U*	0242236605*											
		2002-2007					FR8MPP33X	0242230584							
2002-2006		FR8MII33X	0242230533					FR8MPP30X	0242230562						
2002-2005	FR7NII33X	0242236593					FR7MPP33X	0242236630	FR7NPP30X	0242236619					

Marca / Modelo	Motor	Años	Doble Iridio		Iridio		Doble Platino		Platino		Super 4		Níquel		
			Fórmula	Nº. de Parte	Fórmula	Nº. de Parte	Fórmula	Nº. de Parte	Fórmula	Nº. de Parte	Fórmula	Nº. de Parte	Fórmula	Nº. de Parte	
Micra	L4 1.4L	2005-2007							FR8NPP30W	0242230602	FR78NX	0242232515			
Murano	V6 3.5L	2009-2020	VR6NII35U*	0242140550*											
		2004-2008	FR8MII33X	0242230533			FR8MPP33X	0242230584	FR8MPP30X	0242230562					
Note	L4 1.6L	2014-2019	VR8SII33X	0242129529	VR8SII30X	0242129522	VR8SPP33X	0242129516							
NP300	L4 2.4L	2009-2015	FR7DII33X	0242236596			FR7DPP33X	0242236631	FR7DPP30X	0242236616			FR7DCX+	0242235667	
	L4 2.5L	2016-2018	VR7TII35U*	0242135531*											
NP300 Frontier	L4 2.5L	2016-2018	VR7TII35U*	0242135531*											
NV2500	V6 4.0L	2013-2015	FR8NII35U*	0242230554*											
	V8 5.6L	2013-2013	FR8NII35U*	0242230554*											
NV350 Urvan	L4 2.5L	2014-2020	VR8NII35U*	0242129514*											
Pathfinder	V6 3.3L	1999-2000	FR7KII33X	0242236599											
		1998-2000	FR8KII33X	0242230528											
		1997-2000					FR7DPP33X	0242236631	FR7DPP30X	0242236616	FR78X	0242232502			
		1997-2000					FR8DPP33X	0242230579	FR8DPP30X	0242230557					
		1997-1998	FR8DII33X	0242230534										FR8DCX+	0242229660
		1997-1997	FR7DII33X	0242236596										FR7DCX+	0242235667
	V6 3.5L	2013-2020	VR8NII35U*	0242129514*											
		2001-2004	FR8MII33X	0242230533			FR8MPP33X	0242230584	FR8MPP30X	0242230562					
		2001-2004	FR7NII33X	0242236593			FR7MPP33X	0242236630	FR7NPP30X	0242236619					
	V6 4.0L	2012-2012	FR7NII35U*	0242236605*											
		2008-2012	FR8NII35U*	0242230554*											
		2005-2012					FR8MPP33X	0242230584	FR8MPP30X	0242230562					
		2005-2007	FR7NII33X	0242236593			FR7MPP33X	0242236630	FR7NPP30X	0242236619					
Pathfinder Armada	V8 5.6L	2004-2004	FR8MII33X	0242230533			FR8MPP33X	0242230584	FR8MPP30X	0242230562					
		2004-2004	FR7NII33X	0242236593			FR7MPP33X	0242236630	FR7NPP30X	0242236619					
Pickup	L4 2.4L	2005-2010	FR8DII33X	0242230534			FR8DPP33X	0242230579	FR8DPP30X	0242230557					
		2005-2010	FR7DII33X	0242236596			FR7DPP33X	0242236631	FR7DPP30X	0242236616					
		1998-2010											FR8DCX+	0242229660	
		1993-2004								FR8HPP30X	0242230567				
Platina	L4 1.6L	2002-2010	FR7DII33X	0242236596			FR7DPP33X	0242236631	FR7DPP30X	0242236616			FR7DCX+	0242235667	



N



 Marca / Modelo	 Motor	 Años	 Doble Iridio		 Iridio		 Doble Platino		 Platino		 Super 4		 Níquel	
			Fórmula	Nº. de Parte	Fórmula	Nº. de Parte	Fórmula	Nº. de Parte	Fórmula	Nº. de Parte	Fórmula	Nº. de Parte	Fórmula	Nº. de Parte
Quest	V6 3.3L	1999-2002	FR8KII33X	0242230528			FR8DPP33X	0242230579	FR8DPP30X	0242230557				
		1999-2002	FR7KII33X	0242236599			FR7DPP33X	0242236631	FR7DPP30X	0242236616				
	V6 3.5L	2004-2009	FR8MII33X	0242230533			FR8MPP33X	0242230584	FR8MPP30X	0242230562				
		2004-2009	FR7NII33X	0242236593			FR7MPP33X	0242236630	FR7NPP30X	0242236619				
Rogue	L4 2.5L	2008-2014	VR8NII35U*	0242129514*			VR8SPP33X	0242129516						
Sentra	L4 1.6L	2018-2019	VR6NII35T*	0242140536*										
		1996-2000	FR7DII33X	0242236596			FR7DPP33X	0242236631	FR7DPP30X	0242236616			FR8DCX+	0242229660
													FR7DCX+	0242235667
	L4 1.8L	2013-2019	VR8SII33X/ VR8NII35U*	0242129529/ 0242129514*			VR8SPP33X	0242129516						
		2001-2006	FR8MII33X	0242230533			FR8MPP33X	0242230584	FR8MPP30X	0242230562				
			FR7NII33X	0242236593			FR7MPP33X	0242236630	FR7NPP30X	0242236619				
	L4 2.0L	2007-2012	VR8NII35U*	0242129514*			VR8SPP33X	0242129516						
		2007-2011	VR8SII33X	0242129529										
		1998-2001	FR7KII33X	0242236599										
		1998-2001	FR8KII33X	0242230528										
		1996-2001	FR6KII33X	0242240669			FR8DPP33X	0242230579	FR8DPP30X	0242230557			FR8DC+	0242229659
		1996-2001					FR7DPP33X	0242236631	FR8DPP30T	0242230572			FR7DC+	0242235666
								FR6KPP33X+	0242240649	FR7DPP30X	0242236616			FR5DC
		1996-2001							FR7DPP30T	0242236618				
	L4 2.5L	1996-1997	FR7DII33X	0242236596										
		1996-1997	FR8DII33X	0242230534										
2007-2012		VR8NII35U*	0242129514*			VR8SPP33X	0242129516							
L4 2.5L	2002-2006	FR8MII33X	0242230533			FR8MPP33X	0242230584	FR8MPP30X	0242230562					
	2002-2006	FR7NII33X	0242236593			FR7MPP33X	0242236630	FR7NPP30X	0242236619					
Tiida	L4 1.6L	2016-2018	VR8SII33X	0242129529	VR8SII30X	0242129522								
		2014-2015	VR8NII35U*	0242129514*										
	L4 1.8L	2011-2013					VR7SPP33	0242135524						
2007-2018		VR8NII35U*	0242129514*											
Titan	V8 5.6L	2007-2015	FR8NII35U*	0242230554*										
		2004-2015	FR8MII33X	0242230533			FR8MPP33X	0242230584	FR8MPP30X	0242230562				
		2004-2006	FR7NII33X	0242236593			FR7MPP33X	0242236630	FR7NPP30X	0242236619				
Tsubame	L4 1.6L	1993-2004	FR8DII33X	0242230534			FR8DPP33X	0242230579	FR8DPP30X	0242230557			FR8DCX+	0242229660

Marca / Modelo	Motor	Años	Doble Iridio		Iridio		Doble Platino		Platino		Super 4		Níquel	
			Fórmula	Nº. de Parte	Fórmula	Nº. de Parte	Fórmula	Nº. de Parte	Fórmula	Nº. de Parte	Fórmula	Nº. de Parte	Fórmula	Nº. de Parte
Tsuru	L4 1.5L	1984-1985							WR8DPP30W	0242230599	WR78X	0242232505	WR8DCX+	0242229687
	L4 1.6L	1993-2017	FR7DII33X	0242236596			FR7DPP33X	0242236631	FR7DPP30X	0242236616				
		1993-1996	FR8DII33X	0242230534			FR8DPP33X	0242230579	FR8DPP30X	0242230557			FR8DCX+	0242229660
		1993-1996											FR7DCX+	0242235667
		1989-2017									FR78X	0242232502		
		1986-1992							WR8DPP30W	0242230599			WR8DCX+	0242229687
		1986-1988									WR78X	0242232505		
L4 2.0L	1995-1996	FR7DII33X	0242236596			FR7DPP33X	0242236631	FR7DPP30X	0242236616			FR7DCX+	0242235667	
Urvan	L4 2.4L	2008-2008	VR8NII35U*	0242129514*										
		2000-2007			FR8DII33X	0242230534	FR8DPP33X	0242230579	FR8DPP30X	0242230557	FR78X	0242232502	FR8DCX+	0242229660
	L4 2.5L	2008-2013	VR8NII35U*	0242129514*										
Versa	L4 1.6L	2019-2019					VR8SPP33X	0242129516						
		2012-2019	VR8SII33X	0242129529	VR8SII30X	0242129522								
Xterra	V6 3.3L	2002-2002	FR6KII33X	0242240669			FR6KPP33X+	0242240649						
		2000-2004	FR8KII33X	0242230528			FR8DPP33X	0242230579	FR8DPP30X	0242230557				
		2000-2001	FR7KII33X	0242236599			FR7DPP33X	0242236631	FR7DPP30X	0242236616				
	V6 4.0L	2005-2007	FR8MII33X	0242230533			FR8MPP33X	0242230584	FR8MPP30X	0242230562				
		2005-2007	FR7NII33X	0242236593			FR7MPP33X	0242236630	FR7NPP30X	0242236619				
X-Trail	L4 2.5L	2014-2017	VR7TII35U*	0242135531*										
		2007-2013	VR8NII35U*	0242129514*										
		2005-2006									FR78NX	0242232515		
		2002-2007	FR8MII33X	0242230533			FR8MPP33X	0242230584	FR8MPP30X	0242230562				

## OLDSMOBILE

Cutlass	V6 2.8L	1987-1989	HR9LII33X	0242225661			HR9LPP33X	0242225678	HR9LPP30X	0242225674				
	V6 3.1L	1996-1996					HR8DPP33Y	0242230581	HR8DPP30Y	0242230559			HR9DCY+	0242225623
		1994-1996	HR8KII33Y	0242230536										
		1987-1993	HR9LII33X	0242225661			HR9LPP33X	0242225678	HR9LPP30X	0242225674				
Silhouette	V6 3.1L	1991-1993						HR7BPP30X	0242236615					
	V6 3.8L	1994-1995	HR8KII33Y	0242230536			HR8DPP33Y	0242230581	HR8DPP30Y	0242230559			HR9DCY+	0242225623

Marca / Modelo	Motor	Años	Doble Iridio		Iridio		Doble Platino		Platino		Super 4		Níquel	
			Fórmula	Nº. de Parte	Fórmula	Nº. de Parte	Fórmula	Nº. de Parte	Fórmula	Nº. de Parte	Fórmula	Nº. de Parte	Fórmula	Nº. de Parte

**PEUGEOT**

206	L4 1.4L	2004-2009			FR6KI332S	0242240653					FR78X	0242232502	FR7DC+	0242235666	
		2000-2003						FR7DPP33X	0242236631	FR7DPP30T	0242236618				
	L4 1.6L	2002-2007								FR8NPP30W	0242230602			FR8SC+	0242229797
2001-2007											FR78NX	0242232515	FR8ME+	F000KE0P24	
207	L4 1.4L	2010-2011											FR6KDC+	0242240648	
	L4 1.6L	2012-2013			FR7NI33	0242236528									
		2010-2011			ZQR8SI302	0242129512			FR8NPP30W	0242230602	FR78NX	0242232515	FR8SC+	0242229797	
		2008-2013			ZR7SI332S	0242135518									
L4 1.6L Turbo	2010-2011			ZR7SI332S	0242135518										
208	L3 1.2L	2019-2021			ZR6SI332	0242140559									
	L4 1.6L	2014-2016			ZQR8SI302	0242129512									
301	L4 1.6L	2013-2021							FR8NPP30W	0242230602	FR78NX	0242232515	FR8SC+	0242229797	
306	L4 1.6L	1997-1997									FR78X	0242232502	FR7DC+	0242235666	
	L4 1.8L	2001-2002							FR7DPP30T	0242236618	FR78X	0242232502	FR7DC+	0242235666	
	L4 2.0L	2001-2002							FR7DPP30T	0242236618	FR78X	0242232502	FR7DC+	0242235666	
307	L4 2.0L	2006-2010											FR8SC+	0242229797	
		2003-2010									FR78NX	0242232515			
		2003-2009								FR8NPP30W	0242230602				
		2003-2005												FR8ME+	F000KE0P24
308	L4 1.6L	2019-2020	ZR6SII3320	0242140521											
		2017-2017			ZR5SI332	0242145537									
		2009-2016			ZR7SI332S	0242135518									
406	V6 2.9L	2003-2005					FR8SPP332	0242229708							
	V6 3.0L	2001-2002					FR8SPP332	0242229708							
407	L4 2.2L	2006-2009								FR8NPP30W	0242230602	FR78NX	0242232515	FR8ME+	F000KE0P24
	V6 2.9L	2007-2008	FR8KII33X	0242230528			FR8DPP33X	0242230579	FR8DPP30X	0242230557					
		2006-2006						FR8SPP332	0242229708						
508	L4 1.6L	2012-2017			ZR7SI332S	0242135518									
607	V6 2.9L	2002-2008					FR8SPP332	0242229708							
2008	L3 1.2L	2019-2021			ZR6SI332	0242140559									
	L4 1.6L	2014-2016			ZQR8SI302	0242129512									



Marca / Modelo	Motor	Años	Doble Iridio		Iridio		Doble Platino		Platino		Super 4		Níquel	
			Fórmula	Nº. de Parte	Fórmula	Nº. de Parte	Fórmula	Nº. de Parte	Fórmula	Nº. de Parte	Fórmula	Nº. de Parte	Fórmula	Nº. de Parte
3008	L4 1.6L	2011-2016			ZR7SI332S	0242135518								
207 Compact	L4 1.4L	2009-2011									FR78NX	0242232515	FR8ME+	F000KE0P24
	L4 1.6L	2010-2011			FR7NI33	0242236528								
		2009-2009			ZR7SI332S	0242135518								
208 GT	L4 1.6L	2014-2014			ZR7SI332S	0242135518								
Grand Raid	L4 1.6L	2008-2012									FR78NX	0242232515	FR8SC+	0242229797
Partner	L4 1.6L	2003-2012									FR78NX	0242232515	FR8SC+	0242229797
RCZ	L4 1.6L	2011-2016			ZR7SI332S	0242135518								

## PONTIAC

Aztek	V6 3.4L	2002-2005	HR9KII33Y	0242225659			HR9DPP33Y	0242225677	HR9DPP30Y	0242225670				
	V6 3.4L	2001-2001	HR8KII33Y	0242230536			HR8DPP33Y	0242230581	HR8DPP30Y	0242230559				
Bonneville	V6 3.8L	1995-1999	HR9KII33Y	0242225659			HR9DPP33Y	0242225677	HR9DPP30Y	0242225670				
		1994-1995										HR9DCY+	0242225623	
		1994-1994	HR8KII33Y	0242230536			HR8DPP33Y	0242230581	HR8DPP30Y	0242230559				
Firebird	V8 5.7L	2000-2001	HR8LII33U	0242230523			HR8LPP33U	0242230577	HR8LPP30U	0242230558				
		1998-1999	HR9KII33Y	0242225659										
		1996-1997	HR8KII33Y	0242230536			HR8DPP33Y	0242230581	HR8DPP30Y	0242230559				
		1994-1999					HR9DPP33Y	0242225677	HR9DPP30Y	0242225670				
		1994-1995	HR8KII33V	0242230535										
G3	L4 1.6L	2007-2009	FR7DII33X	0242236596			FR7DPP33X	0242236631	FR7DPP30X	0242236616				
G5	L4 2.2L	2007-2009	HR8MII33X	0242230611			HR8MPP33X	0242230582	HR8MPP30X	0242230564				
	L4 2.4L	2007-2008	HR8MII33X	0242230611			HR8MPP33X	0242230582	HR8MPP30X	0242230564				
G6	V6 3.5L	2007-2009	HR9LII33X	0242225661			HR9LPP33X	0242225678	HR9LPP30X	0242225674				
		2005-2006	HR9KII33Y	0242225659			HR9DPP33Y	0242225677	HR9DPP30Y	0242225670				
	V6 3.6L	2007-2009	HR8NII332X	0242230530					HR8NPP302	0242229739				
Grand Am	V6 3.4L	2002-2004	HR9KII33Y	0242225659			HR9DPP33Y	0242225677	HR9DPP30Y	0242225670				
		1999-2001	HR8KII33Y	0242230536			HR8DPP33Y	0242230581	HR8DPP30Y	0242230559				
Grand Prix	V6 3.1L	1997-1998	HR8KII33Y	0242230536			HR8DPP33Y	0242230581	HR8DPP30Y	0242230559				
	V6 3.8L	1997-2001	HR9KII33Y	0242225659			HR9DPP33Y	0242225677	HR9DPP30Y	0242225670				
Matiz	L4 1.0L	2004-2010							WR8DPP30W	0242230599		WR8DCX+	0242229687	
Montana	V6 3.5L	2005-2006	HR9KII33Y	0242225659			HR9DPP33Y	0242225677	HR9DPP30Y	0242225670				
	V6 3.9L	2007-2009	HR9LII33X	0242225661			HR9LPP33X	0242225678	HR9LPP30X	0242225674			HR9DCY+	0242225623











P

Marca / Modelo	Motor	Años	Doble Iridio		Iridio		Doble Platino		Platino		Super 4		Níquel	
			Fórmula	Nº. de Parte	Fórmula	Nº. de Parte	Fórmula	Nº. de Parte	Fórmula	Nº. de Parte	Fórmula	Nº. de Parte	Fórmula	Nº. de Parte
Solstice	L4 2.0L	2009-2009			HR8NI332W	0242230508								
	L4 2.4L	2006-2008	HR8MII33X	0242230611			HR8MPP33X	0242230582	HR8MPP30X	0242230564				
Sunfire	L4 2.2L	2004-2005	HR8MII33X	0242230611			HR8MPP33X	0242230582	HR8MPP30X	0242230564				
	L4 2.4L	1997-2002	HR8KII33V	0242230535			HR8DPP33V	0242230583	HR8DPP30V	0242230561				
Torrent	V6 3.4L	2006-2008	HR9KII33Y	0242225659			HR9DPP33Y	0242225677	HR9DPP30Y	0242225670				

## PORSCHE

911	H6 3.0L	2017-2019					ZR5NPP332SBP	0242145552							
	H6 3.4L	2012-2016											FGR5NQE04	0242245581	
		1999-2001											FGR6KQE	0242240587	
	H6 3.6L	2010-2012											FGR4NQE04	0242250518	
		2009-2012											FGR5NQE04	0242245581	
		2003-2004											FGR6KQE	0242240587	
		2002-2008											FGR5KQE0	0242245559	
		1998-1998											FR5DTC	0242245539	
		1996-2005									FR56	0242242501			
	H6 3.6L Turbo	1996-2004											FR6LDC	0242240566	
		2005-2005											FGR5KQE0	0242245559	
		2001-2005											FR6LDC	0242240566	
	H6 3.8L	1996-2001									FR56	0242242501			
		2017-2019						FR6NPP332	0242240637						
		2011-2012						FR6MPP332	0242240619						
		2010-2012											FGR4NQE04	0242250518	
2009-2016												FGR5NQE04	0242245581		
H6 3.8L Turbo	2005-2008											FGR5KQE0	0242245559		
	2010-2016						FR6NPP332	0242240637							
718 Boxster	H4 2.0L	2017-2019					ZR5NPP332SBP	0242145552							
718 Cayman	H4 2.0L	2017-2019					ZR5NPP332SBP	0242145552							
Boxster	H6 2.5L	1999-1999								FR7DPP30T	0242236618	FR78	0242232501	FR7LDC+	0242235668
	H6 2.7L	2013-2016												FGR5NQE04	0242245581
		2006-2008												FGR5KQE0	0242245559
		2001-2005												FGR6KQE	0242240587



 Marca / Modelo	 Motor	 Años	 Doble Iridio		 Iridio		 Doble Platino		 Platino		 Super 4		 Níquel		
			Fórmula	Nº. de Parte	Fórmula	Nº. de Parte	Fórmula	Nº. de Parte	Fórmula	Nº. de Parte	Fórmula	Nº. de Parte	Fórmula	Nº. de Parte	
Boxster	H6 2.9L	2010-2012											FGR5NQE04	0242245581	
	H6 3.2L	2006-2006											FGR5KQE0	0242245559	
		2001-2005											FGR6KQE	0242240587	
	H6 3.4L	2011-2016											FGR5NQE04	0242245581	
		2007-2008											FGR5KQE0	0242245559	
H6 3.8L	2016-2016											FGR5NQE04	0242245581		
Cayenne	V6 3.0L	2011-2018					FR5KPP332S	0242245576							
	V6 3.2L	2004-2006					YR7LPP332W	0242135510							
	V6 3.6L	2016-2018					FR5NPP332S	0242245585							
		2008-2010	YR6TII330T	0242140528											
	V8 4.5L	2003-2006											FGR6KQE	0242240587	
	V8 4.8L	2009-2018					FR6NPP332	0242240637							
		2009-2009					FR6MPP332	0242240619							
V8 4.8L Turbo	2008-2015					FR6NPP332	0242240637								
	2008-2014					FR6MPP332	0242240619								
Cayman	H6 2.7L	2014-2016											FGR5NQE04	0242245581	
		2007-2008											FGR5KQE0	0242245559	
	H6 2.9L	2009-2012											FGR5NQE04	0242245581	
	H6 3.4L	2009-2016												FGR5NQE04	0242245581
		2006-2008												FGR5KQE0	0242245559
H6 3.8L	2016-2016												FGR5NQE04	0242245581	
Macan	V6 3.0L	2015-2018					FR5NPP332S	0242245585							
	V6 3.6L	2015-2018					FR5NPP332S	0242245585							
Panamera	V6 3.0L	2014-2016					FR5NPP332S	0242245585							
		2012-2016					FR5KPP332S	0242245576							
	V6 3.6L	2012-2016											FGR5NQE04	0242245581	
	V8 4.8L	2010-2016											FGR5NQE04	0242245581	
	V8 4.8L Turbo	2010-2016					FR6NPP332	0242240637							
2010-2013						FR6MPP332	0242240619								



Marca / Modelo	Motor	Años	Doble Iridio		Iridio		Doble Platino		Platino		Super 4		Níquel	
			Fórmula	Nº. de Parte	Fórmula	Nº. de Parte	Fórmula	Nº. de Parte	Fórmula	Nº. de Parte	Fórmula	Nº. de Parte	Fórmula	Nº. de Parte

## RAM

1500	V6 3.6L	2014-2018	YR7SII3320U	0242135574	YR7SII302U	0242135555								
	V6 3.7L	2011-2013											FR7LCX+	0242236542
		2011-2012	FR7LI33X	0242236592										
	V8 5.7L	2013-2019	FR8SII33X	0242230571										
2013-2013						FR8SPP33X	0242230604	FR8SPP30X	0242230576			FR8SEX	0242230624	
2500	V8 4.7L	2010-2010			FR8TI332	0242229764							FR8TE2	0242229765
	V8 5.7L	2011-2019	FR8SII33X	0242230571										
		2011-2016					FR8SPP33X	0242230604	FR8SPP30X	0242230576				
	2011-2013											FR8SEX	0242230624	
V8 6.4L	2018-2019	FR8SII332X	0242230618	FR8SI332	0242230596									
4000	V8 5.7L	2011-2019	FR8SII33X	0242230571										
		2011-2013					FR8SPP33X	0242230604	FR8SPP30X	0242230576			FR8SEX	0242230624
	V8 6.4L	2019-2019			FR8SI332	0242230596								
ProMaster 1500	V6 3.6L	2014-2019	YR7SII3320U	0242135574	YR7SII302U	0242135555								
ProMaster 2500	V6 3.6L	2014-2019	YR7SII3320U	0242135574										
		2014-2018			YR7SII302U	0242135555								
ProMaster 3500	V6 3.6L	2014-2019	YR7SII3320U	0242135574	YR7SII302U	0242135555								

## RENAULT

Alliance	L4 1.4L	1984-1984					WR8LPP33X	0242230587						
	L4 1.7L	1985-1986							WR7DPP30W	0242236647			WR9DC+	0242225599
Clio	L4 1.6L	2002-2010							FR7DPP30X	0242236616			FR7DCX+	0242235667
	L4 2.0L	2002-2006					FR6KPP33X+	0242240649	FR8DPP30T	0242230572				
Duster	L4 2.0L	2013-2020					VR7SPP33	0242135524						
Encore	L4 1.7L	1985-1986							WR7DPP30W	0242236647			WR9DC+	0242225599
Euro Clio	L4 1.6L	2007-2008			FR6KI332S	0242240653			FR7DPP30X	0242236616	FR78X	0242232502	FR7DC+	0242235666
Fluence	L4 2.0L	2011-2017					VR7SPP33	0242135524						
Kangoo	L4 1.6L	2007-2009									FR78X	0242232502	FQR6DCW+	F000KE0P49
Kangoo Express	L4 1.6L	2004-2013							FR7DPP30X	0242236616	FR78X	0242232502	FQR6DCW+	F000KE0P49

Marca / Modelo	Motor	Años	Doble Iridio		Iridio		Doble Platino		Platino		Super 4		Níquel	
			Fórmula	Nº. de Parte	Fórmula	Nº. de Parte	Fórmula	Nº. de Parte	Fórmula	Nº. de Parte	Fórmula	Nº. de Parte	Fórmula	Nº. de Parte
Koleos	L4 2.5L	2009-2016	VR8NII35U*	0242129514*										
Laguna	L4 2.0L	2006-2006			FR7KI332S	0242236571	FR7KPP33U+	0242236544						
	V6 2.9L	2003-2006					FR8SPP332	0242229708						
Logan	L4 1.6L	2018-2019											FR7DCX+	0242235667
Megane	L4 1.6L	2008-2009			FR6KI332S	0242240653					FR78X	0242232502	FR7DC+	0242235666
	L4 2.0L	2003-2010									FR78X	0242232502		
		2003-2009			FR6KI332S	0242240653							FR7DC+	0242235666
L4 2.0L Turbo	2005-2009							FR7DPP+	0242235749					
R12	L4 1.3L	1974-1983											WR7BC+	0242235665
	L4 1.6L	1975-1977											WR7DC+	0242235663
R18	L4 1.6L	1980-1984								WR78	0242232504	WR7DC+	0242235663	
R5	L4 1.3L	1981-1981										WR7BC+	0242235665	
Sandero	L4 1.6L	2010-2015											FR7DCX+	0242235667
		2010-2014											FR7DC+	0242235666
	2010-2011									FR78	0242232501			
L4 2.0L	2016-2020											FR7DC+	0242235666	
Scenic	L4 2.0L	2004-2004			FR6KI332S	0242240653					FR78X	0242232502		
		2001-2004											FR7DC+	0242235666
		2001-2003					FR7DPP33X	0242236631	FR7DPP30T	0242236618				
Scenic II	L4 2.0L	2005-2008			FR6KI332S	0242240653				FR78X	0242232502	FR7DC+	0242235666	
Stepway	L4 1.6L	2010-2019										FR7DCX+	0242235667	

**ROVER**

75	V6 2.5L	2000-2005					FR7KPP33U+	0242236544						
----	---------	-----------	--	--	--	--	------------	------------	--	--	--	--	--	--

**SAAB**

9-3	L4 2.0L	2001-2009					FR6KPP33X+	0242240649						
9-5	L4 2.3L	2006-2006											FR5DC	0242245536
		2002-2006											FR7DCX+	0242235667
		2001-2006					FR6KPP33X+	0242240649						
V6 3.0L	2001-2001					FR6KPP33X+	0242240649							



Marca / Modelo	Motor	Años	Doble Iridio		Iridio		Doble Platino		Platino		Super 4		Níquel	
			Fórmula	Nº. de Parte	Fórmula	Nº. de Parte	Fórmula	Nº. de Parte	Fórmula	Nº. de Parte	Fórmula	Nº. de Parte	Fórmula	Nº. de Parte

**SEAT**

Alhambra	L4 1.8L	2002-2007					FR7KPP33+	0242236564						
	V6 2.8L	2007-2008					FR7HPP33+	0242236566						
Altea	L4 1.4L	2010-2012			FR6HI332	0242240665								
Altea XL	L4 1.8L	2010-2015					FR5KPP332S	0242245576						
Cordoba	L4 1.6L	2007-2009											FR6LES	0242240659
		2004-2009										FLR7HTC0	0242235788	
		2001-2009								FR78X	0242232502			
		2001-2002			FR6KI332S	0242240653			FR7DPP30T	0242236618			FR7LDC+	0242235668
	L4 2.0L	2003-2009			FR6KI332S	0242240653			FR7DPP30T	0242236618	FR78X	0242232502	FR7LDC+	0242235668
Exeo	L4 2.0L	2011-2011					FR5KPP332S	0242245576						
Freerack	L4 2.0L	2010-2013					FQ5NPP332S	0241245673						
		2009-2015					FR5KPP332S	0242245576						
Ibiza	L4 1.2L	2016-2017					Y5KPP332	0241145523						
		2013-2015			FR6HI332	0242240665								
	L4 1.4L	2011-2012			FR6HI332	0242240665								
	L4 1.6L	2004-2009											FLR7HTC0	0242235788
		2001-2015								FR78X	0242232502	FR7LDC+	0242235668	
	L4 1.8L	2005-2008					FR7KPP33+	0242236564			FR78	0242232501		
	L4 2.0L	2003-2015											FR7LDC+	0242235668
2003-2009									FR78X	0242232502				
Leon	L4 1.4L	2014-2018					Y5KPP332	0241145523						
		2008-2013			FR6HI332	0242240665								
	L4 1.6L	2007-2007								FR78X	0242232502	FR7LDC+	0242235668	
	L4 1.8L	2010-2013						FR5KPP332S	0242245576					
		2005-2005								FR7DPP30T	0242236618			
		2004-2004						FR7KPP33+	0242236564			FR78	0242232501	
		2001-2004									FR78X	0242232502	FR7LDC+	0242235668
	L4 1.8L Turbo	2001-2003					FR7KPP33+	0242236564			FR78	0242232501		
	L4 2.0L	2009-2013						FR5KPP332S	0242245576					
2006-2008				FR6KI332S	0242240653							FR7DE2	0242235797	
L4 2.0L Turbo	2007-2008					FR5KPP332S	0242245576							



Marca / Modelo	Motor	Años	Doble Iridio		Iridio		Doble Platino		Platino		Super 4		Níquel	
			Fórmula	Nº. de Parte	Fórmula	Nº. de Parte	Fórmula	Nº. de Parte	Fórmula	Nº. de Parte	Fórmula	Nº. de Parte	Fórmula	Nº. de Parte
Legacy	H4 2.0L	2008-2009			FR7NI33	0242236528								
	H4 2.5L	2014-2015	VR7SII33U	0242135553										
		2010-2012	FR7KII33X	0242236599			FR7DPP33X	0242236631	FR7DPP30X	0242236616				
		2009-2009	FR8KII33X	0242230528			FR8DPP33X	0242230579	FR8DPP30X	0242230557				
	H4 2.5L Turbo	2006-2007	FR6NII332S	0242240715										
	H6 3.0L	2008-2009			FR7NI33	0242236528								
H6 3.6L	2014-2015	FR7NII33X	0242236593			FR7MPP33X	0242236630	FR7NPP30X	0242236619					
Outback	H4 2.5L	2014-2017	VR7SII33U	0242135553										
		2010-2012	FR7KII33X	0242236599			FR7DPP33X	0242236631	FR7DPP30X	0242236616				
		2006-2008	FR6NII332S	0242240715										
	H6 3.6L	2010-2017	FR7NII33X	0242236593			FR7MPP33X	0242236630	FR7NPP30X	0242236619				
Tribeca	H6 3.6L	2010-2012	FR7NII33X	0242236593			FR7MPP33X	0242236630	FR7NPP30X	0242236619				
		2008-2009	FR6NII332S	0242240715										
WRX	H4 2.0L	2018-2020	FR6NII332S	0242240715										
	H4 2.5L	2015-2019	VR6NII332	0242140557										
WRX STI	H4 2.5L	2012-2016	FR6NII332S	0242240715										
		2020-2020	VR6NII332	0242140557										
XV	H4 2.0L	2017-2019	FR6NII332S	0242240715										
		2013-2016	VR7SII33U	0242135553										

## SUZUKI









Aerio	L4 2.3L	2006-2007	FR8KII33X	0242230528			FR8DPP33X	0242230579	FR8DPP30X	0242230557				
Grand Vitara	L4 2.4L	2009-2017	FR7NII33X	0242236593			FR7MPP33X	0242236630	FR7NPP30X	0242236619				
	V6 2.7L	2007-2008									FR78X	0242232502		
		2006-2008	FR7KII33X	0242236599			FR6KPP33X+	0242240649						
	V6 3.2L	2009-2010	HR8NII332X	0242230530					HR8NPP302	0242229739				
Ignis	L4 1.2L	2017-2021	YR8SII33U	0242129524										
Kizashi	L4 2.4L	2015-2016											YR8SEU	0242129515
		2010-2014	FR7NII33X	0242236593			FR7MPP33X	0242236630	FR7NPP30X	0242236619				
Swift	L4 1.5L	2007-2011					FR6KPP33X+	0242240649						
	L4 1.6L	2013-2017	FR7NII33X	0242236593			FR7MPP33X	0242236630	FR7NPP30X	0242236619				
SX4	L4 2.0L	2008-2009	FR8KII33X	0242230528			FR8DPP33X	0242230579	FR8DPP30X	0242230557				
Vitara	L4 1.6L	2016-2016	FR7NII33X	0242236593			FR7MPP33X	0242236630	FR7NPP30X	0242236619				

Marca / Modelo	Motor	Años	Doble Iridio		Iridio		Doble Platino		Platino		Super 4		Níquel	
			Fórmula	Nº. de Parte	Fórmula	Nº. de Parte	Fórmula	Nº. de Parte	Fórmula	Nº. de Parte	Fórmula	Nº. de Parte	Fórmula	Nº. de Parte

**TOYOTA**

4Runner	V6 4.0L	2006-2007	FR7NII33X	0242236593			FR7MPP33X	0242236630	FR7NPP30X	0242236619	FR78NX	0242232515		
	V8 4.7L	2003-2008	FR7KII33X	0242236599			FR7DPP33X	0242236631	FR7DPP30X	0242236616				
Avanza	L4 1.5L	2016-2020	VR8SII33X	0242129529										
		2007-2012									YR78X	0242132501	YR7DC+	0242135515
Camry	L4 2.4L	2002-2009	FR7KII33X	0242236599			FR7DPP33X	0242236631	FR7DPP30X	0242236616				
	L4 2.5L	2010-2017	FR8MII33X	0242230533			FR8MPP33X	0242230584	FR8MPP30X	0242230562				
	V6 3.0L	2002-2006	FR7KII33X	0242236599			FR7DPP33X	0242236631	FR7DPP30X	0242236616				
	V6 3.5L	2017-2017	FR7KII33X	0242236599			FR7DPP33X	0242236631	FR7DPP30X	0242236616				
2007-2017		FR7NII35U*	0242236605*											
C-HR	L4 2.0L	2018-2020	VR8SII33X	0242129529										
Corolla	L4 1.8L	2009-2019	VR8SII33X	0242129529										
		2009-2009											FR7KCX+	0242236541
		2003-2009	FR8KII33X	0242230528			FR8DPP33X	0242230579	FR8DPP30X	0242230557				
	L4 2.4L	2003-2008									FR78X	0242232502		
		2009-2013	FR7KII33X	0242236599			FR7DPP33X	0242236631						
	2009-2012							FR7DPP30X	0242236616					
FJ Cruiser	V6 4.0L	2014-2014	FR8MII33X	0242230533			FR8MPP33X	0242230584	FR8MPP30X	0242230562				
		2008-2014	FR7NII33X	0242236593			FR7MPP33X	0242236630	FR7NPP30X	0242236619				
Hiace	L4 2.7L	2006-2019									FR78NX	0242232515		
		2006-2017	FR7NII33X	0242236593			FR7MPP33X	0242236630	FR7NPP30X	0242236619				
Highlander	V6 3.5L	2017-2020	FR7NII35S*	0242236604*										
		2014-2016	FR7KII33X	0242236599			FR7DPP33X	0242236631	FR7DPP30X	0242236616				
		2008-2016	FR7NII35U*	0242236605*										
Hilux	L4 2.7L	2009-2016									FR78NX	0242232515		
		2004-2020	FR7NII33X	0242236593			FR7MPP33X	0242236630	FR7NPP30X	0242236619				
Land Cruiser	V8 4.7L	2004-2007	FR7KII33X	0242236599			FR7DPP33X	0242236631	FR7DPP30X	0242236616				
	V8 5.7L	2008-2019	FR7NII33X	0242236593			FR7MPP33X	0242236630	FR7NPP30X	0242236619				
Matrix	L4 1.8L	2009-2010	VR8SII33X	0242129529										
		2008-2008											FR8DCX+	0242229660
		2003-2008	FR8KII33X	0242230528			FR8DPP33X	0242230579	FR8DPP30X	0242230557				
	L4 2.4L	2009-2010	FR7KII33X	0242236599			FR7DPP33X	0242236631	FR7DPP30X	0242236616				



 Marca / Modelo	 Motor	 Años	 Doble Iridio		 Iridio		 Doble Platino		 Platino		 Super 4		 Níquel		
			Fórmula	Nº. de Parte	Fórmula	Nº. de Parte	Fórmula	Nº. de Parte	Fórmula	Nº. de Parte	Fórmula	Nº. de Parte	Fórmula	Nº. de Parte	Fórmula
MR2 Spyder	L4 1.8L	2006-2006												FR8DCX+	0242229660
		2005-2006	FR8KII33X	0242230528			FR8DPP33X	0242230579	FR8DPP30X	0242230557	FR78X	0242232502			
Prius	L4 1.8L	2016-2017	VR8NII35U*	0242129514*											
		2010-2015	VR8SII33X	0242129529											
Prius C	L4 1.5L	2018-2019	FR7KII35T*	0242236670*											
RAV4	L4 2.4L	2004-2008	FR7KII33X	0242236599				FR7DPP33X	0242236631	FR7DPP30X	0242236616				
	L4 2.5L	2009-2018	FR8MII33X	0242230533				FR8MPP33X	0242230584	FR8MPP30X	0242230562				
	V6 3.5L	2009-2012	FR7NII35U*	0242236605*											
Sequoia	V8 4.7L	2009-2012												FR8DC+	0242229659
		2008-2012	FR7KII33X	0242236599			FR7DPP33X	0242236631	FR7DPP30X	0242236616					
	V8 5.7L	2009-2019	FR7NII33X	0242236593			FR7MPP33X	0242236630	FR7NPP30X	0242236619					
Sienna	V6 3.0L	2003-2003	FR7KII33X	0242236599	FR6K1332S	0242240653	FR7DPP33X	0242236631	FR7DPP30X	0242236616	FR78X	0242232502			
	V6 3.3L	2004-2006	FR7KII33X	0242236599			FR7DPP33X	0242236631	FR7DPP30X	0242236616					
	V6 3.5L	2017-2020	FR7NII35S*	0242236604*											
2007-2016		FR7NII35U*	0242236605*												
Solara	V6 3.3L	2005-2006	FR7KII33X	0242236599			FR7DPP33X	0242236631	FR7DPP30X	0242236616					
Tacoma	V6 3.5L	2016-2020	FR7NII35S*	0242236604*											
	V6 4.0L	2006-2015	FR7NII33X	0242236593			FR7MPP33X	0242236630	FR7NPP30X	0242236619					
Tundra	V6 4.0L	2007-2007	FR7NII33X	0242236593			FR7MPP33X	0242236630	FR7NPP30X	0242236619					
	V8 4.7L	2007-2010	FR7KII33X	0242236599			FR7DPP33X	0242236631	FR7DPP30X	0242236616					
	V8 5.7L	2009-2020	FR7NII33X	0242236593			FR7MPP33X	0242236630	FR7NPP30X	0242236619					
Yaris	L4 1.3L	2004-2005	FR8KII33X	0242230528	FR6K1332S	0242240653			FR8DPP30T	0242230572	FR78	0242232501			
		2010-2012												FR8DC+	0242229659
	L4 1.5L	2006-2016	FR8KII33X	0242230528			FR8DPP33X	0242230579	FR8DPP30X	0242230557					
Yaris R	L4 1.5L	2016-2020	VR7NII33X	0242135529											

## VOLKSWAGEN

Amarok	L4 2.0L	2012-2014					FR5KPP332S	0242245576							
Atlantic	L4 1.7L	1981-1981							WR7DPP30W	0242236647	WR78	0242232504	WR7DC+	0242235663	
		1984-1984							WR7DPP30W	0242236647					
Beetle	L4 1.8L	2000-2005					FR7KPP33+	0242236564			FR78	0242232501			
	L4 2.0L	2015-2017					FQ5NPP332S	0241245673							



Marca / Modelo	Motor	Años	Doble Iridio		Iridio		Doble Platino		Platino		Super 4		Níquel		
			Fórmula	Nº. de Parte	Fórmula	Nº. de Parte	Fórmula	Nº. de Parte	Fórmula	Nº. de Parte	Fórmula	Nº. de Parte	Fórmula	Nº. de Parte	
Beetle	L4 2.0L	2012-2013					FR5KPP332S	0242245576							
		2003-2003											FR6DC+	0242240593	
		2000-2009						FR7HPP33+	0242236566						
		1998-2005										FR78X	0242232502		
		1998-2001			FR6KI332S	0242240653				FR7DPP30T	0242236618			FR7LDC+	0242235668
	1998-1998	FR6KII33X	0242240669												
	L5 2.5L	2009-2014												FR7HE02	0242236530
		2008-2010										FR78X	0242232502		
2008-2008							FR7HPP33+	0242236566							
Beetle Cabrio	L5 2.5L	2010-2010					FR7KPP33+	0242236564			FR78X	0242232502	FR7HE02	0242236530	
Bora	L4 2.0L	2006-2009					FR5KPP332S	0242245576							
		2008-2010											FR7HE02	0242236530	
	L5 2.5L	2006-2010									FR78X	0242232502			
		2006-2007						FR7HPP33+	0242236566						
Cabrio	L4 2.0L	1996-2002							FR8DPP30T	0242230572					
Caddy	L4 1.2L	2014-2015	FR6HI332	0242240665											
	L4 1.6L	2018-2020											Y7LER02	0241135520	
CC	L4 2.0L	2014-2017					FR5KPP332S	0242245576							
	V6 3.6L	2013-2013	YR6TII330T	0242140528											
Clasico	L4 1.8L	2011-2012					FR7KPP33+	0242236564			FR78	0242232501			
	L4 2.0L	2011-2015											FLR7HTC0	0242235788	
Combi	H4 1.6L	1984-1988									WR78	0242232504			
		1974-1979							WR8APP30T	0242230603			W7DC	0241235755	
		1974-1979											WR6DC+	0242240592	
	L4 1.8L	1988-1994											W8DC	0241229715	
		1988-1994											WR9DC+	0242225599	
Corsar	L4 1.8L	1986-1988								WR78	0242232504	WR7DC+	0242235663		
CrossFox	L4 1.6L	2007-2009											FLR7HTC0	0242235788	
Derby	L4 1.8L	2002-2009												WR7LTC+	0242235664
		2002-2002												WR7LT+	F000KE0P05
		1998-2009								FR7DPP30T	0242236618	WR78X	0242232505		
		1998-2002												W7DTC	0241236839
		1995-1997												FR7LDC+	0242235668



V



Marca / Modelo	Motor	Años	Doble Iridio		Iridio		Doble Platino		Platino		Super 4		Níquel		
			Fórmula	Nº. de Parte	Fórmula	Nº. de Parte	Fórmula	Nº. de Parte	Fórmula	Nº. de Parte	Fórmula	Nº. de Parte	Fórmula	Nº. de Parte	
Derby	L4 2.0L	2002-2003							FR8DPP30T	0242230572			WR7LTC+	0242235664	
Eos	L4 2.0L	2010-2010					FR5KPP332S	0242245576							
EuroVan	L5 2.5L	2001-2004									FR78X	0242232502			
		2001-2003											FR7LDC+	0242235668	
Gol	L4 1.6L	2000-2000	FR8KII33X	0242230528			FR8DPP33X	0242230579	FR8DPP30X	0242230557			F6DTC	0241240609	
		2000-2000											FGR8KQE	0242229613	
Gol	L4 1.6L	2016-2019					FR7HPP33+	0242236566							
		2009-2013											FLR7HTC0	0242235788	
Gol Sedan	L4 1.6L	2010-2012											FR5DE2	F000KE0P30	
Golf	L4 1.8L	1993-1998											W7DTC	0241236839	
		1993-1998											WR7LTC+	0242235664	
		1993-1998											WR7LT+	F000KE0P05	
		1991-1991											W8DC	0241229715	
		1989-1998									WR78	0242232504			
		1989-1989									FR56	0242242501	F6DTC	0241240609	
		1987-1992							WR7DPP30W	0242236647					
		1987-1991												WR7DC+	0242235663
	1987-1988										WR78X	0242232505			
	L4 2.0L	2002-2003	FR6KII33X	0242240669											
		2001-2006					FR7HPP33+	0242236566							
		2000-2001					FR7KPP33+	0242236564							
		1999-2007			FR6KI332S	0242240653			FR7DPP30T	0242236618	FR78X	0242232502	FR7LDC+	0242235668	
		1995-1999							FR8DPP30T	0242230572					
1996-1998						FR8DPP33X	0242230579					FGR8KQE	0242229613		
Golf R	L4 2.0L	2018-2019					FQ5NPP332S	0241245673							
GTI	L4 2.0L	2018-2018					FQ5NPP332S	0241245673							
		2007-2013					FR5KPP332S	0242245576							
Jetta	L4 1.8L	2005-2005									FR78	0242232501			
		2000-2010					FR7KPP33+	0242236564							
		1999-1999											WR7DC+	0242235663	
		1993-1998									WR78X	0242232505	WR7LTC+	0242235664	
		1990-1998							WR7DPP30W	0242236647					
1990-1992												W7DTC	0241236839		

Marca / Modelo	Motor	Años	Doble Iridio		Iridio		Doble Platino		Platino		Super 4		Níquel		
			Fórmula	Nº. de Parte	Fórmula	Nº. de Parte	Fórmula	Nº. de Parte	Fórmula	Nº. de Parte	Fórmula	Nº. de Parte	Fórmula	Nº. de Parte	
Jetta	L4 1.8L	1987-1999									WR78	0242232504			
		1987-1989											W8DC	0241229715	
		1987-1989											WR6DC+	0242240592	
	L4 1.8L Turbo	1999-1999					FR7KPP33+	0242236564							
	L4 2.0L	2019-2019						FQ5NPP332S	0241245673						
		2013-2015												FR7HE02	0242236530
		2012-2015							FR6KPP332S	0242240627					
		2005-2010												FLR7HTC0	0242235788
		2001-2004							FR7HPP33+	0242236566					
		1999-2015										FR78X	0242232502		
		1999-2004												FR7LDC+	0242235668
		1999-2001	FR6KII33X	0242240669						FR7DPP30T	0242236618				
	1993-1998								FR8DPP30T	0242230572					
	L4 2.0L Turbo	2016-2017						FQ5NPP332S	0241245673						
L4 2.0L Turbo	2007-2008						FR5KPP332S	0242245576							
L5 2.5L	2011-2018						FR6KPP332S	0242240627							
V6 2.8L	1999-2002	FR8KII33X	0242230528				FR8DPP33X	0242230579	FR8DPP30X	0242230557			FGR8KQE	0242229613	
Lupo	L4 1.6L	2005-2009											FR7LDC+	0242235668	
Passat	L4 1.8L	2002-2005									FR78	0242232501			
		1999-2005					FR7KPP33+	0242236564							
	L4 2.0L	2006-2010					FR5KPP332S	0242245576							
	L5 2.5L	2012-2017												FR7HE02	0242236530
		2012-2016									FR78X	0242232502			
	V6 2.8L	1999-2005	FR6KII33X	0242240669										FGR7DQE+	0242235748
		1996-1997												FGR8KQE	0242229613
V6 3.6L	2006-2018	YR6TII330T	0242140528												
W8 4.0L	2003-2004						FR7KPP33+	0242236564			FR78X	0242232502			
Passat CC	L4 2.0L	2010-2010					FR5KPP332S	0242245576							
	V6 3.6L	2010-2010	YR6TII330T	0242140528											
Pointer	L4 1.8L	2006-2009								WR7DPP30W	0242236647				
		2005-2009												FLR7HTC0	0242235788
		1998-2005										WR78X	0242232505	WR7LTC+	0242235664
Pointer Truck	L4 1.8L	2006-2006									FR78X	0242232502	FR7HE02	0242236530	



V



Marca / Modelo	Motor	Años	Doble Iridio		Iridio		Doble Platino		Platino		Super 4		Níquel	
			Fórmula	Nº. de Parte	Fórmula	Nº. de Parte	Fórmula	Nº. de Parte	Fórmula	Nº. de Parte	Fórmula	Nº. de Parte	Fórmula	Nº. de Parte
C70	L5 2.5L	2012-2013	FR7NII35U*	0242236605*										
		2006-2013			FR7NI33	0242236528			FR7MPP10	0242235743				
S40	L4 1.9L	2001-2003											FR7DC+	0242235666
		1999-2004							FR7DPP+	0242235749				
	L4 2.0L	2011-2011					HR7KPP33+	0242236563						
	L5 2.4L	2007-2010											FGR6NQE0	0242240635
	L5 2.5L	2004-2012			FR7NI33	0242236528								
		2004-2011							FR7MPP10	0242235743				
S60	L4 1.6L	2011-2015	HR7TII3320T	0242236683										
	L5 2.0L	2004-2004							FR7MPP10	0242235743				
		2001-2004							FR7DPP+	0242235749				
	L5 2.3L	2001-2005							FR7DPP+	0242235749				
	L5 2.4L	2006-2008			FR7NI33	0242236528			FR7MPP10	0242235743				
		2001-2003							FR7DPP+	0242235749			FR7DC+	0242235666
	L5 2.5L	2004-2007			FR7NI33	0242236528			FR7MPP10	0242235743				
		2004-2007							FR7DPP+	0242235749				
L6 3.0L	2015-2015							FR7DPP+	0242235749					
		2011-2015	FR7NII35U*	0242236605*										
S60 Cross Country	L5 2.5L	2016-2016	FR7NII35S*	0242236604*										
S70	L5 2.3L	2000-2000							FR7DPP+	0242235749			FR7DC+	0242235666
	L5 2.4L	2000-2000							FR7DPP+	0242235749				
		1999-1999											FR7DC+	0242235666
S80	L5 2.5L	2005-2006							FR7DPP+	0242235749				
	L6 2.8L	2002-2003	FR7DII33X	0242236596			FR7DPP33X	0242236631	FR7DPP30T	0242236618				
		1999-2001							FR7DPP+	0242235749				
		1999-2000											FR7DC+	0242235666
	L6 2.9L	2004-2006							FR7DPP+	0242235749				
		2000-2003											FGR7DQE+	0242235748
	L6 3.0L	2011-2015	FR7NII35U*	0242236605*										
2010-2015				FR7NI33	0242236528									
L6 3.2L	2008-2009			FR7NI33	0242236528									
V8 4.4L	2010-2010	FR7KII33X	0242236599			FR7KPP33U+	0242236544	FR7DPP30X	0242236616					



V



Marca / Modelo	Motor	Años	Doble Iridio		Iridio		Doble Platino		Platino		Super 4		Níquel	
			Fórmula	Nº. de Parte	Fórmula	Nº. de Parte	Fórmula	Nº. de Parte	Fórmula	Nº. de Parte	Fórmula	Nº. de Parte	Fórmula	Nº. de Parte
V40	L4 1.6L	2014-2015	HR7TII3320T	0242236683										
	L4 1.9L	2001-2003											FR7DC+	0242235666
		2000-2004							FR7DPP+	0242235749				
		1999-1999							FR7DPP30T	0242236618				
	L4 2.0L	2014-2015			FR7NI33	0242236528								
L5 2.0L	2014-2015			FR7NI33	0242236528									
V50	L5 2.5L	2005-2007			FR7NI33	0242236528			FR7MPP10	0242235743				
V60 Cross Country	L5 2.5L	2016-2016	FR7NII35S*	0242236604*										
V70	L5 2.3L	2000-2003							FR7DPP+	0242235749				
		2000-2000										FR7DC+	0242235666	
	L5 2.4L	1999-2003							FR7DPP+	0242235749			FR7DC+	0242235666
XC60	L5 2.5L	2016-2016	FR7NII35S*	0242236604*										
	L6 3.0L	2010-2015	FR7NII35U*	0242236605*	FR7NI33	0242236528								
XC70	L5 2.5L	2004-2007							FR7DPP+	0242235749				
XC90	L5 2.5L	2004-2006							FR7DPP+	0242235749			FR7DC+	0242235666
	L6 2.9L	2003-2006							FR7DPP+	0242235749			FR7DC+	0242235666
	L6 3.2L	2007-2010			FR7NI33	0242236528								
	V8 4.4L	2006-2010	FR7KII33X	0242236599			FR7KPP33U+	0242236544	FR7DPP30X	0242236616				



### **CASA CENTRAL | MAR DEL PLATA**

Av. Colon 5757 (CP 7600) | Tel: (223) 410.4000  
ccentral@iturria.com.ar

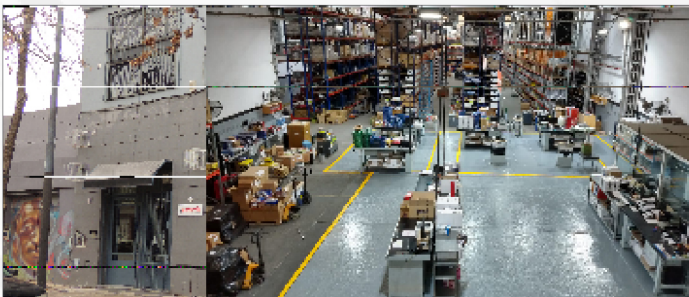

### **SUCURSAL CAPITAL FEDERAL**

Andonaegui 1035 (C1427BEC) | Tel: (011) 3526.3020  
sucursalcapital@iturria.com.ar



### **SUCURSAL BAHIA BLANCA**

Av. Colon 1477 (B8000FUE) | Tel: (0291) 455.0333  
sucursalbahia@iturria.com.ar

## **CATALOGO DIGITAL**

Con solo un click ahora puedes hacer todas tus compras desde **[catalogodigital.iturria.com.ar](http://catalogodigital.iturria.com.ar)**

