

CATALOGO DE **ESCOBILLAS**





Limpiaparabrisas Bosch

Bosch ICON™

ICON™ Clear Max 365

ICON™ Clear Max es un programa desarrollado con base en una innovadora tecnología que permite mejor desempeño, limpieza y vida útil bajo todas las condiciones climáticas, gracias a las innovaciones tecnológicas en la composición y cubierta de su goma.

Beneficios

- **Desempeño** consistente, suave y silencioso a lo largo de todo el año
- **Visibilidad** óptima en condiciones climáticas extremas
- **Desempeño** excepcional incluso en altas velocidades

Características

- **Innovadora** goma que combina la flexibilidad de sus componentes con la cobertura de un polímero resistente, lo que permite un rendimiento notablemente superior
- **Incremento** de cobertura gracias a su extenso programa que incluye 12 números de parte con conector de gancho y 8 números de parte equipados con multclip para conectores OE



40%

más vida útil que las plumas premium del mercado





Limpiaparabrisas Bosch Clear Advantage™

Alto desempeño para todo tipo de climas

Clear Advantage™ es la última novedad de la línea de limpiaparabrisas sin armazón Bosch. Ideal para todo tipo de vehículos con la calidad y el rendimiento que esperan de nuestra marca.

La hoja del limpiaparabrisas Clear Advantage™ puede soportar incluso el clima más extremo en cualquier época del año. Su alerón aerodinámico permite mantener la hoja adherida al parabrisas aún en altas velocidades.



Beneficios

- Proporciona **presión uniforme** a lo largo de toda la hoja
- **Mejora el flujo de aire** para crear más presión hacia el parabrisas
- **Protege** al resorte de tensión de la acumulación de hielo
- **Reduce** la fricción y el **ruido**
- **Fácil de instalar**

Características

- Resorte de acero que permite una **precisión y tensado perfecto**
- **Alerón aerodinámico**
- **Borde de goma natural** tratado con grafito
- **Adaptador múltiple** premontado



Resorte de acero para un tensado perfecto

Borde de goma natural tratado con grafito

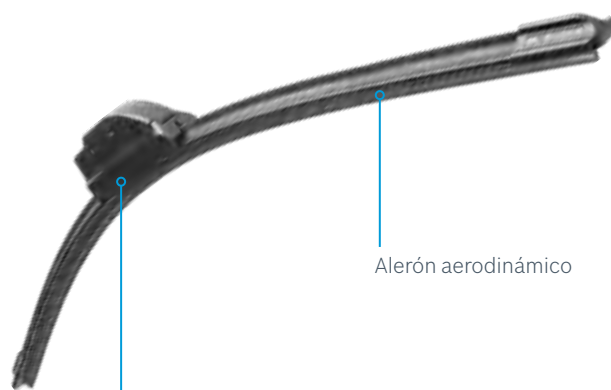

Alerón aerodinámico

Adaptador múltiple premontado

Sistema de adaptadores **Click-ON™**

El nuevo programa **Clear Advantage cuenta con el sistema de adaptadores Click-ON™** lo que simplifica el proceso de instalación

Conectores incluidos

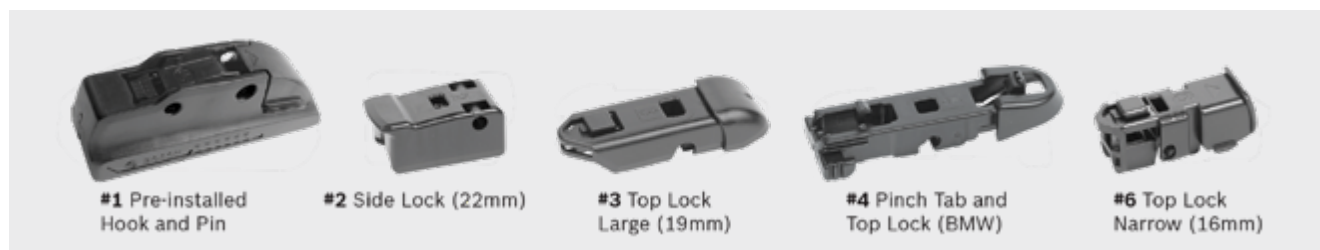

Brazos limpiaparabrisas cubiertos con el sistema de **adaptadores Click-On™**

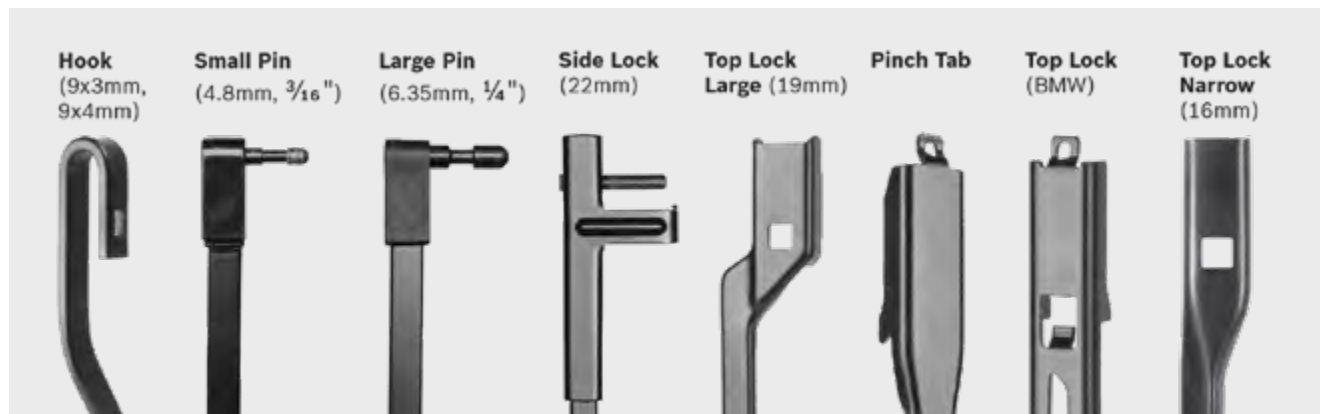

Equivalencia de números de parte

Descripción	Número de Parte Bosch Anterior	Nuevo Número de Parte Bosch
Clear Advantage 13"	3397006500	3397013668
Clear Advantage 15"	3397006501	3397013669
Clear Advantage 16"	3397006502	3397013670
Clear Advantage 17"	3397006503	3397013671
Clear Advantage 18"	3397006504	3397013672
Clear Advantage 19"	3397006505	3397013673
Clear Advantage 20"	3397006506	3397013674
Clear Advantage 21"	3397006507	3397013675
Clear Advantage 22"	3397006508	3397013676
Clear Advantage 24"	3397006509	3397013677
Clear Advantage 26"	3397006510	3397013678
Clear Advantage 28"	3397006511	3397013679



Limpiaparabrisas Bosch

Bosch ECO

El programa de plumas limpiaparabrisas ECO se renueva para atender mejor las necesidades de nuestros clientes:



Misma estabilidad y cobertura diferente empaque

El portafolio de la línea de limpiaparabrisas Bosch ECO incluye plumas que van desde 11" y hasta 28", en presentación individual y también en sets. Estas plumas cuentan con conector de gancho y perno lo que les permite ser utilizadas en la mayoría de los vehículos, tanto nuevos como de años anteriores. (Refiérase al catálogo para el detalle de cobertura).

Características

- **Amplia cobertura** del mercado
- **Empaque individual y en set**
- **Uniones** remachadas
- **Más puntos** de presión para mejor adaptación al parabrisas del vehículo
- **Nuevo diseño** del brazo central
- **Goma** natural y ecológica
- **Incluye** Conector Quick Clip para brazo de gancho

Cambio de número de parte

ANTERIOR		NUEVO			
10 DÍGITOS	MKT #	MKT #	10 DÍGITOS	INDIVIDUAL	JUEGO
3397004914	S18	45EC	3397015275	18"	
3397004915	S19	48EC	3397015276	19"	
3397004918	S22	55EC	3397015277	22"	
3397004910	S24	60EC	3397015278	24"	
3397004912	S16	40EC	3397015279	16"	
3397004917	S21	53EC	3397015280	21"	
3397004911	S14	34EC	3397015281	13"	
3397004916	S20	50EC	3397015282	20"	
3397004938	S26	65EC	3397015283	26"	
3397011517	S28	70EC	3397015284	28"	
3397004913	S17	42EC	3397015286	17"	
3397011296	S15	38EC	3397015285	15"	
3397005822	B018	4545EC	3397015287		18"/18"
3397010040	B340	5347EC	3397015288		21"/19"
3397005287	B550	5555EC	3397015289		22"/22"
3397005281	B130	4040EC	3397015290		16"/16"
3397005719	B011	2828EC	3397015291		11"/11"
3397005285	B178	5050EC	3397015292		20"/20"
3397005288	B602	6060EC	3397015293		24"/24"
3397010041	B015	4742EC	3397015294		19"/17"
3397005286	B530	5353EC	3397015295		21"/21"
3397005284	B180	4747EC	3397015296		19"/19"
3397010131	B315	5538EC	3397015297		22"/15"



Nuevo brazo central

El nuevo diseño del brazo central, con aberturas mayores y aerodinámicas, permite mayor paso de aire y garantiza una calidad de limpieza superior bajo las condiciones más adversas.



Goma natural

Nueva goma natural, resistente a condiciones extremas, prolongando la vida útil del limpiaparabrisas.



Empaque informativo y autoexplicativo

- Fácil identificación de la marca
- Ilustración técnica del producto
- Código simplificado



Limpiaparabrisas Bosch Traseros

Limpiadores traseros Bosch

La gama de limpiadores traseros Bosch provee una **limpieza suave y silenciosa** cuyo desempeño esta aunado a una **vida útil más prolongada**.

Cada vez más vehículos vienen equipados con este elemento, el cual **debe ser cambiado con la misma periodicidad que los limpiadores delanteros** para asegurar una visibilidad óptima que se traduzca en seguridad y confort en el manejo.



Recomendaciones de sustitución

Limpiaparabrisas en buenas condiciones se traducen **en comodidad y seguridad para el conductor.**

Limpiaparabrisas Bosch

Bosch líder mundial en la fabricación de sistemas de seguridad considera al limpiaparabrisas como un ítem de extrema importancia, porque la visibilidad al conducir es fundamental.

Los limpiaparabrisas Bosch son diseñados para obtener lo máximo en eficiencia y desempeño para una limpieza perfecta de la totalidad del parabrisas.

Sol, lluvia, cambios de temperatura y contacto con materiales corrosivos del ambiente, todo eso perjudica el desempeño de los limpiaparabrisas.

Recuerde que cuidar del mantenimiento de su vehículo es cuidar de usted mismo.

Sustituya los limpiaparabrisas al observar:

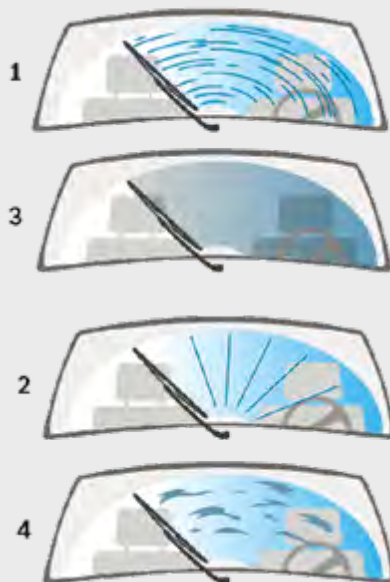

Problemas en el parabrisas

1. **Formación** de rayas y rasguños.
2. **Ruido** o trepidación.
3. **Formación** de niebla.
4. **Fallas** en la limpieza.

Problemas en las plumas

1. **Goma** quebradiza.
2. **Goma** rota.
3. **Goma** curvada.



Programa

Bosch tiene la línea más completa de limpiaparabrisas, con aplicaciones para todas las marcas de vehículos.

ICON™ Single		
Pulgadas	Nº de Parte	Nº Corto
13"	3397013245	13 A
15"	3397013246	15A
16"	3397013247	16A
17"	3397013248	17A
17"	3397013249	17B
18"	3397013250	18A
18"	3397013251	18B
19"	3397013252	19A
19"	3397013253	19B
20"	3397013254	20A
20"	3397013255	20B
21"	3397013256	21A
21"	3397013257	21B
22"	3397013258	22A
22"	3397013259	22B
24"	3397013260	24A
26"	3397013261	26A
28"	3397013262	28A
28"	3397013263	28B

ICON™ OE		
Pulgadas	Nº de Parte	Nº Corto
13"	3397013442	13OE
15"	3397013443	15OE
17"	3397013014	17OE
18"	3397013015	18OE
19"	3397013016	19OE
20"	3397013017	20OE
21"	3397013018	21OE
22"	3397013019	22OE
24"	3397013020	24OE
26"	3397013021	26OE
28"	3397013224	28AOE
28"	3397013225	28BOE

Clear Advantage™ Single		
Pulgadas	Nº de Parte	Nº Corto
13"	3397013668	CA13
15"	3397013669	CA15
16"	3397013670	CA16
17"	3397013671	CA17
18"	3397013672	CA18
19"	3397013673	CA19
20"	3397013674	CA20
21"	3397013675	CA21
22"	3397013676	CA22
24"	3397013677	CA24
26"	3397013678	CA26
28"	3397013679	CA28

ECO Single		
Pulgadas	Nº de Parte	Nº Corto
13"	3397015281	34EC
15"	3397015285	38EC
16"	3397015279	40EC
17"	3397015286	42EC
18"	3397015275	45EC
19"	3397015276	48EC
20"	3397015282	50EC
21"	3397015280	53EC
22"	3397015277	55EC
24"	3397015278	60EC
26"	3397015283	65EC
28"	3397015284	70EC

ECO Set		
Pulgadas	Nº de Parte	Nº Corto
11"/11"	3397015291	2828EC
16"/16"	3397015290	4040EC
18"/18"	3397015287	4545EC
19"/17"	3397015294	4742EC
19"/19"	3397015296	4747EC
20"/20"	3397015292	5050EC
21"/19"	3397015288	5347EC
21"/21"	3397015295	5353EC
22"/22"	3397015289	5555EC
22"/15"	3397015297	5538EC
24"/24"	3397015293	6060EC

ECO Traseras		
Pulgadas	Nº de Parte	Nº Corto
10"	3 397 011 593	10E
12"	3 397 011 594	12E
13"	3 397 011 595	13E
14"	3 397 011 596	14E
15"	3 397 011 597	15E
16"	3 397 011 598	16E

TRASERAS Especiales		
Pulgadas	Nº de Parte	Nº Corto
10"	3397008056	A250H
11"	3397013741	A275H
11"	3397008005	A280H
11"	3397008045	A281H
11"	3397008634	A282H
12"	3397016271	A300H
12"	3397013049	A310H
13"	3397008006	A330H
13"	3397008635	A332H
13"	3397016387	A334H
14"	3397008192	A351H
14"	3397008997	A360H
15"	3397008050	A380H
15"	3397008996	A381H
15"	3397016087	A383H
16"	3397008047	A401H
16"	3397008057	A402H
17"	3397008051	A425H
7"	3397011963	H180
8"	3397011964	H200
9"	3397004560	H230
10"	3397011677	H240
10"	3397011629	H250
10"	3397011813	H251
10"	3397011965	H252
10"	3397005828	H253
11"	3397015302	H275
11"	3397011428	H281
12"	3397011814	H290
12"	3397004628	H300
12"	3397004629	H301
12"	3397004990	H304
12"	3397011239	H305
12"	3397011432	H306
12"	3397011429	H307
12"	3397015131	H307F
12"	3397011628	H308
12"	3397011630	H309
12"	3397011678	H312
13"	3397015107	H326
14"	3397004559	H351
14"	3397011430	H352
14"	3397004631	H353
14"	3397011433	H354
14"	3397011435	H355
15"	3397011022	H370
16"	3397004632	H402
16"	3397011431	H409
16"	3397011434	H410
15"	3397004753	H753
14"	3397004772	H772
12"	3397004802	H840
14"	3397004874	H874

Vanguardia, alta tecnología, desempeño, claridad, visibilidad, seguridad total.



		Ubicación	Pluma Plana		Convencional		Traseras Especiales
			ICON	Clear Advantage	ECO	ECO Set	
Acura							
ILX							
2018-13	Frontal Conductor	26A	26CA	65EC			
	Frontal Pasajero	19A	19CA	48EC			
MDX							
2019-14	Frontal Conductor	26A	26CA	65EC			
	Frontal Pasajero	20B	20CA	50EC			
	Trasera						H354
2013-07	Frontal Conductor	26A	26CA	65EC			
	Frontal Pasajero	21B	21CA	53EC			
	Trasera						H306
2006-05	Frontal Conductor	24A	24CA	60EC			
	Frontal Pasajero	21B	21CA	53EC			
	Trasera			45EC			
RDX							
2018-07	Frontal Conductor	26A	26CA	65EC			
	Frontal Pasajero	16A	16CA	40EC			
	Trasera						H354
RLX							
2015-14	Frontal Conductor	26A	26CA	65EC			
	Frontal Pasajero	19B	19CA	48EC			
TL							
2013-05	Frontal Conductor	24A	24CA	60EC			
	Frontal Pasajero	18B	18CA	45EC			
TLX							
2020-16	Frontal Conductor	26A	26CA	65EC			
	Frontal Pasajero	17B	17CA	42EC			
2015	Frontal Conductor	24A	24CA	60EC			
	Frontal Pasajero	17B	17CA	42EC			
TSX							
2013-09	Frontal Conductor	24A	24CA	60EC			
	Frontal Pasajero	22B	22CA	55EC			
ZDX							
2011-10	Frontal Conductor	26A	26CA	65EC			
	Frontal Pasajero	19B	19CA	48EC			
Alfa Romeo							
4C							
2017-16	Centro	22OE	22CA				
147							
2007	Frontal Conductor	22OE	22CA				
2005-02	Frontal Conductor	22A	22CA	55EC			
	Frontal Pasajero	16A	16CA	40EC			
156							
2004-02	Frontal Conductor	22A	22CA	55EC			
	Frontal Pasajero	20A	20CA	50EC			
159							
2012	Frontal Conductor	22OE	22CA				
	Frontal Pasajero	18OE	18CA				
2008-07	Frontal Conductor	22OE	22CA				
	Frontal Pasajero	18OE	18CA				
166							
2003-02	Frontal					5347EC	
	Frontal Conductor	21A	21CA	53EC			
	Frontal Pasajero	19A	19CA	48EC			
Brera							
2008-07	Frontal Conductor	22OE	22CA				
	Frontal Pasajero	18OE	18CA				
Giulia							
2019-17	Frontal Conductor	24OE	24CA				
	Frontal Pasajero	18OE	18CA				
Giulietta							
2019-12	Frontal Conductor	24OE	24CA				
	Frontal Pasajero	18OE	18CA				
GT							
2008-07	Frontal Conductor	22OE	22CA				
Mito							
2018-15	Frontal Conductor	26OE	26CA				
	Frontal Pasajero	15OE	15CA				
2013-12	Frontal Conductor	26OE	26CA				
	Frontal Pasajero	15OE	15CA				

A

		Ubicación	Pluma Plana		Convencional		Traseras Especiales
			ICON	Clear Advantage	ECO	ECO Set	
Alfa Romeo (cont'd.)							
Spider							
2008-07		Frontal Conductor	22OE	22CA			
		Frontal Pasajero	18OE	18CA			
Sportwagon							
2002		Frontal Conductor	22A	22CA	55EC		
		Frontal Pasajero	20A	20CA	50EC		
Stelvio							
2019-17		Frontal Conductor		26CA			
		Frontal Pasajero		18CA			
		Trasera					A310H
Audi							
A1							
2018-11		Frontal Conductor	24OE	24CA			
		Frontal Pasajero	15OE				
A3							
2019		Frontal Conductor	26OE	26CA			
	Convertible	Frontal Pasajero	18OE	18CA			
	Sedan	Frontal Pasajero	19OE	19CA			
2018		Frontal Conductor	26OE	26CA			
		Frontal Pasajero	18OE	18CA			
2017		Frontal Conductor	26OE	26CA			
	Hatchback	Frontal Pasajero	18OE	18CA			
		Trasera					A330H
2016-15	Sedan	Frontal Pasajero	19OE	19CA			
		Frontal Conductor	26OE	26CA			
	Convertible, Hatchback	Frontal Pasajero	18OE	18CA			
2014	Hatchback	Frontal Pasajero	19OE	19CA			
		Frontal Conductor	26OE	26CA			
		Trasera					A330H
2013-12	Sedan	Frontal Pasajero	19OE	19CA			
		Frontal Conductor	24OE	24CA			
	Convertible	Frontal Pasajero	18OE	18CA			
2011	Hatchback	Frontal Pasajero	19OE	19CA			
		Trasera					H772
		Frontal Conductor	24OE	24CA			
2010-09		Frontal Pasajero	19OE	19CA			
		Trasera					H772
	Convertible	Frontal Conductor	24OE	24CA			
2008-06	Hatchback	Frontal Pasajero	18OE	18CA			
		Frontal Pasajero	19OE	19CA			
		Trasera					H772
2005-04		Frontal Conductor	24OE	24CA			
		Frontal Pasajero	19OE	19CA			
		Trasera					H772
2003-98		Frontal Conductor	24OE	24CA			
		Frontal Pasajero	19OE	19CA			
		Trasera					H772
2003-98		Frontal				5347EC	
		Frontal Conductor	21A	21CA	53EC		
		Frontal Pasajero	19A	19CA	48EC		
A3 Quattro							
2011		Frontal Conductor	24OE	24CA			
		Frontal Pasajero	19OE	19CA			
		Trasera					H772
2008-06		Frontal Conductor	24OE	24CA			
		Frontal Pasajero	19OE	19CA			
		Trasera					H772
2005		Frontal Conductor	24OE	24CA			
		Frontal Pasajero	19OE	19CA			
A4							
2019-09		Frontal Conductor	24OE	24CA			
		Frontal Pasajero	20OE	20CA			
A4 Quattro							
2019-10		Frontal Conductor	24OE	24CA			
		Frontal Pasajero	20OE	20CA			
A5							
2018		Frontal Conductor	24OE	24CA			
		Frontal Pasajero	20OE	20CA			
2016-15		Frontal Conductor	24OE	24CA			
		Frontal Pasajero	20OE	20CA			

A



		Ubicación	Pluma Plana		Convencional		Traseras Especiales
			ICON	Clear Advantage	ECO	ECO Set	
Audi (cont'd.)							
A5 (cont'd.)							
2014-12		Frontal Conductor	24OE	24CA			
	Convertible	Frontal Pasajero	21OE	21CA			
2011-08	Coupe, Hatchback	Frontal Pasajero	20OE	20CA			
		Frontal Conductor	24OE	24CA			
		Frontal Pasajero	20OE	20CA			
A5 Quattro							
2015-12		Frontal Conductor	24OE	24CA			
		Frontal Pasajero	20OE	20CA			
2011		Frontal Conductor	24OE	24CA			
	Convertible	Frontal Pasajero	21OE	21CA			
2008	Coupe	Frontal Pasajero	20OE	20CA			
		Frontal Conductor	24OE	24CA			
		Frontal Pasajero	20OE	20CA			
A5 Sportback							
2019		Frontal Conductor	24OE	24CA			
		Frontal Pasajero	20OE	20CA			
A6							
2018		Frontal Conductor, Solo vehículos de de pasajeros sin water jet en la pluma	26OE	26CA			
		Frontal Pasajero, Solo vehículos de de pasajeros sin water jet en la pluma	21OE	21CA			
2017-16		Frontal Conductor	26OE	26CA			
		Frontal Pasajero	21OE	21CA			
2014-12		Frontal Conductor	26OE	26CA			
		Frontal Pasajero	21OE	21CA			
2000-99		Frontal Conductor	22A	22CA	55EC		
	Sedan	Frontal Pasajero	22A	22CA	55EC	5555EC	
1998	Wagon	Frontal Pasajero	20A	20CA	50EC		
		Frontal	22A	22CA	55EC	5555EC	
A6 Quattro							
2019-18		Frontal Conductor, Solo vehículos de de pasajeros sin water jet en la pluma	26OE	26CA			
		Frontal Pasajero, Solo vehículos de de pasajeros sin water jet en la pluma	21OE	21CA			
2017		Frontal Conductor	26OE	26CA			
		Frontal Pasajero	21OE	21CA			
2014-12		Frontal Conductor	26OE	26CA			
		Frontal Pasajero	21OE	21CA			
2000-98		Frontal	22A	22CA	55EC	5555EC	
A7							
2017-16		Frontal Conductor	24OE	24CA			
		Frontal Pasajero	21OE	21CA			
A7 Quattro							
2018-17		Frontal Conductor	24OE	24CA			
		Frontal Pasajero	21OE	21CA			
2014-12		Frontal Conductor	24OE	24CA			
		Frontal Pasajero	21OE	21CA			
A8							
2016-15		Frontal Conductor	26OE	26CA			
		Frontal Pasajero	20OE	20CA			
2000		Frontal Conductor	22A	22CA	55EC		
		Frontal Pasajero	20A	20CA	50EC		
A8 Quattro							
2017		Frontal Conductor	26OE	26CA			
		Frontal Pasajero	20OE	20CA			
2015-12		Frontal Conductor	26OE	26CA			
		Frontal Pasajero	20OE	20CA			
2002-97		Frontal Conductor	22A	22CA	55EC		
		Frontal Pasajero	20A	20CA	50EC		
Cabriolet							
1998-97		Frontal	22A	22CA	55EC	5555EC	
Q2							
2019-18		Frontal Conductor	24OE	24CA			
		Frontal Pasajero	19OE	19CA			
		Trasera					A332H

A

		Ubicación	Pluma Plana		Convencional		Traseras Especiales
			ICON	Clear Advantage	ECO	ECO Set	
Audi (cont'd.)							
Q2 Quattro							
2018		Frontal Conductor	24OE	24CA			
		Frontal Pasajero	19OE	19CA			
		Trasera					A332H
Q3							
2018-15		Frontal Conductor	24OE	24CA			
		Frontal Pasajero	21OE	21CA			
		Trasera					A402H
2014-13		Frontal Conductor	24OE	24CA			
		Frontal Pasajero	20OE	20CA			
Q3 Quattro							
2018-17		Frontal Conductor	24OE	24CA			
		Frontal Pasajero	21OE	21CA			
		Trasera					A402H
Q5							
2019-13		Frontal Conductor	24OE	24CA			
		Frontal Pasajero	20OE	20CA			
		Trasera					A332H
Q7							
2019-16		Frontal Conductor		28CA			
		Frontal Pasajero	20OE	20CA			
		Trasera					A360H
2015-07		Frontal Conductor	26OE	26CA			
		Frontal Pasajero	24OE	24CA			
		Trasera					H772
RS3							
2018		Frontal Conductor	26OE	26CA			
		Frontal Pasajero	18OE	18CA			
RS5							
2019-18		Frontal Conductor	24OE	24CA			
		Frontal Pasajero	20OE	20CA			
2016-13		Frontal Conductor	24OE	24CA			
		Frontal Pasajero	20OE	20CA			
2011		Frontal Conductor	24OE	24CA			
		Frontal Pasajero	20OE	20CA			
RS6							
2004		Frontal Conductor	22A	22CA	55EC		
		Frontal Pasajero	21A	21CA	53EC		
RS7							
2018-15		Frontal Conductor	24OE	24CA			
		Frontal Pasajero	21OE	21CA			
RS Q3							
2018-17		Frontal Conductor	24OE	24CA			
		Frontal Pasajero	21OE	21CA			
		Trasera					A402H
S3							
2019-18		Frontal Conductor	26OE	26CA			
		Frontal Pasajero	18OE	18CA			
2017-15	Hatchback	Frontal Conductor	26OE	26CA			
		Frontal Pasajero	18OE	18CA			
		Trasera					A330H
2014	Sedan	Frontal Pasajero	19OE	19CA			
		Frontal Conductor	26OE	26CA			
		Frontal Pasajero	18OE	18CA			
2012-08		Trasera					A330H
	Frontal Conductor	24OE	24CA				
	Frontal Pasajero	19OE	19CA				
2004-00		Trasera					H772
	Frontal				5347EC		
	Frontal Conductor	21A	21CA	53EC			
	Frontal Pasajero	19A	19CA	48EC			
S4							
2016-10		Frontal Conductor	24OE	24CA			
		Frontal Pasajero	20OE	20CA			
S5							
2016		Frontal Conductor	24OE	24CA			
		Frontal Pasajero	20OE	20CA			
2014-08		Frontal Conductor	24OE	24CA			
		Frontal Pasajero	20OE	20CA			

A



		Ubicación	Pluma Plana		Convencional		Traseras Especiales
			ICON	Clear Advantage	ECO	ECO Set	
Audi (cont'd.)							
S6							
2018		Frontal Conductor, Solo vehículos de de pasajeros sin water jet en la pluma	26OE	26CA			
		Frontal Pasajero, Solo vehículos de de pasajeros sin water jet en la pluma	21OE	21CA			
2017-16		Frontal Conductor	26OE	26CA			
		Frontal Pasajero	21OE	21CA			
2014		Frontal Conductor	26OE	26CA			
		Frontal Pasajero	21OE	21CA			
2004-01		Frontal Conductor	22A	22CA	55EC		
		Frontal Pasajero	21A	21CA	53EC		
S7							
2018-16		Frontal Conductor	24OE	24CA			
		Frontal Pasajero	21OE	21CA			
2014-13		Frontal Conductor	24OE	24CA			
		Frontal Pasajero	21OE	21CA			
S8							
2017-13		Frontal Conductor	26OE	26CA			
		Frontal Pasajero	20OE	20CA			
2002-01		Frontal		22CA	55EC	5555EC	
		Frontal Conductor	22A				
		Frontal Pasajero	22B				
SQ5							
2017		Frontal Conductor	24OE	24CA			
		Frontal Pasajero	20OE	20CA			
		Trasera					A332H
TT							
2018-16		Frontal Conductor	24OE	24CA			
		Frontal Pasajero	21OE	21CA			
2014-07		Frontal Conductor	22OE	22CA			
		Frontal Pasajero	21OE	21CA			
2006-04		Frontal	21OE	21CA			
2003-00		Frontal		21CA	53EC	5353EC	
		Frontal Conductor	21A				
		Frontal Pasajero	21B				
1999		Frontal Conductor	22OE	22CA			
		Frontal Pasajero	21OE	21CA			
TT Quattro							
2018-17		Frontal Conductor	24OE	24CA			
		Frontal Pasajero	21OE	21CA			
2014		Frontal Conductor	22OE	22CA			
		Frontal Pasajero	21OE	21CA			
2006-04	Convertible	Frontal	21OE	21CA			
2003	Convertible	Frontal		21CA	53EC	5353EC	
		Frontal Conductor	21A				
		Frontal Pasajero	21B				
2002-01		Frontal		21CA	53EC	5353EC	
		Frontal Conductor	21A				
		Frontal Pasajero	21B				
TT RS Quattro							
2014-11		Frontal Conductor	22OE	22CA			
		Frontal Pasajero	21OE	21CA			
TTS Quattro							
2017		Frontal Conductor	24OE	24CA			
		Frontal Pasajero	21OE	21CA			
2014-11		Frontal Conductor	22OE	22CA			
		Frontal Pasajero	21OE	21CA			
2010	Coupe	Frontal Conductor	22OE	22CA			
		Frontal Pasajero	21OE	21CA			
Bentley							
Flying Spur							
2013		Frontal		22CA	55EC	5555EC	
		Frontal Conductor	22A				
		Frontal Pasajero	22B				

**A
B**



			Pluma Plana		Convencional		Traseras Especiales
Ubicación			ICON	Clear Advantage	ECO	ECO Set	
BMW							
1 Series							
2019	Hatchback	Frontal Conductor	22OE	22CA			
		Frontal Pasajero	18OE	18CA			
		Trasera					H306
2018-14		Frontal Conductor	22OE	22CA			
		Frontal Pasajero	18OE	18CA			
		Trasera					H306
2013		Frontal	20OE	20CA			
		Frontal Conductor	22OE	22CA			
		Frontal Pasajero	18OE	18CA			
		Trasera					H306
2012		Frontal	20OE	20CA			
		Frontal Conductor	22OE	22CA			
		Frontal Pasajero	18OE	18CA			
		Trasera					H306
	Coupe	Frontal	20OE	20CA			
		Frontal Conductor	22OE	22CA			
		Frontal Pasajero	18OE	18CA			
Hatchback	Frontal Conductor	22OE	22CA				
	Frontal Pasajero	18OE	18CA				
2011		Frontal Conductor	22OE	22CA			
		Frontal Pasajero	18OE	18CA			
		Trasera					H306
2010-05	Coupe	Frontal	20OE	20CA			
		Frontal	20OE	20CA			
		Trasera					A280H
2 Series							
2019	Wagon	Frontal Conductor	22OE	22CA			
		Frontal Pasajero	18OE	18CA			
2018-14		Frontal Conductor	22OE	22CA			
		Frontal Pasajero	18OE	18CA			
3 Series							
2020-14	Sedan	Frontal Conductor	24OE	24CA			
		Frontal Pasajero	19OE	19CA			
2013	Convertible	Frontal Conductor	24OE	24CA			
		Frontal Pasajero	17OE	17CA			
		Frontal Pasajero	19OE	19CA			
	Coupe	Frontal Conductor	24OE	24CA			
		Frontal Pasajero	15OE	15CA			
		Frontal Pasajero	17OE	17CA			
Sedan	Frontal Pasajero	19OE	19CA				
	Frontal Conductor	24OE	24CA				
	Frontal Pasajero	19OE	19CA				
	Frontal Pasajero	19OE	19CA				
2012	Convertible	Frontal Conductor	24OE	24CA			
		Frontal Pasajero	17OE	17CA			
		Frontal Pasajero	19OE	19CA			
	Coupe	Frontal Conductor	24OE	24CA			
		Frontal Pasajero	15OE	15CA			
		Frontal Pasajero	17OE	17CA			
	Sedan	Frontal Pasajero	19OE	19CA			
		Frontal Conductor	24OE	24CA			
		Frontal Pasajero	19OE	19CA			
		Frontal Pasajero	19OE	19CA			
Wagon	Frontal Conductor	24OE	24CA				
	Frontal Pasajero	19OE	19CA				
2011	Convertible	Frontal Conductor	24OE	24CA			
		Frontal Pasajero	19OE	19CA			
	Coupe	Frontal Conductor	24OE	24CA			
		Frontal Pasajero	15OE	15CA			
	Sedan	Frontal Conductor	24OE	24CA			
		Frontal Pasajero	19OE	19CA			
2010	Convertible	Frontal Conductor	24OE	24CA			
		Frontal Pasajero	19OE	19CA			
	Coupe	Frontal Conductor	24OE	24CA			
		Frontal Pasajero	19OE	19CA			
	Sedan	Frontal Conductor	24OE	24CA			
		Frontal Pasajero	19OE	19CA			
2009	Sedan	Frontal Conductor	24OE	24CA			
		Frontal Pasajero	19OE	19CA			
2007	Convertible	Frontal Conductor	24OE ¹³				
		Frontal Pasajero	19OE ¹³				
	Coupe	Frontal Conductor	24OE ¹³				
		Frontal Pasajero	19OE ¹³				
	Sedan	Frontal Conductor	24OE ¹³				
		Frontal Pasajero	19OE ¹³				

B



			Pluma Plana		Convencional		
Ubicación			ICON	Clear Advantage	ECO	ECO Set	Traseras Especiales
BMW (cont'd.)							
3 Series (cont'd.)							
2006-01	Convertible	Frontal Conductor	22A ¹³	22CA ¹³	55EC ¹³		
		Frontal Pasajero	19B ¹³	19CA ¹³	48EC ¹³		
	Coupe	Frontal Conductor	22A ¹³	22CA ¹³	55EC ¹³		
		Frontal Pasajero	19B ¹³	19CA ¹³	48EC ¹³		
2000	Sedan	Frontal	20A	20CA	50EC	5050EC	
		Frontal Conductor	22A ¹³	22CA ¹³	55EC ¹³		
1999		Frontal Pasajero	19B ¹³	19CA ¹³	48EC ¹³		
		Frontal	20A	20CA	50EC	5050EC	
1998	Convertible	Frontal Conductor	21A ¹³	21CA ¹³	53EC ¹³		
		Frontal Pasajero	20A	20CA ¹³	50EC ¹³		
	Sedan	Frontal Pasajero	20B ¹³	20CA ¹³	50EC ¹³		
		Frontal Conductor	21A ¹³	21CA ¹³	53EC ¹³		
1997-95	Convertible	Frontal Pasajero	20A	20CA ¹³	50EC ¹³		
		Frontal Conductor	21A	21CA	53EC		
	Sedan	Frontal Pasajero	20B ¹³	20CA ¹³	50EC ¹³		
		Frontal Conductor	21A	21CA	53EC		
		Frontal Pasajero	20B	20CA	50EC		
		Frontal Pasajero	20B	20CA	50EC		
4 Series							
2019-18		Frontal Conductor	24OE	24CA			
		Frontal Pasajero	18OE	18CA			
2017		Frontal Conductor	24OE	24CA			
		Frontal Pasajero	18OE	18CA			
	Convertible	Frontal Conductor	24OE	24CA			
		Frontal Pasajero	18OE	18CA			
	Coupe	Frontal Conductor	24OE	24CA			
		Frontal Pasajero	18OE	18CA			
2016-14		Frontal Conductor	24OE	24CA			
		Frontal Pasajero	18OE	18CA			
5 Series							
2019-18		Frontal Conductor	26OE	26CA			
		Frontal Pasajero	19OE	19CA			
2016-11		Frontal Conductor	26OE				
		Frontal Pasajero	18OE				
2010		Frontal Conductor	24OE	24CA			
		Frontal Pasajero	22OE	22CA			
2009-04		Trasera					H753
		Frontal Conductor	24OE	24CA			
		Frontal Pasajero	22OE	22CA			
		Frontal Pasajero	22OE	22CA			
6 Series							
2018		Frontal Conductor	26OE				
		Frontal Pasajero	17OE				
2017	Coupe	Frontal Conductor	26OE				
		Frontal Pasajero	17OE				
2016-15		Frontal Conductor	26OE				
		Frontal Pasajero	17OE				
2014	Convertible	Frontal Conductor	26OE				
		Frontal Pasajero	17OE				
	Coupe	Frontal Conductor	26OE				
		Frontal Pasajero	17OE				
2013-12		Frontal Conductor	26OE				
		Frontal Pasajero	17OE				
2011	Coupe	Frontal Conductor	24OE	24CA			
		Frontal Pasajero	22OE	22CA			
2010-05		Frontal Conductor	24OE	24CA			
		Frontal Pasajero	22OE	22CA			
7 Series							
2019-17		Frontal Conductor	26OE	26CA			
		Frontal Pasajero	19OE	19CA			
2016		Frontal Conductor	26OE	26CA			
		Frontal Pasajero	18OE	18CA			
		Frontal Conductor	19OE	19CA			
		Frontal Pasajero	26OE				
2015-11		Frontal Conductor	26OE				
		Frontal Pasajero	19OE				
2010		Frontal Conductor	26OE				
		Frontal Pasajero	18OE				
2009		Frontal Conductor	26OE				
		Frontal Pasajero	19OE				
ActiveHybrid 3							
2015-14		Frontal Conductor	24OE	24CA			
		Frontal Pasajero	19OE	19CA			



		Ubicación	Pluma Plana		Convencional		Traseras Especiales
			ICON	Clear Advantage	ECO	ECO Set	
BMW (cont'd.)							
ActiveHybrid 5							
2015-14		Frontal Conductor	26OE				
		Frontal Pasajero	18OE				
i3 Series							
2019		Frontal Conductor	28AOE	28CA			
		Frontal Pasajero	21OE	21CA			
		Trasera					H840
2017-15		Frontal Conductor	28AOE	28CA			
		Frontal Pasajero	21OE	21CA			
		Trasera					H840
i8							
2018-15		Frontal Conductor	28AOE	28CA			
		Frontal Pasajero	24OE	24CA			
M2 Series							
2019-15		Frontal Conductor	22OE	22CA			
		Frontal Pasajero	18OE	18CA			
M3							
2018-15	Sedan	Frontal Conductor	24OE	24CA			
		Frontal Pasajero	19OE	19CA			
2012-11	Convertible	Frontal Conductor	24OE	24CA			
		Frontal Pasajero	17OE	17CA			
	Coupe	Frontal Conductor	24OE	24CA			
		Frontal Pasajero	17OE	17CA			
2010	Sedan	Frontal Conductor	24OE	24CA			
		Frontal Pasajero	19OE	19CA			
	Convertible	Frontal Conductor	24OE	24CA			
		Frontal Pasajero	17OE	17CA			
2009-08	Coupe	Frontal Conductor	24OE	24CA			
		Frontal Pasajero	17OE	17CA			
	Sedan	Frontal Conductor	24OE ¹³	24CA ¹³			
		Frontal Pasajero	17OE ¹³	17CA ¹³			
2006-01	Convertible	Frontal Conductor	22A ¹³	19CA ¹³	55EC ¹³		
		Frontal Pasajero	19B ¹³	19CA ¹³	48EC ¹³		
	Coupe	Frontal Conductor	22A ¹³	22CA ¹³	55EC ¹³		
		Frontal Pasajero	19B ¹³	19CA ¹³	48EC ¹³		
1999	Convertible	Frontal Conductor	22A ¹³	22CA ¹³	55EC ¹³		
		Frontal Pasajero	19B ¹³	19CA ¹³	48EC ¹³		
	Coupe	Frontal Conductor	22A ¹³	22CA ¹³	55EC ¹³		
		Frontal Pasajero	19B ¹³	19CA ¹³	48EC ¹³		
1998	Convertible	Frontal Conductor	21A	21CA	53EC		
		Frontal Pasajero	20B	20CA	50EC		
	Coupe	Frontal Conductor	21A	21CA	53EC		
		Frontal Pasajero	20B	20CA	50EC		
1997	Sedan	Frontal Conductor	21A	21CA	53EC		
		Frontal Pasajero	20B	20CA	50EC		
	Coupe	Frontal Conductor	21A	21CA	53EC		
		Frontal Pasajero	20B	20CA	50EC		
1996-95	Coupe	Frontal Conductor	21A	21CA	53EC		
		Frontal Pasajero	20B	20CA	50EC		
M4							
2019-15		Frontal Conductor	24OE	24CA			
		Frontal Pasajero	18OE	18CA			
M5 Series							
2019		Frontal Conductor	26OE	26CA			
		Frontal Pasajero	19OE	19CA			
2016-12		Frontal Conductor	26OE				
		Frontal Pasajero	18OE				
2010-06		Frontal Conductor	24OE	24CA			
		Frontal Pasajero	22OE	22CA			
1999		Frontal Conductor	24OE	24CA			
		Frontal Pasajero	18OE	18CA			
M6 Series							
2017	Coupe	Frontal Conductor	26OE				
		Frontal Pasajero	17OE				

B

		Ubicación	Pluma Plana		Convencional		Traseras Especiales
			ICON	Clear Advantage	ECO	ECO Set	
BMW (cont'd.)							
M6 Series (cont'd.)							
2016-15		Frontal Conductor	26OE				
		Frontal Pasajero	17OE				
2014		Frontal Conductor	26OE				
		Frontal Pasajero	17OE				
	Convertible	Frontal Conductor	26OE				
		Frontal Pasajero	17OE				
	Coupe	Frontal Conductor	26OE				
		Frontal Pasajero	17OE				
2011		Frontal Conductor	24OE	24CA			
	Convertible	Frontal Pasajero	22OE	22CA			
	Coupe	Frontal Pasajero	18OE	18CA			
2010-06		Frontal Conductor	24OE	24CA			
		Frontal Pasajero	22OE	22CA			
M7 Series							
2019-18		Frontal Conductor	26OE	26CA			
		Frontal Pasajero	19OE	19CA			
M135i							
2016-14		Frontal Conductor	22OE	22CA			
		Frontal Pasajero	18OE	18CA			
		Trasera					H306
2013		Frontal Conductor	22OE	22CA			
		Frontal Pasajero	18OE	18CA			
M140i							
2019-17		Frontal Conductor	22OE	22CA			
		Frontal Pasajero	18OE	18CA			
		Trasera					H306
X1							
2019-16		Frontal Conductor	26OE	26CA			
		Frontal Pasajero		16CA			
		Trasera					A332H
2015		Frontal Conductor	24OE	24CA			
		Frontal Pasajero	18OE	18CA			
		Trasera					A334H
2014	SUV	Frontal Conductor	24OE	24CA			
		Frontal Pasajero	18OE	18CA			
		Trasera					A334H
2013-10		Frontal Conductor	24OE	24CA			
		Frontal Pasajero	18OE	18CA			
		Trasera					A334H
X2							
2019		Trasera					A332H
X3							
2019-18		Trasera					A281H
2017-11		Frontal Conductor	26OE	26CA			
		Frontal Pasajero	20OE	20CA			
		Trasera					A330H
2010-07		Frontal Conductor	22A	22CA	55EC		
		Frontal Pasajero	20B	20CA	50EC		
		Trasera					H351
X4							
2018-15		Frontal Conductor	26OE	26CA			
		Frontal Pasajero	20OE	20CA			
X5							
2018-14		Frontal Conductor	24A	24CA	60EC		
		Frontal Pasajero	20B	20CA	50EC		
		Trasera					H306
2013-09		Frontal Conductor	24OE	24CA			
		Frontal Pasajero	20OE	20CA			
		Trasera					A380H
2006-00		Frontal Conductor	24A	24CA	60EC		
		Frontal Pasajero	22B	22CA	55EC		
		Trasera			42EC		
X6							
2019-16		Frontal Conductor	24A	24CA	60EC		
		Frontal Pasajero	20A	20CA	50EC		
2015-09		Frontal Conductor	24OE	24CA			
		Frontal Pasajero	20OE	20CA			
Z3							
2002-99		Frontal		20CA	50EC	5050EC	
		Frontal Conductor	20A				
		Frontal Pasajero	20B				



		Ubicación	Pluma Plana		Convencional		Traseras Especiales
			ICON	Clear Advantage	ECO	ECO Set	
BMW (cont'd.)							
Z3 (cont'd.)							
2002-99	Coupe	Trasera					H281
1998-96		Frontal		20CA	50EC	5050EC	
		Frontal Conductor	20A				
		Frontal Pasajero	20B				
Z4							
2009	Coupe	Frontal Conductor	21A	21CA	53EC		
		Frontal Pasajero	20B	20CA	50EC		
2008-06		Frontal Conductor	21A	21CA	53EC		
		Frontal Pasajero	20B	20CA	50EC		
Z8							
2003-01		Frontal		21CA	53EC	5353EC	
		Frontal Conductor	21A				
		Frontal Pasajero	21B				
Buick							
Century							
1996-83		Frontal		18CA	45EC	4545EC	
Enclave							
2020		Frontal Conductor	24A	24CA	60EC		
		Frontal Pasajero	20A	20CA	50EC		
2019-18		Frontal Conductor	24A	24CA	60EC		
		Frontal Pasajero	20A	20CA	50EC		
		Trasera					H251
2017-10		Frontal Conductor	24OE	24CA			
		Frontal Pasajero	21OE	21CA			
		Trasera					H300
Encore							
2019-14		Frontal Conductor	26OE	26CA			
		Frontal Pasajero	13OE	13CA			
		Trasera					H251
Envision							
2020-16		Frontal Conductor	24A	24CA	60EC		
		Frontal Pasajero	18A	18CA	45EC		
LaCrosse							
2011-10		Frontal Conductor	26A	26CA	65EC		
		Frontal Pasajero	18B	18CA	45EC		
Regal							
2017-13		Frontal Conductor	24A	24CA	60EC		
		Frontal Pasajero	18B	18CA	45EC		
1996-94		Frontal		20CA			
Verano							
2016-14		Frontal Conductor	26OE	26CA			
		Frontal Pasajero	24OE	24CA			
Cadillac							
ATS							
2019-13		Frontal Conductor	22B	22CA	55EC		
		Frontal Pasajero	18B	18CA	45EC		
BLS							
2008-07		Frontal Conductor	24OE	24CA			
		Frontal Pasajero	22OE	22CA			
Catera							
2001-97		Frontal Conductor	24A	24CA	60EC		
		Frontal Pasajero	19B	19CA	48EC		
CTS							
2019-15		Frontal Conductor	24OE	24CA			
		Frontal Pasajero	18OE	18CA			
2014	Coupe	Frontal Conductor	22A	22CA	55EC		
		Frontal Pasajero	19A	19CA	48EC		
	Sedan	Frontal Conductor	24OE	24CA			
		Frontal Pasajero	18OE	18CA			
2013-08		Frontal Conductor	22A	22CA	55EC		
		Frontal Pasajero	19A	19CA	48EC		
2007-03		Frontal Conductor	22A	22CA	55EC		
		Frontal Pasajero	21B	21CA	53EC		
DeVille							
2004-91		Frontal		22CA	55EC	5555EC	
Eldorado							
1997-95		Frontal		22CA	55EC	5555EC	
1994		Frontal		22CA ¹	55EC ¹	5555EC ¹	

**B
C**



	Ubicación	Pluma Plana		Convencional		Traseras Especiales
		ICON	Clear Advantage	ECO	ECO Set	
Cadillac (cont'd.)						
Escalade						
2020	Frontal	22A	22CA	55EC	5555EC	
2019-15	Frontal	22A	22CA	55EC	5555EC	
	Trasera			34EC		
2014-09	Frontal		22CA	55EC	5555EC	
	Frontal Conductor	22A				
	Frontal Pasajero	22B				
	Trasera					H300
2008	Frontal, Última producción		22CA	55EC	5555EC	
	Frontal, Producción temprana	22OE	22CA			
	Frontal Conductor, Última producción	22A				
	Frontal Pasajero, Última producción	22B				
	Trasera					H300
2007	Frontal, Producción temprana		22CA	55EC	5555EC	
	Frontal, Última producción	22OE	22CA			
	Frontal Conductor, Producción temprana	22A				
	Frontal Pasajero, Producción temprana	22B				
	Trasera, Última producción					H300
	Trasera, Producción temprana			40EC		
2006-02	Frontal		22CA	55EC	5555EC	
	Frontal Conductor	22A				
	Frontal Pasajero	22B				
	Trasera			40EC		
Escalade ESV						
2020	Frontal	22A	22CA	55EC	5555EC	
2019-15	Frontal	22A	22CA	55EC	5555EC	
	Trasera			34EC		
2014-09	Frontal		22CA	55EC	5555EC	
	Frontal Conductor	22A				
	Frontal Pasajero	22B				
	Trasera					H300
2008	Frontal, Última producción		22CA	55EC	5555EC	
	Frontal, Producción temprana	22OE	22CA			
	Frontal Conductor, Última producción	22A				
	Frontal Pasajero, Última producción	22B				
	Trasera					H300
2007	Frontal, Producción temprana		22CA	55EC	5555EC	
	Frontal, Última producción	22OE	22CA			
	Frontal Conductor, Producción temprana	22A				
	Frontal Pasajero, Producción temprana	22B				
	Trasera, Última producción					H300
	Trasera, Producción temprana			40EC		
2006-03	Frontal		22CA	55EC	5555EC	
	Frontal Conductor	22A				
	Frontal Pasajero	22B				
	Trasera			40EC		
Escalade EXT						
2013-09	Frontal		22CA	55EC	5555EC	
	Frontal Conductor	22A				
	Frontal Pasajero	22B				
2008	Frontal, Última producción		22CA	55EC	5555EC	
	Frontal, Producción temprana	22OE	22CA			
	Frontal Conductor, Última producción	22A				
	Frontal Pasajero, Última producción	22B				
2007	Frontal	22OE	22CA			



		Ubicación	Pluma Plana		Convencional		Traseras Especiales
			ICON	Clear Advantage	ECO	ECO Set	
Cadillac (cont'd.)							
Escalade EXT (cont'd.)							
2006-02		Frontal		22CA	55EC	5555EC	
		Frontal Conductor	22A				
		Frontal Pasajero	22B				
Seville							
2004-03		Frontal		22CA ¹	55EC ¹	5555EC ¹	
		Frontal Conductor	22A ¹				
		Frontal Pasajero	22B ¹				
2000-94		Frontal		22CA ¹	55EC ¹	5555EC ¹	
SRX							
2016-10		Frontal Conductor	26OE	26CA			
		Frontal Pasajero	17OE	17CA			
2006-04		Frontal Conductor	22A	22CA	55EC		
		Frontal Pasajero	21B	21CA	53EC		
		Trasera			34EC		
STS							
2010-05		Frontal Conductor	22OE	22CA			
		Frontal Pasajero	21OE	21CA			
XLR							
2006-04		Frontal		20CA	50EC	5050EC	
		Frontal Conductor	20A				
		Frontal Pasajero	20B				
XT5							
2019-17		Frontal Conductor	24A	24CA	60EC		
		Frontal Pasajero	20A	20CA	50EC		
Chevrolet							
Astra							
2008		Frontal Conductor	22OE	22CA			
		Frontal Pasajero	18OE	18CA			
	Hatchback	Trasera					H840
2007		Frontal Conductor	22OE	22CA			
		Frontal Pasajero	18OE	18CA			
2006-04		Frontal Conductor	20A	20CA	50EC		
		Frontal Pasajero	18A	18CA	45EC		
2003-00		Frontal Conductor	20A	20CA	50EC		
		Frontal Pasajero	19A	19CA	48EC		
Avalanche							
2013-09		Frontal		22CA	55EC	5555EC	
		Frontal Conductor	22A				
		Frontal Pasajero	22B				
2008		Frontal, Última producción		22CA	55EC	5555EC	
		Frontal, Producción temprana	22OE	22CA			
		Frontal Conductor, Última producción	22A				
		Frontal Pasajero, Última producción	22B				
2007		Frontal	22OE	22CA			
2006-02		Frontal		22CA	55EC	5555EC	
		Frontal Conductor	22A				
		Frontal Pasajero	22B				
Aveo							
2017-12		Frontal Conductor	26OE	26CA			
		Frontal Pasajero	15OE	15CA			
2011-09		Frontal Conductor	22A	22CA	55EC		
		Frontal Pasajero	18B	18CA	45EC		
2008		Frontal Conductor	22A	22CA	55EC		
		Frontal Pasajero	19B	19CA	48EC		
Beat							
2020		Frontal Conductor	24A	24CA	60EC		
		Frontal Pasajero	13A	13CA	34EC		
2019	Hatchback	Frontal Conductor	24A	24CA	60EC		
		Frontal Pasajero	13A	13CA	34EC		
	Sedan	Frontal Conductor	24A	24CA	60EC		
		Frontal Pasajero	13A	13CA	34EC		
2018		Frontal Conductor	24A	24CA	60EC		
		Frontal Pasajero	13A	13CA	34EC		
Blazer (C, K Seies)							
2002-95		Frontal		20CA	50EC	5050EC	
		Frontal Conductor	20A				
		Frontal Pasajero	20B				
		Trasera			34EC		

1 Espacio entre el cofre y el parabrisas debe ser mínimo de 4 cm



C

			Pluma Plana		Convencional		Traseras Especiales
			ICON	Clear Advantage	ECO	ECO Set	
Ubicación							
Chevrolet (cont'd.)							
Blazer (S10)							
1993		Frontal		16CA	40EC	4040EC	
		Trasera			34EC		
Bolt EV							
2019-17		Frontal		26CA			
		Frontal Conductor	26OE				
C15							
1986-82		Frontal		18CA	45EC	4545EC	
C35							
2000-95		Frontal	18A	18CA	45EC	4545EC	
1987-83		Frontal		18CA	45EC	4545EC	
Camaro							
2019	Coupe	Frontal Conductor	22A	22CA	55EC		
		Frontal Pasajero	20B	20CA	50EC		
2018-16		Frontal Conductor	22A	22CA	55EC		
		Frontal Pasajero	20B	20CA	50EC		
2015-10		Frontal Conductor	24A	24CA	60EC		
		Frontal Pasajero	21B	21CA	53EC		
2002-98		Frontal	24A	24CA	60EC	6060EC	
Caprice							
1982-81	Sedan	Frontal		18CA	45EC	4545EC	
1980-79		Frontal		18CA	45EC	4545EC	
Captiva Sport							
2015-12		Frontal Conductor	24A	24CA	60EC		
		Frontal Pasajero	16A	16CA	40EC		
		Trasera					H308
2011-08		Frontal Conductor	24A	24CA	60EC		
		Frontal Pasajero	16A	16CA	40EC		
Cargo Van							
2004-03		Frontal	22A	22CA	55EC	5555EC	
Cavalier							
2004-95		Frontal Conductor	22A	22CA	55EC		
		Frontal Pasajero	17B	17CA	42EC		
1994-90		Frontal		16CA	40EC	4040EC	
Celebrity							
1989-82		Frontal		18CA	45EC	4545EC	
Chevy							
2006-04		Frontal Conductor	20A	20CA	50EC		
		Frontal Pasajero	18A	18CA	45EC		
2003-02		Frontal Pasajero	18A	18CA	45EC		
	Hatchback	Frontal Conductor	20A	20CA	50EC		
	Wagon	Frontal				4545EC	
		Frontal Conductor	18A	18CA	45EC		
2001		Frontal Pasajero	18A	18CA	45EC		
	Hatchback, Sedan	Frontal Conductor	20A	20CA	50EC		
	Wagon	Frontal				4545EC	
		Frontal Conductor	18A	18CA	45EC		
2000		Frontal Conductor	20A	20CA	50EC		
		Frontal Pasajero	18A	18CA	45EC		
1999-97		Frontal Pasajero	18A	18CA	45EC		
	Hatchback	Frontal				4545EC	
		Frontal Conductor	18A	18CA	45EC		
	Sedan	Frontal Conductor	20A	20CA	50EC		
1996-94		Frontal	18A	18CA	45EC	4545EC	
Chevy Monza							
2003		Frontal	18A	18CA	45EC	4545EC	
Chevy Pickup							
2003-99		Frontal Conductor	20A	20CA	50EC		
		Frontal Pasajero	18A	18CA	45EC		
Cheyenne							
2020-07		Frontal	22OE	22CA			
Citation							
1985-82		Frontal		18CA	45EC	4545EC	
Colorado							
2020-19		Frontal Conductor	22A	22CA	55EC		
		Frontal Pasajero	18A	18CA	45EC		



		Ubicación	Pluma Plana		Convencional		Traseras Especiales
			ICON	Clear Advantage	ECO	ECO Set	
Chevrolet (cont'd.)							
Colorado (cont'd.)							
2018		Frontal Conductor		22CA			
		Frontal Conductor, Desde Mar/2018	22A		55EC		
		Frontal Conductor, Hasta Feb/2018	22OE				
		Frontal Pasajero		18CA			
		Frontal Pasajero, Desde Mar/2018	18A		45EC		
	Frontal Pasajero, Hasta Feb/2018	18OE					
2017-15		Frontal Conductor	22OE	22CA			
		Frontal Pasajero	18OE	18CA			
2012-04		Frontal Conductor	22A	22CA	55EC		
		Frontal Pasajero	19B	19CA	48EC		
Corsa							
2008-02		Frontal Conductor	20A	20CA	50EC		
		Frontal Pasajero	18A	18CA	45EC		
Corvette							
2019-14		Frontal Conductor	22A	22CA	55EC		
		Frontal Pasajero	20A	20CA	50EC		
2013		Frontal	21A	21CA	53EC	5353EC	
2012-05		Frontal		21CA	53EC	5353EC	
		Frontal Conductor	21A				
		Frontal Pasajero	21B				
2004-99		Frontal		22CA	55EC	5555EC	
		Frontal Conductor	22A				
		Frontal Pasajero	22B				
1998-97	Hatchback	Frontal		22CA	55EC	5555EC	
		Frontal Conductor	22A				
		Frontal Pasajero	22B				
1996-95		Frontal		20CA	50EC	5050EC	
		Frontal					
Cruze							
2019-16		Frontal Conductor	28AOE	28CA			
		Frontal Pasajero	24OE	24CA			
2015-11		Frontal Conductor		24CA			
		Frontal Pasajero		18CA			
2010		Frontal Conductor	24A	24CA	60EC		
		Frontal Pasajero	18A	18CA	45EC		
Epica							
2009		Frontal Conductor	22A	22CA	55EC		
		Frontal Pasajero	20A	20CA	50EC		
Equinox							
2020-18		Frontal Conductor	24A	24CA	60EC		
		Frontal Pasajero	18A	18CA	45EC		
2017-16		Frontal Conductor	24OE	24CA			
		Frontal Pasajero	17OE	17CA			
		Trasera			34EC		
2008-05		Frontal Conductor	24A	24CA	60EC		
		Frontal Pasajero	19A	19CA	48EC		
		Trasera			38EC		
Express Cargo							
2020-09		Frontal	22A	22CA	55EC	5555EC	
Express Pasajeros							
2020-09		Frontal	22A	22CA	55EC	5555EC	
Serie G, Express							
2008-98		Frontal	22A	22CA	55EC	5555EC	
1995		Frontal		18CA	45EC	4545EC	
HHR							
2008-06		Frontal		18CA	45EC	4545EC	
		Frontal Conductor	18A				
		Frontal Pasajero	18B				
		Trasera					H281
Impala							
2003-00		Frontal		22CA	55EC	5555EC	
		Frontal Conductor	22A				
		Frontal Pasajero	22B				
1975	Coupe	Frontal		18CA	45EC	4545EC	
L30							
2000-99		Frontal	22A	22CA	55EC	5555EC	
Lumina Van							
1996-95		Frontal		24CA	60EC	6060EC	

C

		Ubicación	Pluma Plana		Convencional		Traseras Especiales
			ICON	Clear Advantage	ECO	ECO Set	
Chevrolet (cont'd.)							
LUV							
2005-99		Frontal Conductor	22A	22CA	55EC		
		Frontal Pasajero	19A	19CA	48EC		
1997		Frontal Conductor	22A	22CA	55EC		
		Frontal Pasajero	19A	19CA	48EC		
Malibu							
2019-16		Frontal Conductor	26A	26CA	65EC		
		Frontal Pasajero	18B	18CA	45EC		
2015-13		Frontal Conductor	24A	24CA	60EC		
		Frontal Pasajero	19B	19CA	48EC		
2012-08		Frontal Conductor	24OE	24CA			
		Frontal Pasajero	21OE	21CA			
2007-01		Frontal Conductor	22A	22CA	55EC		
		Frontal Pasajero	20B	20CA	50EC		
2000-97		Frontal Conductor	22A	22CA	55EC		
		Frontal Pasajero	19A	19CA	48EC		
1981-79		Frontal		18CA	45EC	4545EC	
1975		Frontal		16CA	40EC	4040EC	
Matiz							
2015-11		Frontal Conductor	22A	22CA	55EC		
		Frontal Pasajero	13A	13CA	34EC		
Meriva							
2008-04		Frontal Conductor	24A	24CA	60EC		
		Frontal Pasajero	22A	22CA	55EC		
Nova							
1978		Frontal	16A	16CA	40EC	4040EC	
1977-75	Hatchback	Frontal	16A	16CA	40EC	4040EC	
Optra							
2010-06		Frontal Conductor	22A	22CA	55EC		
		Frontal Pasajero	19A	19CA	48EC		
P30							
2002-01		Frontal	16A	16CA	40EC	4040EC	
1998-95		Frontal	18A	18CA	45EC	4545EC	
1994-92		Frontal		18CA	45EC	4545EC	
		Frontal Conductor	18A				
		Frontal Pasajero	18B				
Pickup (Serie C, K, R, V)							
2002		Frontal		22CA	55EC	5555EC	
		Frontal Conductor	22A				
		Frontal Pasajero	22B				
2001-99		Frontal		18CA	45EC	4545EC	
		Frontal Conductor	18A				
		Frontal Pasajero	18B				
1998-95		Frontal	18A	18CA	45EC	4545EC	
1994-87		Frontal		18CA	45EC	4545EC	
1986		Frontal			40EC	4040EC	
1982-75		Frontal			40EC	4040EC	
S10							
2003-95		Frontal		20CA	50EC	5050EC	
		Frontal Conductor	20A				
		Frontal Pasajero	20B				
1993-91		Frontal		16CA	40EC	4040EC	
Silverado							
2019		Frontal	22A	22CA	55EC	5555EC	
2018-08		Frontal	22OE	22CA			
2007		Frontal	22OE	22CA	55EC	5555EC	
		Frontal Conductor	22A				
		Frontal Pasajero	22B				
2006-01		Frontal		22CA	55EC	5555EC	
		Frontal Conductor	22A				
		Frontal Pasajero	22B				
1999-95		Frontal	18A	18CA	45EC	4545EC	
		Trasera			34EC		
Sonic							
2017-14		Frontal Conductor	26OE	26CA			
		Frontal Pasajero	15OE	15CA			
2013-12	Hatchback	Trasera					H240
		Frontal Conductor	26OE	26CA			
		Frontal Pasajero	15OE	15CA			

C

		Ubicación	Pluma Plana		Convencional		Traseras Especiales
			ICON	Clear Advantage	ECO	ECO Set	
Chevrolet (cont'd.)							
Sonora							
2006-03	Frontal			22CA	55EC	5555EC	
	Frontal Conductor	22A					
	Frontal Pasajero	22B					
	Trasera				40EC		
Spark							
2020	Frontal Conductor	24A	24CA	60EC			
	Frontal Pasajero	13A	13CA	34EC			
2019-16	Frontal Conductor	24A	24CA	60EC			
	Frontal Pasajero	13A	13CA	34EC			
	Trasera						H230
2015-13	Frontal Conductor	24OE	24CA				
	Frontal Pasajero	15OE	15CA				
2012-11	Frontal					5538EC	
	Frontal Conductor	22A	22CA	55EC			
	Frontal Pasajero	15A	15CA	38EC			
Spark Classic							
2017-16	Frontal					5538EC	
	Frontal Conductor	22A	22CA	55EC			
	Frontal Pasajero	15A	15CA	38EC			
Spark EV							
2015	Frontal Conductor	24OE	24CA				
	Frontal Pasajero	15OE	15CA				
Suburban							
2020	Frontal	22A	22CA	55EC	5555EC		
2019-15	Frontal	22A	22CA	55EC	5555EC		
	Trasera						H772
2014-09	Frontal		22CA	55EC	5555EC		
	Frontal Conductor	22A					
	Frontal Pasajero	22B					
2008	Trasera						H300
	Frontal, Última producción		22CA	55EC	5555EC		
	Frontal, Producción temprana	22OE	22CA				
	Frontal Conductor, Última producción	22A					
	Frontal Pasajero, Última producción	22B					
2007	Trasera						H300
	Frontal, Producción temprana		22CA	55EC	5555EC		
	Frontal, Última producción	22OE	22CA				
	Frontal Conductor, Producción temprana	22A					
	Frontal Pasajero, Producción temprana	22B					
	Trasera, Última producción						H300
	Trasera, Producción temprana			40EC			
2006-00	Frontal		22CA	55EC	5555EC		
	Frontal Conductor	22A					
	Frontal Pasajero	22B					
1999-95	Trasera			40EC			
	Frontal	18A	18CA	45EC	4545EC		
1994-88	Trasera			34EC			
	Frontal		18CA	45EC	4545EC		
1987	Frontal			40EC	4040EC		
Tahoe							
2020	Frontal	22A	22CA	55EC	5555EC		
2019-16	Frontal	22A	22CA	55EC	5555EC		
	Trasera			34EC			
	Frontal	22A	22CA	55EC	5555EC		
2015	Frontal		22CA	55EC	5555EC		
	Frontal Conductor	22A					
	Frontal Pasajero	22B					
	Trasera						H300
2008	Frontal, Última producción		22CA	55EC	5555EC		
	Frontal, Producción temprana	22OE	22CA				
	Frontal Conductor, Última producción	22A					
	Frontal Pasajero, Última producción	22B					

C



		Ubicación	Pluma Plana		Convencional		Traseras Especiales
			ICON	Clear Advantage	ECO	ECO Set	
Chevrolet (cont'd.)							
Tahoe (cont'd.)							
2008		Trasera					H300
2007		Frontal, Producción temprana		22CA	55EC	5555EC	
		Frontal, Última producción	22OE	22CA			
		Frontal Conductor, Producción temprana	22A				
		Frontal Pasajero, Producción temprana	22B				
		Trasera, Última producción					H300
		Trasera, Producción temprana			40EC		
Tigra							
1999		Frontal	18A	18CA	45EC	4545EC	
Tornado							
2016-07		Frontal Conductor	26OE	26CA			
		Frontal Pasajero	15OE	15CA			
2006-04		Frontal Conductor	20A	20CA	50EC		
		Frontal Pasajero	18A	18CA	45EC		
Tracker							
2008-05		Frontal		19CA	48EC	4747EC	
		Frontal Conductor	19A				
		Frontal Pasajero	19B				
2004-99		Frontal		19CA	48EC	4747EC	
		Frontal Conductor	19A				
		Frontal Pasajero	19B				
1998		Trasera			38EC		
		Frontal	17A	17CA	42EC		
		Trasera			38EC		
Trailblazer							
2007		Frontal		22CA	55EC	5555EC	
		Frontal Conductor	22A				
		Frontal Pasajero	22B				
2006-02		Trasera					H300
		Frontal		22CA	55EC	5555EC	
		Frontal Conductor	22A				
		Frontal Pasajero	22B				
		Trasera			40EC		
Traverse							
2020		Frontal Conductor	24A	24CA	60EC		
		Frontal Pasajero	20A	20CA	50EC		
2019-18		Frontal Conductor	24A	24CA	60EC		
		Frontal Pasajero	20A	20CA	50EC		
2017-10		Trasera					H251
		Frontal Conductor	24OE	24CA			
		Frontal Pasajero	21OE	21CA			
		Trasera			34EC		
Trax							
2020		Frontal Conductor	26OE	26CA			
		Frontal Pasajero	13OE	13CA			
2018-13		Frontal Conductor	26OE	26CA			
		Frontal Pasajero	13OE	13CA			
		Trasera					H251
Uplander							
2009		Frontal Conductor	24A	24CA	60EC		
		Frontal Pasajero	22A	22CA	55EC		
2008-05		Frontal Conductor	24A	24CA	60EC		
		Frontal Pasajero	22A	22CA	55EC		
		Trasera			40EC		
Vectra							
2008-03		Frontal Conductor	24A	24CA	60EC		
		Frontal Pasajero	19A	19CA	48EC		
Venture							
2004-97		Frontal	24A	24CA	60EC	6060EC	
		Trasera			40EC		
Volt							
2019-16		Frontal	26OE	26CA			
Zafira							
2006		Frontal Conductor	28AOE	28CA			
		Frontal Pasajero	22OE	22CA			



			Pluma Plana		Convencional		Traseras Especiales
			ICON	Clear Advantage	ECO	ECO Set	
Ubicación							
Chevrolet (cont'd.)							
Zafira (cont'd.)							
2005-02		Frontal Conductor	24A	24CA	60EC		
		Frontal Pasajero	22A	22CA	55EC		
Chrysler							
200							
2016-15		Frontal Conductor	26A	26CA	65EC		
		Frontal Pasajero	19A	19CA	48EC		
2014		Frontal Conductor	24A	24CA	60EC		
		Frontal Pasajero	22B	22CA	55EC		
2013-12		Frontal Conductor	24A	24CA	60EC		
	Convertible	Frontal Pasajero	22A	22CA	55EC		
	Sedan	Frontal Pasajero	22B	22CA	55EC		
300							
2019-15		Frontal Conductor	24A	24CA	60EC		
		Frontal Pasajero	21A	21CA	53EC		
2014-12		Frontal Conductor	24A	24CA	60EC		
		Frontal Pasajero	21B	21CA	53EC		
2010-05		Frontal		22CA	55EC	5555EC	
		Frontal Conductor	22A				
		Frontal Pasajero	22B				
300M							
2004-01		Frontal Conductor	24A	24CA	60EC		
		Frontal Pasajero	22B	22CA	55EC		
2000-98		Frontal Conductor	24A	24CA	60EC		
		Frontal Pasajero	22A	22CA	55EC		
Aspen							
2009-07		Frontal Conductor	26A	26CA	65EC		
		Frontal Pasajero	21A	21CA	53EC		
		Trasera					H355
Chrysler R/T							
1997		Frontal Conductor	24A	24CA	60EC		
		Frontal Pasajero	22A	22CA	55EC		
Cirrus							
2006-01	Coupe	Frontal		22CA	55EC	5555EC	
		Frontal Conductor	22A				
		Frontal Pasajero	22B				
2000-98	Sedan	Frontal		22CA	55EC	5555EC	
		Frontal Conductor	22A				
		Frontal Pasajero	22B				
1997-96		Frontal		22CA	55EC	5555EC	
		Frontal Conductor	22A				
		Frontal Pasajero	22B				
Concorde							
2002-01		Frontal Conductor	24A	24CA	60EC		
		Frontal Pasajero	22A	22CA	55EC		
1997-93		Frontal Conductor	24A	24CA	60EC		
		Frontal Pasajero	22A	22CA	55EC		
Cordoba							
1982-80		Frontal		18CA	45EC	4545EC	
Crossfire							
2007-04		Frontal Conductor	20A	20CA	50EC		
		Frontal Pasajero	22B	22CA	55EC		
Grand Voyager							
2002-01		Frontal		28CA	70EC		
		Frontal Conductor	28A				
		Frontal Pasajero	28B				
		Trasera			40EC		
2000-96		Frontal		28CA	70EC		
		Frontal Conductor	28A				
		Frontal Pasajero	28B				
		Trasera			45EC		
1995		Frontal	22A	22CA	55EC	5555EC	
		Trasera			45EC		
1994		Frontal Conductor	22A	22CA	55EC		
		Frontal Pasajero	18A	18CA	45EC		
		Trasera			45EC		
1993-91		Frontal	18A	18CA	45EC	4545EC	
		Trasera			45EC		
Imperial							
1991		Frontal		18CA	45EC	4545EC	

C

			Pluma Plana		Convencional		Traseras Especiales
			ICON	Clear Advantage	ECO	ECO Set	
Ubicación							
Chrysler (cont'd.)							
Intrepid							
1997-94		Frontal Conductor	24A	24CA	60EC		
		Frontal Pasajero	22A	22CA	55EC		
LeBaron							
1992-91		Frontal		18CA	45EC	4545EC	
1987	Coupe	Frontal		18CA	45EC	4545EC	
	Sedan	Frontal		16CA	40EC	4040EC	
	Wagon	Frontal		18CA	45EC	4545EC	
1986-85	Coupe, Sedan	Frontal		16CA	40EC	4040EC	
	Wagon	Frontal		18CA	45EC	4545EC	
1984	Coupe, Sedan	Frontal	16A	16CA	40EC	4040EC	
	Wagon	Frontal		18CA	45EC	4545EC	
1983		Frontal	16A	16CA	40EC	4040EC	
1982	Coupe, Sedan	Frontal	16A	16CA	40EC	4040EC	
	Wagon	Frontal		18CA	45EC	4545EC	
1981-79		Frontal		18CA	45EC	4545EC	
1978	Coupe, Sedan	Frontal		18CA	45EC	4545EC	
LHS							
1997-96		Frontal Conductor	24A	24CA	60EC		
		Frontal Pasajero	22A	22CA	55EC		
Neon							
1997-95		Frontal Conductor	21A	21CA	53EC		
		Frontal Pasajero	18A	18CA	45EC		
New Yorker							
1995-94		Frontal	24A	24CA	60EC	6060EC	
1993-89		Frontal		18CA	45EC	4545EC	
1988		Frontal		18CA	45EC	4545EC	
		Frontal Conductor	18A				
		Frontal Pasajero	18B				
1987-85		Frontal	16A	16CA	40EC	4040EC	
Pacifica							
2019-17		Frontal Conductor	26A	26CA	65EC		
		Frontal Pasajero	20A	20CA	50EC		
		Trasera					H352
2008-04		Frontal	22A	22CA	55EC	5555EC	
		Trasera			34EC		
Phantom							
1994-87		Frontal		18CA	45EC	4545EC	
PT Cruiser							
2008-01		Frontal Conductor	20A	20CA	50EC		
		Frontal Pasajero	21B	21CA	53EC		
		Trasera			40EC		
Shadow							
1994-89		Frontal		18CA	45EC	4545EC	
Spirit							
1995-92		Frontal		18CA	45EC	4545EC	
1991-90		Frontal Conductor		18CA	45EC		
		Frontal Pasajero		19CA	48EC		
Stratus							
1997-95		Frontal		22CA	55EC	5555EC	
		Frontal Conductor	22A				
		Frontal Pasajero	22B				
Town & Country							
2016-10		Frontal Conductor	26A	26CA	65EC		
		Frontal Pasajero	20A	20CA	50EC		
		Trasera			40EC		
2009-08		Frontal Conductor	26A	26CA	65EC		
		Frontal Pasajero	20A	20CA	50EC		
		Trasera					H402
2007-01		Frontal		28CA	70EC		
		Frontal Conductor	28A				
		Frontal Pasajero	28B				
		Trasera			40EC		
2000-96		Frontal		28CA	70EC		
		Frontal Conductor	28A				
		Frontal Pasajero	28B				
		Trasera			45EC		
1995		Frontal	22A	22CA	55EC	5555EC	
		Trasera			45EC		
1994		Frontal Conductor	22A	22CA	55EC		
		Frontal Pasajero	18A	18CA	45EC		
		Trasera			45EC		



		Ubicación	Pluma Plana		Convencional		Traseras Especiales
			ICON	Clear Advantage	ECO	ECO Set	
Chrysler (cont'd.)							
Valiant							
1983-82		Frontal	15A	15CA	38EC		
1980-75		Frontal	15A	15CA	38EC		
Volare							
1986-84		Frontal		18CA	45EC	4545EC	
Voyager							
2008		Frontal Conductor	26A	26CA	65EC		
		Frontal Pasajero	20A	20CA	50EC		
		Trasera			40EC		
2007-01		Frontal		28CA	70EC		
		Frontal Conductor	28A				
		Frontal Pasajero	28B				
2000-96		Trasera			40EC		
		Frontal		28CA	70EC		
		Frontal Conductor	28A				
1995		Frontal Pasajero	28B				
		Trasera			45EC		
		Frontal	22A	22CA	55EC	5555EC	
1994		Trasera			45EC		
		Frontal Conductor	22A	22CA	55EC		
		Frontal Pasajero	18A	18CA	45EC		
		Trasera			45EC		
Dodge							
Atos							
2012-01		Frontal Conductor	20A	20CA	50EC		
		Frontal Pasajero	16A	16CA	40EC		
Attitude							
2017-13		Frontal Conductor	26A	26CA	65EC		
		Frontal Pasajero	16A	16CA	40EC		
2012-06		Frontal Conductor	22A	22CA	55EC		
		Frontal Pasajero	16A	16CA	40EC		
Avenger							
2014-08		Frontal Conductor	24A	24CA	60EC		
		Frontal Pasajero	22B	22CA	55EC		
Caliber							
2012-07		Frontal Conductor	24A	24CA	60EC		
		Frontal Pasajero	17B	17CA	42EC		
Challenger							
2019-08		Frontal		22CA	55EC	5555EC	
		Frontal Conductor	22A				
		Frontal Pasajero	22B				
Charger							
2019-11		Frontal Conductor	24A	24CA	60EC		
		Frontal Pasajero	21A	21CA	53EC		
2010-06		Frontal		22CA	55EC	5555EC	
		Frontal Conductor	22A				
		Frontal Pasajero	22B				
D100 Panel							
1979		Frontal			45EC	4545EC	
1977-76		Frontal			45EC	4545EC	
Dakota							
2012		Frontal Conductor	21A	21CA	53EC		
		Frontal Pasajero	20B	20CA	50EC		
2011		Frontal				5353EC	
		Frontal Conductor	21A	21CA	53EC		
2010-05		Frontal Pasajero	22B	22CA	55EC		
		Frontal Conductor	21A	21CA	53EC		
1996		Frontal Pasajero	20B	20CA	50EC		
		Frontal		18CA	45EC	4545EC	
Dart							
2016-15		Frontal Conductor	26A	26CA	65EC		
		Frontal Pasajero	18A	18CA	45EC		
2014		Frontal Conductor	26A	26CA	65EC		
		Frontal Pasajero	18B	18CA	45EC		
1989-83		Frontal	16A	16CA	40EC	4040EC	
1982	Coupe	Frontal	16A	16CA	40EC	4040EC	
1977	Wagon	Frontal	16A	16CA	40EC	4040EC	
1976		Frontal	15A	15CA	38EC		
DM350							
1991		Frontal		18CA	45EC	4545EC	

**C
D**

		Ubicación	Pluma Plana		Convencional		Traseras Especiales
			ICON	Clear Advantage	ECO	ECO Set	
Dodge (cont'd.)							
Durango							
2019-12	Frontal Conductor	22A	22CA	55EC			
	Frontal Pasajero	21A	21CA	53EC			
	Trasera						H307
2009-04	Frontal Conductor	26A	26CA	65EC			
	Frontal Pasajero	21A	21CA	53EC			
	Trasera						H355
2003	Frontal	21A	21CA	53EC	5353EC		
	Trasera			40EC			
2002	Frontal		21CA	53EC	5353EC		
	Frontal Conductor	21A					
	Frontal Pasajero	21B					
2001	Trasera			40EC			
	Frontal Conductor	21A	21CA	53EC			
	Frontal Pasajero	20B	20CA	50EC			
2000-99	Trasera			40EC			
	Frontal		20CA	50EC	5050EC		
	Frontal Conductor	20A					
1998	Frontal Pasajero	20B					
	Trasera			40EC			
	Frontal		20CA	50EC	5050EC		
1998	Frontal Conductor	20A					
	Frontal Pasajero	20B					
	Trasera			40EC			
Grand Caravan							
2019-17	Frontal Conductor	26A	26CA	65EC			
	Frontal Pasajero	20A	20CA	50EC			
	Trasera			40EC			
H100							
2010	Frontal Conductor	24A	24CA	60EC			
	Frontal Pasajero	20A	20CA	50EC			
	Frontal	18A	18CA	45EC	4545EC		
H100 Van							
2013-10	Frontal	18A	18CA	45EC	4545EC		
i10							
2014-12	Frontal Conductor	22A	22CA	55EC			
	Frontal Pasajero	16A	16CA	40EC			
Intrepid							
2001-98	Frontal Conductor	24A	24CA	60EC			
	Frontal Pasajero	22A	22CA	55EC			
Journey							
2019	Frontal Conductor	24A	24CA	60EC			
	Frontal Pasajero	19A	19CA	48EC			
	Frontal	24A	24CA	60EC			
2018-15	Frontal Conductor	24A	24CA	60EC			
	Frontal Pasajero	19A	19CA	48EC			
	Trasera						H307
2014-09	Frontal Conductor	24A	24CA	60EC			
	Frontal Pasajero	19B	19CA	48EC			
	Trasera						H307
Magnum							
1988-82	Frontal	22A	22CA	55EC	5555EC		
Monaco							
1977-74	Frontal		18CA	45EC	4545EC		
Neon							
2017	Frontal Conductor	22A	22CA	55EC			
	Frontal Pasajero	19A	19CA	48EC			
2005-99	Frontal Conductor	22A	22CA	55EC			
	Frontal Pasajero	19A	19CA	48EC			
1998	Frontal Conductor	21A	21CA	53EC			
	Frontal Pasajero	18A	18CA	45EC			
Nitro							
2012	Frontal	19A	19CA	48EC	4747EC		
2011-09	Frontal		19CA	48EC	4747EC		
	Frontal Conductor	19A					
	Frontal Pasajero	19B					
	Trasera						H251
2008-07	Frontal		19CA	48EC	4747EC		
	Frontal Conductor	19A					
	Frontal Pasajero	19B					
	Trasera						H240
Ramcharger							
2001-99	Frontal		18CA	45EC	4545EC		
1996-95	Frontal		18CA	45EC	4545EC		

D

		Ubicación	Pluma Plana		Convencional		Traseras Especiales
			ICON	Clear Advantage	ECO	ECO Set	
Dodge (cont'd.)							
Ramcharger (cont'd.)							
1992-88		Frontal		18CA	45EC	4545EC	
1987-84		Frontal			45EC	4545EC	
Ram Pickup (Serie D, W)							
2010		Frontal		22CA	55EC	5555EC	
		Frontal Conductor	22A				
		Frontal Pasajero	22B				
2009		Frontal	24A	22CA	55EC	5555EC	
		Frontal	24A	24CA	60EC	6060EC	
		Frontal Conductor	22A				
		Frontal Pasajero	22B				
2008-03		Frontal	24A	24CA	60EC	6060EC	
2002		Frontal	24A	20CA	50EC	5050EC	
		Frontal	24A	24CA	60EC	6060EC	
		Frontal Conductor	20A				
		Frontal Pasajero	20B				
2001-94		Frontal		20CA	50EC	5050EC	
		Frontal Conductor	20A				
		Frontal Pasajero	20B				
1993-88		Frontal		18CA	45EC	4545EC	
1987-75		Frontal			45EC	4545EC	
Royal Monaco							
1977		Frontal		18CA	45EC	4545EC	
Stratus							
2006-98		Frontal		22CA	55EC	5555EC	
		Frontal Conductor	22A				
		Frontal Pasajero	22B				
Van, Ram Van, (Serie A, B)							
2003		Frontal	19A	19CA	48EC	4747EC	
2002-99		Frontal		19CA	48EC	4747EC	
		Frontal Conductor	19A				
		Frontal Pasajero	19B				
1998		Frontal	18A	18CA	45EC	4545EC	
		Frontal	20A	20CA	50EC	5050EC	
1997-95		Frontal	20A	18CA	45EC	4545EC	
		Frontal	20A	20CA	50EC	5050EC	
Verna							
2006-04		Frontal Conductor	20A	20CA	50EC		
		Frontal Pasajero	18A	18CA	45EC		
Viper							
2010-08		Frontal	16A	16CA	40EC	4040EC	
2000		Frontal	16A	16CA	40EC	4040EC	
1994-92		Frontal	16A	16CA	40EC	4040EC	
Vision							
2018-15		Frontal Conductor	22A	22CA	55EC		
		Frontal Pasajero	18A	18CA	45EC		
Ferrari							
360							
2004-01		Frontal Conductor	24A	24CA	60EC		
		Frontal Pasajero	20B	20CA	50EC		
2000		Frontal Conductor	24A	24CA	60EC		
		Frontal Pasajero	20A	20CA	50EC		
F355							
1999	Convertible	Frontal	20A	20CA	50EC	5050EC	
Fiat							
500							
2017-12		Frontal Conductor	24A	24CA	60EC		
		Frontal Pasajero	13A	13CA	34EC		
	Hatchback	Trasera					H309
2011-09		Frontal Conductor	24OE	24CA			
		Frontal Pasajero	13OE	13CA			
500L							
2019-15		Frontal Conductor	26OE	26CA			
		Frontal Pasajero	15OE	15CA			
		Trasera					H840
500X							
2017-16		Frontal Conductor	26OE	26CA			
		Frontal Pasajero	13OE	13CA			
		Trasera					H840

**D
F**



		Pluma Plana		Convencional		
Ubicación		ICON	Clear Advantage	ECO	ECO Set	Traseras Especiales
Fiat (cont'd.)						
Albea						
2011-09	Frontal Conductor	22A	22CA	55EC		
	Frontal Pasajero	18A	18CA	45EC		
Bravo						
2009	Frontal Conductor	22A	22CA	55EC		
	Frontal Pasajero	18A	18CA	45EC		
Ducato						
2019-11	Frontal Conductor	26OE	26CA			
	Frontal Pasajero	21OE	21CA			
2009-08	Frontal Conductor	26OE	26CA			
	Frontal Pasajero	21OE	21CA			
Idea						
2009-08	Frontal Conductor	22A	22CA	55EC		
	Frontal Pasajero	18A	18CA	45EC		
Linea						
2011	Frontal Conductor	26OE	26CA			
	Frontal Pasajero	15OE	15CA			
Mobi						
2020-17	Frontal Conductor	24A	24CA	60EC		
	Frontal Pasajero	16A	16CA	40EC		
Palio						
2017-13	Frontal Conductor	22A	22CA	55EC		
	Frontal Pasajero	18A	18CA	45EC		
	Trasera			38EC		
2009	Wagon Frontal Conductor	22A	22CA	55EC		
	Frontal Pasajero	18A	18CA	45EC		
	Trasera			38EC		
2008-05	Frontal Conductor	22A	22CA	55EC		
	Frontal Pasajero	18A	18CA	45EC		
	Trasera			38EC		
Panda						
2012-11	Frontal Conductor	22A	22CA	55EC		
	Frontal Pasajero	16A	16CA	40EC		
2009	Frontal Conductor	22A	22CA	55EC		
	Frontal Pasajero	16A	16CA	40EC		
2008	Frontal	22A	22CA	55EC	5555EC	
2007	Frontal Conductor	22A	22CA	55EC		
	Frontal Pasajero	16A	16CA	40EC		
Punto						
2013	Frontal Conductor	26OE	26CA			
	Frontal Pasajero	15OE	15CA			
2009-07	Frontal Conductor	22A	22CA	55EC		
	Frontal Pasajero	18A	18CA	45EC		
Stilo						
2007	Frontal Conductor	22OE	22CA			
	Frontal Pasajero	19OE	19CA			
Strada						
2014	Frontal Conductor	22A	22CA	55EC		
	Frontal Pasajero	18A	18CA	45EC		
2013	Pickup de tamaño estándar Frontal Conductor	22A	22CA	55EC		
	Frontal Pasajero	18A	18CA	45EC		
2012-07	Frontal Conductor	22A	22CA	55EC		
	Frontal Pasajero	18A	18CA	45EC		
Uno						
2017-13	Frontal Conductor	24A	24CA	60EC		
	Frontal Pasajero	16A	16CA	40EC		
Ford						
Aerostar						
1995	Frontal	22A	22CA	55EC	5555EC	
	Trasera			40EC		
1994-91	Frontal		22CA	55EC	5555EC	
	Trasera			40EC		
B-100						
1979-78	Frontal	15A	15CA	38EC		
B-200						
1986	Frontal		18CA	45EC	4545EC	
B-200 Panel						
1986	Frontal		18CA	45EC	4545EC	

F

		Ubicación	Pluma Plana		Convencional		Traseras Especiales
			ICON	Clear Advantage	ECO	ECO Set	
Ford (cont'd.)							
Club Wagon							
1998	Frontal			20CA	50EC	5050EC	
	Frontal Conductor	20A					
	Frontal Pasajero	20B					
1997-95	Frontal			22CA	55EC	5555EC	
	Frontal Conductor	22A					
	Frontal Pasajero	22B					
Contour							
2000-98	Frontal Conductor	22A	22CA	55EC			
	Frontal Pasajero	20B	20CA	50EC			
1996	Frontal Conductor	22A	22CA	55EC			
	Frontal Pasajero	20B	20CA	50EC			
Cougar							
1995-90	Frontal		22CA	55EC	5555EC		
1988-85	Frontal		18CA	45EC	4545EC		
Courier							
2012-01	Frontal Conductor	24A	24CA	60EC			
	Frontal Pasajero	19A	19CA	48EC			
Crown Victoria							
2011-05	Frontal		22CA	55EC	5555EC		
	Frontal Conductor	22A					
	Frontal Pasajero	22B					
2004-03	Frontal		22CA	55EC	5555EC		
2002-98	Frontal		22CA	55EC	5555EC		
	Frontal Conductor	22A					
Frontal Pasajero	22B						
Ecoline Van							
2008-05	Frontal		20CA	50EC	5050EC		
	Frontal Conductor	20A					
	Frontal Pasajero	20B					
2004	Frontal		20CA				
2003-98	Frontal		20CA	50EC	5050EC		
	Frontal Conductor	20A					
	Frontal Pasajero	20B					
1997-95	Frontal		22CA	55EC	5555EC		
	Frontal Conductor	22A					
	Frontal Pasajero	22B					
Econoline Van							
2014-10	Frontal		20CA	50EC	5050EC		
	Frontal Conductor	20A					
	Frontal Pasajero	20B					
Econoline Wagon							
2014-10	Frontal		20CA	50EC	5050EC		
	Frontal Conductor	20A					
	Frontal Pasajero	20B					
EcoSport							
2020	Frontal Conductor	26OE	26CA				
	Frontal Pasajero	24OE	24CA				
2019-17	Frontal Conductor	26OE	26CA				
	Frontal Pasajero	24OE	24CA				
2016-13	Trasera						A281H
	Frontal Conductor	26OE	26CA				
2012-08	Frontal Pasajero	15OE	16CA				
	Frontal Conductor	26OE	26CA				
2007-04	Frontal Pasajero	15OE	15CA				
	Frontal Conductor	24A	24CA	60EC			
Frontal Pasajero	18A	18CA	45EC				
Edge							
2020	Frontal		28CA				
	Frontal Conductor	28AOE					
	Frontal Pasajero	28BOE					
2019-15	Frontal		28CA				
	Frontal Conductor	28AOE					
	Frontal Pasajero	28BOE					
2014	Trasera						A380H
	Frontal Conductor	26A	26CA	65EC			
2013-07	Frontal Pasajero	20A	20CA	50EC			
	Trasera						H353
2013-07	Frontal Conductor	26A	26CA	65EC			
	Frontal Pasajero	20B	20CA	50EC			
	Trasera						H353



		Ubicación	Pluma Plana		Convencional		Traseras Especiales
			ICON	Clear Advantage	ECO	ECO Set	
Ford (cont'd.)							
Escape							
2019-13		Frontal		28CA			
		Frontal Conductor	28AOE				
		Frontal Pasajero	28BOE				
2012-08		Trasera, Remueva el adaptador					A281H
		Frontal	20OE	20CA			
2007-05		Trasera					H300
		Frontal Conductor	20A	20CA	50EC		
		Frontal Pasajero	18A	18CA	45EC		
2004-01		Trasera					H251
		Frontal	19A	19CA	48EC	4747EC	
		Trasera					H251
Escort							
2001		Frontal Conductor	20A	20CA	50EC		
		Frontal Pasajero	18B	18CA	45EC		
2000-98		Frontal Conductor	20A	20CA	50EC		
		Frontal Pasajero	18A	18CA	45EC		
1997-96		Frontal Conductor	20A	20CA	50EC		
		Frontal Pasajero	18A	18CA	45EC		
1995	Wagon	Trasera			34EC		
		Frontal Conductor	20A	20CA	50EC		
1994		Frontal Pasajero	18A	18CA	45EC		
	Hatchback	Trasera			34EC		
		Frontal Conductor	20A	20CA	50EC		
		Frontal Pasajero	18B	18CA	45EC		
		Trasera			34EC		
Excursion							
2005-01		Frontal	20A	20CA	50EC	5050EC	
		Trasera			40EC		
Expedition							
2019		Frontal	22A	22CA	55EC	5555EC	
		Trasera, Remueva el adaptador					A281H
2018		Frontal		22CA	55EC	5555EC	
		Frontal Conductor	22A				
2017		Frontal Pasajero	22B				
		Trasera, Remueva el adaptador					A281H
		Frontal		22CA	55EC	5555EC	
2016-09		Frontal Conductor	22A				
		Frontal Pasajero	22B				
		Trasera					A383H²⁰
2008		Frontal		22CA	55EC	5555EC	
		Frontal Conductor	22A				
2007-03		Frontal Pasajero	22B				
		Trasera			40EC		
		Frontal		20CA	50EC	5050EC	
2002-99		Frontal Conductor	20A				
		Frontal Pasajero	20B				
		Trasera			42EC		
1998-97		Frontal		20CA	50EC	5050EC	
		Trasera			40EC		
2005		Frontal		22CA	55EC	5555EC	
		Frontal Conductor	22A				
		Frontal Pasajero	22B				
		Trasera			40EC		
Explorer							
2019-18		Frontal Conductor	26OE	26CA			
		Frontal Pasajero	22OE	22CA			
		Trasera, Remueva el adaptador					A281H
2017-11		Frontal Conductor	26OE	26CA			
		Frontal Pasajero	22OE	22CA			
2010-06		Trasera					A281H
		Frontal	20A	20CA	50EC	5050EC	
2005		Trasera			34EC		
		Frontal	20A	20CA	50EC	5050EC	
		Trasera			40EC		

		Ubicación	Pluma Plana		Convencional		Traseras Especiales
			ICON	Clear Advantage	ECO	ECO Set	
Ford (cont'd.)							
Explorer (cont'd.)							
2004-02		Frontal	22A	22CA	55EC	5555EC	
		Trasera			40EC		
2001-98		Frontal	18A	18CA	45EC	4545EC	
		Trasera			38EC		
1997-91		Frontal	18A	18CA	45EC	4545EC	
		Trasera			34EC		
Explorer Sport							
2003-01		Frontal	18A	18CA	45EC	4545EC	
Explorer Sport Trac							
2010-07		Frontal	20A	20CA	50EC	5050EC	
Fairmont							
1983-78		Frontal		16CA	40EC	4040EC	
Fiesta							
2019-11		Frontal Conductor	24OE	24CA			
		Frontal Pasajero	15OE	15CA			
	Hatchback	Trasera					H840
2010-09	Hatchback	Frontal Conductor	22A	22CA	55EC		
		Frontal Pasajero	16A	16CA	40EC		
	Sedan	Frontal Conductor	26OE	26CA			
2008-05		Frontal Conductor	22A	22CA	55EC		
		Frontal Pasajero	16A	16CA	40EC		
2004		Frontal	19A	19CA	48EC	4747EC	
2003	Hatchback	Frontal	19A	19CA	48EC	4747EC	
	Sedan	Frontal Conductor	22A	22CA	55EC		
2001	Hatchback	Frontal Pasajero	16A	16CA	40EC		
		Frontal	19A	19CA	48EC	4747EC	
2000-98		Frontal	19A	19CA	48EC	4747EC	
Fiesta Ikon							
2013		Frontal Conductor	26OE	26CA			
		Frontal Pasajero	15OE	15CA			
2012	Hatchback	Frontal Conductor	28OE	28CA			
		Frontal Pasajero	15OE	15CA			
2004-02		Frontal Conductor	22A	22CA	55EC		
		Frontal Pasajero	16A	16CA	40EC		
Figo							
2017		Frontal Conductor	24OE	24CA			
		Frontal Pasajero	15OE	15CA			
2016		Frontal Conductor	22A	22CA	55EC		
		Frontal Pasajero	16A	16CA	40EC		
Five Hundred							
2007-05		Frontal Conductor	24OE	24CA			
		Frontal Pasajero	20OE	20CA			
Focus							
2018-12		Frontal		28CA			
		Frontal Conductor	28AOE				
		Frontal Pasajero	28BOE				
2011-10	Hatchback	Trasera					H304
	Sedan	Frontal Conductor	22A	22CA	55EC		
2009-05		Frontal Pasajero	19A	19CA	48EC		
		Frontal Conductor	22A	22CA	55EC		
2004-00		Frontal Pasajero	19A	19CA	48EC		
		Frontal Conductor	22A	22CA	55EC		
	Hatchback	Frontal Pasajero	19A	19CA	48EC		
		Trasera			38EC		
Freestar							
2007-04		Frontal Conductor	24A	24CA	60EC		
		Frontal Pasajero	20B	20CA	50EC		
		Trasera			40EC		
F Series Pickup							
2019		Frontal		22CA	55EC	5555EC	
		Frontal Conductor	22A				
		Frontal Pasajero	22B				
	Pickup versión crew cab	Frontal		22CA	55EC	5555EC	
		Frontal Conductor	22A				
	Pickup con cabina extendida	Frontal Pasajero	22B				
		Frontal		22CA	55EC	5555EC	
		Frontal Conductor	22A				
	Frontal Pasajero	22B					



			Pluma Plana		Convencional		Traseras Especiales
			ICON	Clear Advantage	ECO	ECO Set	
Ford (cont'd.)							
F Series Pickup (cont'd.)							
2018-09		Frontal		22CA	55EC	5555EC	
		Frontal Conductor	22A				
		Frontal Pasajero	22B				
2008		Frontal		20CA	50EC	5050EC	
		Frontal		22CA	55EC	5555EC	
		Frontal Conductor	20A				
		Frontal Conductor	22A				
		Frontal Pasajero	20B				
		Frontal Pasajero	22B				
2007-02		Frontal		20CA	50EC	5050EC	
		Frontal Conductor	20A				
		Frontal Pasajero	20B				
2001-99		Frontal		18CA	45EC	4545EC	
		Frontal		20CA	50EC	5050EC	
		Frontal Conductor	18A				
		Frontal Conductor	20A				
		Frontal Pasajero	18B				
		Frontal Pasajero	20B				
1998		Frontal		22CA	55EC	5555EC	
		Frontal Conductor	22A				
		Frontal Pasajero	22B				
1997		Frontal		18CA	45EC	4545EC	
		Frontal		22CA	55EC	5555EC	
		Frontal Conductor	18A				
		Frontal Conductor	22A				
		Frontal Pasajero	18B				
		Frontal Pasajero	22B				
1996-94		Frontal		18CA	45EC	4545EC	
		Frontal Conductor	18A				
		Frontal Pasajero	18B				
1993-80		Frontal		18CA	45EC	4545EC	
1979-75		Frontal	15A	15CA	38EC		
Fusion							
2020-13		Frontal Conductor, Para vehículos sin sensor de lluvia		28CA			
		Frontal Pasajero, Para vehículos sin sensor de lluvia		26CA			
2012-06		Frontal Conductor	24A	24CA	60EC		
		Frontal Pasajero	19B	19CA	48EC		
Galaxie 500							
1974	Sedan	Frontal	18A	18CA	45EC	4545EC	
Ghia							
1994-91		Frontal		20CA	50EC	5050EC	
Grand Marquis							
2004-03		Frontal		22CA	55EC	5555EC	
2002-94		Frontal	22A	22CA	55EC	5555EC	
1993-92		Frontal		22CA	55EC	5555EC	
Ikon							
2007-03		Frontal Conductor	22A	22CA	55EC		
		Frontal Pasajero	16A	16CA	40EC		
Ka							
2008-01		Frontal				4742EC	
		Frontal Conductor	19A	19CA	48EC		
		Frontal Pasajero	17A	17CA	42EC		
Lobo							
2019	Pickup versión crew cab	Frontal		22CA	55EC	5555EC	
		Frontal Conductor	22A				
		Frontal Pasajero	22B				
2018-09		Frontal		22CA	55EC	5555EC	
		Frontal Conductor	22A				
		Frontal Pasajero	22B				
2008-99		Frontal		20CA	50EC	5050EC	
		Frontal Conductor	20A				
		Frontal Pasajero	20B				
1998		Frontal		22CA	55EC	5555EC	
		Frontal Conductor	22A				
		Frontal Pasajero	22B				

F

			Pluma Plana		Convencional		Traseras Especiales
			ICON	Clear Advantage	ECO	ECO Set	
Ubicación							
Ford (cont'd.)							
Lobo (cont'd.)							
1997		Frontal		18CA	45EC	4545EC	
		Frontal Conductor	18A				
		Frontal Pasajero	18B				
LTD							
1980	Wagon	Frontal		18CA	45EC	4545EC	
		Trasera			40EC		
1979-77	Hardtop	Frontal		16CA	40EC	4040EC	
	Wagon	Frontal		18CA	45EC	4545EC	
		Trasera			40EC		
1976-75		Frontal		18CA	45EC	4545EC	
	Wagon	Trasera			40EC		
Maverick							
1977-74		Frontal	16A	16CA	40EC	4040EC	
Mustang							
2020-19	Coupe	Frontal Conductor	22OE	22CA			
		Frontal Pasajero	20OE	20CA			
2018-10		Frontal Conductor	22OE	22CA			
		Frontal Pasajero	20OE	20CA			
2009-07		Frontal Conductor, No aplica para Shelby Serie 500	22A	22CA	55EC		
		Frontal Pasajero, No aplica para Shelby Serie 500	20A	20CA	50EC		
2006-05		Frontal Conductor	22A	22CA	55EC		
		Frontal Pasajero	20A	20CA	50EC		
2004-01		Frontal		20CA	50EC	5050EC	
		Frontal Conductor	20A				
		Frontal Pasajero	20B				
2000-94		Frontal	20A	20CA	50EC	5050EC	
1984-83		Frontal		16CA	40EC	4040EC	
1982-79	Hatchback	Frontal		16CA	40EC	4040EC	
		Trasera			45EC		
Mustang II							
1978-74		Frontal		18CA	45EC	4545EC	
Mystique							
2000-95		Frontal Conductor	22A	22CA	55EC		
		Frontal Pasajero	20A	20CA	50EC		
P-350							
1997-96		Frontal		18CA	45EC	4545EC	
1993		Frontal		18CA	45EC	4545EC	
1975		Frontal		18CA	45EC	4545EC	
P-400							
1975		Frontal		18CA	45EC	4545EC	
Ranger							
2017-16		Frontal Conductor	24OE	24CA			
		Frontal Pasajero	15OE	15CA			
2015-12		Frontal Conductor	24A	24CA	60EC		
		Frontal Pasajero	16A	16CA	40EC		
2011-02		Frontal		18CA	45EC	4545EC	
		Frontal Conductor	18A				
		Frontal Pasajero	18B				
Sable							
2001-97		Frontal Conductor	24A	24CA	60EC		
		Frontal Pasajero	20B	20CA	50EC		
1995		Frontal		20CA	50EC	5050EC	
		Frontal Conductor	20A				
		Frontal Pasajero	20B				
Taurus							
1991-88		Frontal		20CA	50EC	5050EC	
Thunderbird							
2003		Frontal Conductor	24A	24CA	60EC		
		Frontal Pasajero	22B	22CA	55EC		
1996-90		Frontal		22CA	55EC	5555EC	
1989		Frontal Conductor	24A	24CA	60EC		
		Frontal Pasajero	20B	20CA	50EC		
1988-87		Frontal		18CA	45EC	4545EC	
Transit							
2019-17		Frontal Conductor	28AOE ²⁰	28CA ²⁰			
		Frontal Pasajero	20OE ²⁰	20CA ²⁰			





		Ubicación	Pluma Plana		Convencional		Traseras Especiales
			ICON	Clear Advantage	ECO	ECO Set	
Ford (cont'd.)							
Transit (cont'd.)							
2016-14	Frontal Conductor		28AOE				
	Frontal Pasajero		20OE				
2012-07	Frontal Conductor		26A	26CA	65EC		
	Frontal Pasajero		22A	22CA	55EC		
Transit Custom							
2019-17	Frontal Conductor		28AOE ²⁰	28CA ²⁰			
	Frontal Pasajero		20OE ²⁰	20CA ²⁰			
Windstar							
2003-96	Frontal Conductor		24A	24CA	60EC		
	Frontal Pasajero		20B	20CA	50EC		
	Trasera				40EC		
1995	Frontal Conductor		24A	24CA	60EC		
	Frontal Pasajero		20B	20CA	50EC		
	Trasera				34EC		
Foton							
Forland							
2007	Frontal		16A	16CA	40EC	4040EC	
Ollin							
2007	Frontal		16A	16CA	40EC	4040EC	
Geo							
Tracker							
1994-93	Frontal		17A	17CA	42EC		
GMC							
Acadia							
2019-17	Frontal Conductor		24A	24CA	60EC		
	Frontal Pasajero		20A	20CA	50EC		
2016-13	Frontal Conductor		24OE	24CA			
	Frontal Pasajero		21OE	21CA			
	Trasera						H305
2012-07	Frontal Conductor		24OE	24CA			
	Frontal Pasajero		21OE	21CA			
Canyon							
2012-07	Frontal Conductor		22A	22CA	55EC		
	Frontal Pasajero		19B	19CA	48EC		
Sierra							
2018-08	Frontal		22OE	22CA			
2007	Frontal			22CA	55EC	5555EC	
	Frontal Conductor		22A				
	Frontal Pasajero		22B				
Terrain							
2019-18	Frontal Conductor		24A	24CA	60EC		
	Frontal Pasajero		18A	18CA	45EC		
2017-11	Frontal Conductor		24OE	24CA			
	Frontal Pasajero		17OE	17CA			
	Trasera				34EC		
Yukon							
2020	Frontal		22A	22CA	55EC	5555EC	
2019-15	Frontal		22A	22CA	55EC	5555EC	
	Trasera						H772
2014-09	Frontal			22CA	55EC	5555EC	
	Frontal Conductor		22A				
	Frontal Pasajero		22B				
2008	Trasera						H300
	Frontal, Última producción			22CA	55EC	5555EC	
	Frontal, Producción temprana		22OE	22CA			
2007	Frontal Conductor, Última producción		22A				
	Frontal Pasajero, Última producción		22B				
	Trasera						H300
	Frontal, Producción temprana			22CA	55EC	5555EC	
	Frontal, Última producción		22OE	22CA			
2007	Frontal Conductor, Producción temprana		22A				
	Frontal Pasajero, Producción temprana		22B				
	Trasera, Última producción						H300

		Ubicación	Pluma Plana		Convencional		Traseras Especiales
			ICON	Clear Advantage	ECO	ECO Set	
GMC (cont'd.)							
Yukon (cont'd.)							
2007		Trasera, Producción temprana			40EC		
Honda							
Accord							
2020-18		Frontal Conductor	26A	26CA	65EC		
		Frontal Pasajero	16A	16CA	40EC		
2012-08		Frontal Conductor	26A	26CA	65EC		
	Coupe	Frontal Pasajero	19A	19CA	48EC		
	Sedan	Frontal Pasajero	19B	19CA	48EC		
2007-03		Frontal Conductor			65EC		
		Frontal Pasajero	18B	18CA	45EC		
2002-98		Frontal Conductor	24A	24CA	60EC		
		Frontal Pasajero	19B	19CA	48EC		
1997-96		Frontal Conductor	24A	24CA	60EC		
		Frontal Pasajero	20A	20CA	50EC		
Accord Crosstour							
2011-10		Frontal Conductor	26A	26CA	65EC		
		Frontal Pasajero	19B	19CA	48EC		
		Trasera	21A	21CA			
City							
2017-10		Frontal Conductor	24OE	24CA			
		Frontal Pasajero	13OE	13CA			
Civic							
2018	Coupe	Frontal Conductor	26A	26CA	65EC		
		Frontal Pasajero	18B	18CA	45EC		
2017-16		Frontal Conductor	26A	26CA	65EC		
		Frontal Pasajero	18B	18CA	45EC		
2015-12	Coupe	Frontal Conductor	28A	28CA	70EC		
		Frontal Pasajero	24A	24CA	60EC		
	Sedan	Frontal Conductor	26A	26CA	65EC		
		Frontal Pasajero	22B	22CA	55EC		
2011-10	Coupe	Frontal Conductor	28AOE	28CA			
		Frontal Pasajero	24OE	24CA			
	Sedan	Frontal Conductor	26A	26CA	65EC		
		Frontal Pasajero		22CA	55EC		
2009-08	Coupe	Frontal Conductor	28AOE	28CA			
		Frontal Pasajero	24OE	24CA			
	Sedan	Frontal Conductor		26CA	65EC		
		Frontal Pasajero		22CA	55EC		
2007-06	Coupe	Frontal Conductor	28AOE	28CA			
		Frontal Pasajero	24OE	24CA			
2005-01		Frontal				5347EC	
		Frontal Conductor	21A	21CA	53EC		
		Frontal Pasajero	19B	19CA	48EC		
2000-97		Frontal Conductor	20A	20CA	50EC		
		Frontal Pasajero	18B	18CA	45EC		
Crosstour							
2014-12		Frontal Conductor	26A	26CA	65EC		
		Frontal Pasajero	19B	19CA	48EC		
		Trasera	21A	21CA			
CR-V							
2019-17		Frontal Conductor	26A	26CA	65EC		
		Frontal Pasajero	17A	17CA	42EC		
		Trasera					H306
2016-11		Frontal Conductor	26A	26CA	65EC		
		Frontal Pasajero	16A	16CA	38EC		
		Trasera			34EC		
2010-07		Frontal Conductor	26A	26CA	65EC		
		Frontal Pasajero	16A	16CA	40EC		
		Trasera					H354
2006-02		Frontal Conductor	21A	21CA	53EC		
		Frontal Pasajero	20B	20CA	50EC		
CR-Z							
2015-13		Frontal Conductor	26A	26CA	65EC		
		Frontal Pasajero	21B	21CA	53EC		
Fit							
2019-15		Frontal Conductor	28A	28CA	70EC		
		Frontal Pasajero	13A	13CA	34EC		
		Trasera					H354

**G
H**

				Pluma Plana		Convencional			
		Ubicación		ICON	Clear Advantage	ECO	ECO Set	Traseras Especiales	
Honda (cont'd.)									
Fit (cont'd.)									
2008-07		Frontal Conductor	24A	24CA	60EC				
		Frontal Pasajero	16A	16CA	40EC				
		Trasera							H354
HR-V									
2020		Frontal Conductor	26A	26CA	65EC				
		Frontal Pasajero	18A	18CA	45EC				
2019-16		Frontal Conductor	26A	26CA	65EC				
		Frontal Pasajero	18A	18CA	45EC				
		Trasera							H250
Insight									
2020-19		Frontal Conductor	26A	26CA	65EC				
		Frontal Pasajero	18A	18CA	45EC				
Odyssey									
2019-05		Frontal Conductor	26A	26CA	65EC				
		Frontal Pasajero	22B	22CA	55EC				
		Trasera							H410
2004-00		Frontal Conductor	24A	24CA	60EC				
		Frontal Pasajero	21B	21CA	53EC				
		Trasera			42EC				
Pilot									
2020		Frontal Conductor	26A	26CA	65EC				
		Frontal Pasajero	22A	22CA	55EC				
2019-16		Frontal Conductor	26A	26CA	65EC				
		Frontal Pasajero	22A	22CA	55EC				
		Trasera							H354
2015-09		Frontal Conductor	22A	22CA	55EC				
		Frontal Pasajero	21B	21CA	53EC				
2008-03		Frontal Conductor	24A	24CA	60EC				
		Frontal Pasajero	21B	21CA	53EC				
		Trasera							H354
Ridgeline									
2014-09		Frontal		22CA	55EC		5555EC		
		Frontal Conductor	22A						
		Frontal Pasajero	22B						
2008-07		Frontal Conductor	24A	24CA	60EC				
		Frontal Pasajero	22B	22CA	55EC				
Hummer									
H2									
2009	Pickup versión crew cab	Frontal		17CA	42EC				
		Frontal Conductor	17A						
		Frontal Pasajero	17B						
2008	SUV	Frontal		17CA	42EC				
		Frontal Conductor	17A						
		Frontal Pasajero	17B						
2006-05	Pickup versión crew cab	Frontal		17CA	42EC				
		Frontal Conductor	17A						
H3T									
2010		Frontal Conductor	17A	17CA	42EC				
		Frontal Pasajero	16A	16CA	40EC				
Hyundai									
Accent									
2020-18	Sedan	Frontal Conductor	26A	26CA	65EC				
		Frontal Pasajero	16A	16CA	40EC				
Creta									
2017		Frontal Conductor	26A	26CA	65EC				
		Frontal Pasajero	16A	16CA	40EC				
Elantra									
2020-17		Frontal Conductor	26A	26CA	65EC				
		Frontal Pasajero	16A	16CA	40EC				
2016-15		Frontal Conductor	28A	28CA	70EC				
		Frontal Pasajero	13A	13CA	34EC				
Grand i10									
2019-18		Frontal Conductor	22A	22CA	55EC				
		Frontal Pasajero	16A	16CA	40EC				
2015		Frontal Conductor	22A	22CA	55EC				
		Frontal Pasajero	16A	16CA	40EC				
Ioniq									
2018		Frontal Conductor	26A	26CA	65EC				
		Frontal Pasajero	18A	18CA	45EC				

H

		Ubicación	Pluma Plana		Convencional		Traseras Especiales
			ICON	Clear Advantage	ECO	ECO Set	
Hyundai (cont'd.)							
ix35							
2015	Frontal Conductor		24A	24CA	60EC		
	Frontal Pasajero		16A	16CA	40EC		
Santa Fe							
2019	Frontal Conductor		26A	26CA	65EC		
	Frontal Pasajero		16A	16CA	40EC		
	Trasera						H326
2018	Frontal Conductor		26A	26CA	65EC		
	Frontal Pasajero		13A	13CA	34EC		
	Trasera						H326
Santa Fe Sport							
2018-17	Frontal Conductor		26A	26CA	65EC		
	Frontal Pasajero		13A	13CA	34EC		
	Trasera						H326
Sonata							
2018-15	Frontal Conductor		26A	26CA	65EC		
	Frontal Pasajero		18B	18CA	45EC		
Tucson							
2017-16	Frontal Conductor		26A	26CA	65EC		
	Frontal Pasajero		16A	16CA	40EC		
	Trasera						H352
Infiniti							
FX35							
2012	Frontal Conductor		24A	24CA	60EC		
	Frontal Pasajero		19B	19CA	48EC		
	Trasera						H354
FX37							
2013	Frontal Conductor		24A	24CA	60EC		
	Frontal Pasajero		19B	19CA	48EC		
	Trasera						H354
FX50							
2013-12	Frontal Conductor		24A	24CA	60EC		
	Frontal Pasajero		19B	19CA	48EC		
	Trasera						H354
G37							
2013-12	Frontal Conductor		26A	26CA	65EC		
	Coupe Frontal Pasajero		17B	17CA	42EC		
	Sedan Frontal Pasajero		16A	16CA	40EC		
I30							
2001	Frontal Conductor		26A	26CA	65EC		
	Frontal Pasajero		17B	17CA	42EC		
2000	Frontal Conductor		26A	26CA	65EC		
	Frontal Pasajero		17A	17CA	42EC		
1999-98	Frontal Conductor		22A	22CA	55EC		
	Frontal Pasajero		21A	21CA	53EC		
I35							
2003-02	Frontal Conductor		26A	26CA	65EC		
	Frontal Pasajero		17B	17CA	42EC		
JX35							
2013	Frontal Conductor		26A	26CA	65EC		
	Frontal Pasajero		17A	17CA	42EC		
M37							
2013-12	Frontal Conductor		26A	26CA	65EC		
	Frontal Pasajero		19B	19CA	48EC		
M56							
2013-12	Frontal Conductor		26A	26CA	65EC		
	Frontal Pasajero		19B	19CA	48EC		
Q45							
2006-02	Frontal Conductor		26A	26CA	65EC		
	Frontal Pasajero		18B	18CA	45EC		
2001	Frontal Conductor		22A	22CA	55EC		
	Frontal Pasajero		20B	20CA	50EC		
2000-97	Frontal Conductor		22A	22CA	55EC		
	Frontal Pasajero		20A	20CA	50EC		
1995-94	Frontal		21A	21CA	53EC	5353EC	
Q50							
2020-15	Frontal Conductor		26A	26CA	65EC		
	Frontal Pasajero		17B	17CA	42EC		

**H
I**

		Ubicación	Pluma Plana		Convencional		Traseras Especiales
			ICON	Clear Advantage	ECO	ECO Set	
Infiniti (cont'd.)							
Q60							
2016-14	Frontal Conductor	26A	26CA	65EC			
	Frontal Pasajero	17B	17CA	42EC			
Q70							
2019-16	Frontal Conductor	26A	26CA	65EC			
	Frontal Pasajero	19B	19CA	48EC			
2014	Frontal Conductor	26A	26CA	65EC			
	Frontal Pasajero	19B	19CA	48EC			
QX30							
2018-17	Frontal Conductor	24OE	24CA				
	Frontal Pasajero	19OE	19CA				
	Trasera						A275H
QX50							
2019	Frontal Conductor	26A	26CA	65EC			
	Frontal Pasajero	18A	18CA	45EC			
	Trasera						H306
QX56							
2013-12	Frontal Conductor	24A	24CA	60EC			
	Frontal Pasajero	19B	19CA	48EC			
	Trasera						H250
QX60							
2019-14	Frontal Conductor	26A	26CA	65EC			
	Frontal Pasajero	17A	17CA	42EC			
	Trasera						H301
QX70							
2018-14	Frontal Conductor	24A	24CA	60EC			
	Frontal Pasajero	19B	19CA	48EC			
	Trasera						H354
QX80							
2019-14	Frontal Conductor	24A	24CA	60EC			
	Frontal Pasajero	19B	19CA	48EC			
	Trasera						H250
Jaguar							
E-Pace							
2019-18	Trasera						A310H
F-Pace							
2019-17	Frontal Conductor	26OE	26CA				
	Frontal Pasajero	19OE	19CA				
	Trasera						A300H
S-Type							
2008-02	Frontal Conductor, Solo vehículos de de pasajeros sin water jet en la pluma	24A	24CA	60EC			
	Frontal Pasajero, Solo vehículos de de pasajeros sin water jet en la pluma	18B	18CA	45EC			
2001	Frontal		22CA	55EC	5555EC		
	Frontal Conductor	22A					
Frontal Pasajero	22B						
Super V8							
2009	Frontal Conductor	24A	24CA	60EC			
	Frontal Pasajero	19B	19CA	48EC			
Vanden Plas							
2005-04	Frontal Conductor	24A	24CA	60EC			
	Frontal Pasajero	19B	19CA	48EC			
2002	Frontal	21A	21CA	53EC	5353EC		
2001	Frontal		21CA	53EC	5353EC		
	Frontal Conductor	21A					
Frontal Pasajero	21B						
2000	Frontal	21A	21CA	53EC	5353EC		
1999-98	Frontal		21CA	53EC	5353EC		
	Frontal Conductor	21A					
Frontal Pasajero	21B						
XE							
2019-16	Frontal Conductor	28AOE	28CA				
	Frontal Pasajero	17OE	17CA				
XF							
2019-16	Frontal Conductor	28AOE	28CA				
	Frontal Pasajero	17OE	17CA				



		Ubicación	Pluma Plana		Convencional		Traseras Especiales
			ICON	Clear Advantage	ECO	ECO Set	
Jaguar (cont'd.)							
XF (cont'd.)							
2015-10	Frontal Conductor		22OE	22CA			
	Frontal Pasajero		19OE	19CA			
XFR							
2015-10	Frontal Conductor		22OE	22CA			
	Frontal Pasajero		19OE	19CA			
XJ							
2015-11	Frontal Conductor		22OE	22CA			
	Frontal Pasajero		19OE	19CA			
XJ8							
2003-01	Frontal			21CA	53EC	5353EC	
	Frontal Conductor		21A				
	Frontal Pasajero		21B				
2000-98	Frontal		21A	21CA	53EC	5353EC	
XJR							
2009-04	Frontal Conductor		24A	24CA	60EC		
	Frontal Pasajero		19B	19CA	48EC		
2003-01	Frontal			21CA	53EC	5353EC	
	Frontal Conductor		21A				
	Frontal Pasajero		21B				
2000-99	Frontal		21A	21CA	53EC	5353EC	
XK							
2010	Frontal Conductor		22A	22CA	55EC		
	Frontal Pasajero		21B	21CA	53EC		
2007	Frontal Conductor		22A	22CA	55EC		
	Frontal Pasajero		21B	21CA	53EC		
XK8							
2004-01	Frontal			21CA	53EC	5353EC	
	Frontal Conductor		21A				
	Frontal Pasajero		21B				
2000	Frontal		21A	21CA	53EC	5353EC	
1998	Frontal		21A	21CA	53EC	5353EC	
XKR							
2014-08	Frontal Conductor		22A	22CA	55EC		
	Frontal Pasajero		21B	21CA	53EC		
2006-03	Frontal			21CA	53EC	5353EC	
	Frontal Conductor		21A				
	Frontal Pasajero		21B				
2002-01	Frontal			21CA	53EC	5353EC	
	Frontal Conductor		21A				
	Convertible	Frontal Pasajero		21A			
2000	Coupe	Frontal Pasajero		21B			
	Frontal		21A	21CA	53EC	5353EC	
XKR-S							
2014	Frontal Conductor		22A	22CA	55EC		
	Frontal Pasajero		21B	21CA	53EC		
X-Type							
2008-02	Frontal Conductor		22A	22CA	55EC		
	Frontal Pasajero		19B	19CA	48EC		
2001	Frontal Conductor		22A	22CA	55EC		
	Frontal Pasajero		19A	19CA	48EC		
Jeep							
Cherokee							
2019-14	Frontal Conductor		26A	26CA	65EC		
	Frontal Pasajero		18A	18CA	45EC		
	Trasera						H352
2001-98	Frontal			18CA	45EC	4545EC	
	Frontal Conductor		18A				
	Frontal Pasajero		18B				
1994-93	Trasera				34EC		
	Frontal			18CA	45EC	4545EC	
	Trasera				34EC		
Commander							
2010-06	Frontal		18A	18CA	45EC	4545EC	
	Trasera						H355
Compass							
2019-18	Frontal Conductor		24A	24CA	60EC		
	Frontal Pasajero		18A	18CA	45EC		
	Trasera						H252

J

		Ubicación	Pluma Plana		Convencional		Traseras Especiales
			ICON	Clear Advantage	ECO	ECO Set	
Jeep (cont'd.)							
Compass (cont'd.)							
2017-14	Frontal Conductor		22A	22CA	55EC		
	Frontal Pasajero		20A	20CA	50EC		
	Trasera						H251
2013-12	Frontal Conductor		22A	22CA	55EC		
	Frontal Pasajero		20B	20CA	50EC		
	Trasera						H251
2010-07	Frontal Conductor		22A	22CA	55EC		
	Frontal Pasajero		20B	20CA	50EC		
	Trasera						H251
Grand Cherokee							
2019-14	Frontal Conductor		22A	22CA	55EC		
	Frontal Pasajero		21A	21CA	53EC		
	Trasera						H281
2013-11	Frontal Conductor		22A	22CA	55EC		
	Frontal Pasajero		21A	21CA	53EC		
	Trasera						H307
2010-05	Frontal			21CA	53EC	5353EC	
	Frontal Conductor		21A				
	Frontal Pasajero		21B				
2004-99	Trasera						H355
	Frontal			21CA	53EC	5353EC	
	Frontal Conductor		21A				
1998-93	Frontal Pasajero		21B				
	Trasera						
	Frontal			20CA	50EC	5050EC	
1998-93	Frontal Conductor		20A				
	Frontal Pasajero		20B				
	Trasera						
Grand Wagoneer							
1984	Frontal		16A	16CA	40EC	4040EC	
	Trasera				34EC		
J Series							
1980	Frontal			16CA	40EC	4040EC	
Liberty							
2012-02	Frontal		19A	19CA	48EC	4747EC	
Patriot							
2017-14	Frontal		21A	21CA	53EC	5353EC	
	Trasera						H251
2013-07	Frontal			21CA	53EC	5353EC	
	Frontal Conductor		21A				
	Frontal Pasajero		21B				
2013-07	Trasera						H251
	Trasera						
Renegade							
2019-17	Frontal Conductor		22OE	22CA			
	Frontal Pasajero		20OE	20CA			
	Trasera						H240
Wagoneer							
1987-85	Frontal			18CA	45EC	4545EC	
	Trasera				34EC		
1980	Frontal			16CA	40EC	4040EC	
	Trasera				34EC		
Wrangler							
2019	Frontal		16A	16CA	40EC	4040EC	
	Trasera						H306
2017-07	Frontal		15A	15CA	38EC		
	Trasera, Para vehículos con capota dura						H300
2006-05	Frontal		13A	13CA	34EC		
	Trasera, Para vehículos con capota dura				42EC		
2004-97	Frontal		13A	13CA	34EC		
	Trasera, Para vehículos con capota dura				45EC		
1995-93	Trasera, Para vehículos con capota dura				40EC		
	Trasera, Para vehículos con capota dura						
Wrangler JK							
2018	Frontal		16A	16CA	40EC	4040EC	
	Trasera, Para vehículos con capota dura						H300



			Pluma Plana		Convencional		Traseras Especiales
			ICON	Clear Advantage	ECO	ECO Set	
Ubicación							
Kia							
Forte							
2019	Sedan	Frontal Conductor	26A	26CA	65EC		
		Frontal Pasajero	18A	18CA	45EC		
2018-16		Frontal Conductor	28A	28CA	70EC		
		Frontal Pasajero	13A	13CA	34EC		
Niro							
2019-17		Frontal Conductor	26A	26CA	65EC		
		Frontal Pasajero	16A	16CA	40EC		
		Trasera					A300H
Optima							
2020-16		Frontal Conductor	26A	26CA	65EC		
		Frontal Pasajero	18A	18CA	45EC		
Rio							
2019	Hatchback	Frontal Conductor	26A	26CA	65EC		
		Frontal Pasajero	16A	16CA	40EC		
		Trasera					H253
2017-16		Frontal Conductor	26A	26CA	65EC		
		Frontal Pasajero	16A	16CA	40EC		
	Hatchback	Trasera					H281
Sorento							
2019-16		Frontal Conductor	26A	26CA	65EC		
		Frontal Pasajero	16A	16CA	40EC		
		Trasera					H312
Soul							
2020		Frontal Conductor	24A	24CA	60EC		
		Frontal Pasajero	20A	20CA	50EC		
2019-16		Frontal Conductor	24A	24CA	60EC		
		Frontal Pasajero	20A	20CA	50EC		
		Trasera					H281
Sportage							
2020		Frontal Conductor	26A	26CA	65EC		
		Frontal Pasajero	16A	16CA	40EC		
2019-17		Frontal Conductor	26A	26CA	65EC		
		Frontal Pasajero	16A	16CA	40EC		
		Trasera					H275
2016		Frontal Conductor	24A	24CA	60EC		
		Frontal Pasajero	18A	18CA	45EC		
		Trasera					H312
Stinger							
2020-18		Frontal Conductor	26A	26CA	65EC		
		Frontal Pasajero	18A	18CA	45EC		
Land Rover							
Discovery							
2019		Trasera					A334H
2016-14		Frontal		22CA	55EC	5555EC	
		Frontal Conductor	22A				
		Frontal Pasajero	22B				
1998-97		Trasera			40EC		
		Frontal	18A	18CA	45EC	4545EC	
		Trasera			34EC		
Discovery Sport							
2017-15		Frontal Conductor	26A	26CA	65EC		
		Frontal Pasajero	20B	20CA	50EC		
		Trasera					H309
Freelander							
2006		Frontal Conductor	22A	22CA	55EC		
		Frontal Pasajero	20A	20CA	50EC		
2005		Frontal Conductor	22A	22CA	55EC		
		Frontal Pasajero	21A	21CA	53EC		
2004		Frontal Conductor	22A	22CA	55EC		
		Frontal Pasajero	21B	21CA	53EC		
2003-02		Frontal Conductor	22A	22CA	55EC		
		Frontal Pasajero	21A	21CA	53EC		
2001-99		Frontal Conductor	22A	22CA	55EC		
		Frontal Pasajero	20A	20CA	50EC		
LR2							
2015		Frontal Conductor	24OE	24CA			
		Frontal Pasajero	20OE	20CA			
2014-08		Frontal Conductor	24OE	24CA			
		Frontal Pasajero	20OE	20CA			
		Trasera			34EC		

**K
L**



	Ubicación	Pluma Plana		Convencional		Traseras Especiales
		ICON	Clear Advantage	ECO	ECO Set	
Land Rover (cont'd.)						
LR3						
2008-05	Frontal	22A	22CA	55EC	5555EC	
	Trasera			40EC		
LR4						
2013-10	Frontal		22CA	55EC	5555EC	
	Frontal Conductor	22A				
	Frontal Pasajero	22B				
	Trasera			40EC		
Range Rover						
2019-17	Trasera					A425H
2016-13	Frontal Conductor	24A	24CA	60EC		
	Frontal Pasajero	20B	20CA	50EC		
	Trasera			42EC		
2012-03	Trasera			45EC		
2001-97	Frontal		22CA	55EC	5555EC	
	Frontal Conductor	22A				
	Frontal Pasajero	22B				
	Trasera			48EC		
Range Rover Evoque						
2019-17	Frontal Conductor	24OE	24CA			
	Frontal Pasajero	21OE	21CA			
	Trasera					H251
2016-12	Frontal Conductor	24OE	24CA			
	Frontal Pasajero	22OE	22CA			
	Trasera					H251
Range Rover Sport						
2019-17	Trasera					A381H
2016-14	Frontal Conductor	24A	24CA	60EC		
	Frontal Pasajero	20B	20CA	50EC		
2013-06	Frontal		22CA	55EC	5555EC	
	Frontal Conductor	22A				
	Frontal Pasajero	22B				
	Trasera			40EC		
Range Rover Velar						
2019-18	Frontal Conductor	26A				
	Frontal Pasajero	19A				
	Trasera					A334H
Lincoln						
Aviator						
2005	Frontal	20A	20CA	50EC	5050EC	
2004-03	Frontal	22A	22CA	55EC	5555EC	
Blackwood						
2003	Frontal	20A	20CA	50EC	5050EC	
Continental						
2019-18	Frontal Conductor	24OE	24CA			
	Frontal Pasajero	20OE	20CA			
1999	Frontal Conductor	24A	24CA	60EC		
	Frontal Pasajero	20A	20CA	50EC		
1998-97	Frontal	20A	20CA	50EC	5050EC	
LS						
2006-00	Frontal Conductor	24A	24CA	60EC		
	Frontal Pasajero	19A	19CA	48EC		
Mark LT						
2014-10	Frontal	20A	20CA	50EC	5050EC	
2008-06	Frontal		20CA	50EC	5050EC	
	Frontal Conductor	20A				
	Frontal Pasajero	20B				
Mark VIII						
1996-95	Frontal	22A	22CA	55EC	5555EC	
MKC						
2019-15	Frontal Conductor	26OE	26CA			
	Frontal Pasajero	15OE	15CA			
	Trasera					A281H
MKS						
2014-09	Frontal Conductor	26OE	26CA			
	Frontal Pasajero	20OE	20CA			
MKX						
2018-16	Frontal Conductor	24OE	24CA			
	Frontal Pasajero	18OE	18CA			
	Trasera					A281H



		Ubicación	Pluma Plana		Convencional		Traseras Especiales
			ICON	Clear Advantage	ECO	ECO Set	
Lincoln (cont'd.)							
MKX (cont'd.)							
2015-07	Frontal Conductor		26A	26CA	65EC		
	Frontal Pasajero		20B	20CA	50EC		
	Trasera						H353
MKZ							
2019-13	Frontal Conductor		22OE	22CA			
	Frontal Pasajero		20OE	20CA			
2012-07	Frontal Conductor		24A	24CA	60EC		
	Frontal Pasajero		19B	19CA	48EC		
Navigator							
2018	Frontal			22CA	55EC	5555EC	
	Frontal Conductor		22A				
	Frontal Pasajero		22B				
2017-09	Trasera, Remueva el adaptador						A281H
	Frontal			22CA	55EC	5555EC	
2008	Frontal Conductor		22A				
	Frontal Pasajero		22B				
2007-03	Frontal			22CA	55EC	5555EC	
	Frontal Conductor		22A				
2002-98	Frontal Pasajero		22B				
	Trasera				40EC		
2007-03	Frontal			20CA	50EC	5050EC	
	Frontal Conductor		20A				
2002-98	Frontal Pasajero		20B				
	Trasera				42EC		
2002-98	Frontal			20CA	50EC	5050EC	
	Frontal Conductor		20A				
2002-98	Frontal Pasajero		20B				
	Trasera				40EC		
Town Car							
2007-01	Frontal			22CA	55EC	5555EC	
	Frontal Conductor		22A				
	Frontal Pasajero		22B				
2000-95	Frontal		22A	22CA	55EC	5555EC	
1994-93	Frontal			22CA	55EC	5555EC	
	Frontal Conductor		22A				
1992-91	Frontal Pasajero		22B				
1992-91	Frontal			22CA	55EC	5555EC	
Zephyr							
2006	Frontal Conductor		24A	24CA	60EC		
	Frontal Pasajero		19B	19CA	48EC		
Lotus							
Elise							
2006-05	Centro		26A	26CA	65EC		
Exige							
2007-06	Centro		26A	26CA	65EC		
Maserati							
3200 GT							
2003-99	Frontal		20A	20CA	50EC	5050EC	
Ghibli							
2019	Frontal Conductor		26OE	26CA			
	Frontal Pasajero		18OE	18CA			
2017-14	Frontal Conductor		26OE	26CA			
	Frontal Pasajero		18OE	18CA			
GranCabrio							
2014-13	Frontal Conductor		26A	26CA	65EC		
	Frontal Pasajero		17A	17CA	42EC		
2011-10	Frontal Conductor		26A	26CA	65EC		
	Frontal Pasajero		17A	17CA	42EC		
GranSport							
2008	Frontal		22A	22CA	55EC	5555EC	
2006	Frontal			22CA	55EC	5555EC	
	Frontal Conductor		22A				
	Convertible	Frontal Pasajero		22A			
2006	Coupe	Frontal Pasajero		22B			
GranTurismo							
2017	Frontal Conductor		26A	26CA	65EC		
	Frontal Pasajero		17A	17CA	42EC		
2016-13	Frontal Conductor		26OE	26CA			
	Frontal Pasajero		17OE	17CA			





		Ubicación	Pluma Plana		Convencional		Traseras Especiales
			ICON	Clear Advantage	ECO	ECO Set	
Maserati (cont'd.)							
GranTurismo (cont'd.)							
2012-10		Frontal Conductor	26A	26CA	65EC		
		Frontal Pasajero	17B	17CA	42EC		
Levante							
2019-17		Frontal Conductor	26OE	26CA			
		Frontal Pasajero	18OE	18CA			
Quattroporte							
2019-14		Frontal Conductor	26OE	26CA			
		Frontal Pasajero	18OE	18CA			
2003-99		Frontal Conductor	26A	26CA	65EC		
		Frontal Pasajero	18A	18CA	45EC		
Spyder							
2004		Frontal		22CA	55EC	5555EC	
		Frontal Conductor	22A				
		Frontal Pasajero	22B				
Maybach							
57							
2009-03		Frontal	28AOE	28CA			
62							
2009-03		Frontal	28AOE	28CA			
Mazda							
2							
2017-15		Frontal Conductor	22A	22CA	55EC		
		Frontal Pasajero	16A	16CA	40EC		
2014-12		Frontal Conductor	24A	24CA	60EC		
		Frontal Pasajero	13A	13CA	34EC		
		Trasera					H354
3							
2018-15		Frontal Conductor	24A	24CA	60EC		
		Frontal Pasajero	18B	18CA	45EC		
	Hatchback	Trasera, Para vehículos producidos en Japón					H290
		Trasera, Para vehículos producidos en México					H306
2014		Frontal Conductor	24A	24CA	60EC		
		Frontal Pasajero	18A	18CA	45EC		
	Hatchback	Trasera, Para vehículos producidos en Japón					H290
		Trasera, Para vehículos producidos en México					H306
2013-10		Frontal Conductor	24A	24CA	60EC		
	Hatchback	Frontal Pasajero	19B	19CA	48EC		
		Trasera					H352
2009-08		Frontal Conductor	24A	24CA	60EC		
	Hatchback	Frontal Pasajero	19B	19CA	48EC		
		Trasera					H353
2007-06		Frontal				5347EC	
		Frontal Conductor	21A	21CA	53EC		
	Hatchback	Frontal Pasajero	19B	19CA	48EC		
		Trasera					H353
5							
2015-12		Frontal Conductor	26A	26CA	65EC		
		Frontal Pasajero	16A	16CA	40EC		
		Trasera					H309
2010-06		Frontal Conductor	26A	26CA	65EC		
		Frontal Pasajero	16A	16CA	40EC		
		Trasera					H307
6							
2017-09		Frontal Conductor	24A	24CA	60EC		
		Frontal Pasajero	18B	18CA	45EC		
2008-06		Frontal Conductor	22A	22CA	55EC		
		Frontal Pasajero	18A	18CA	45EC		
CX-3							
2019-16		Frontal Conductor	22A	22CA	55EC		
		Frontal Pasajero	19B	19CA	48EC		
		Trasera					H250
CX-5							
2019-17		Trasera					H352



		Ubicación	Pluma Plana		Convencional		Traseras Especiales
			ICON	Clear Advantage	ECO	ECO Set	
Mazda (cont'd.)							
CX-5 (cont'd.)							
2016-13		Frontal Conductor	24A	24CA	60EC		
		Frontal Pasajero	18B	18CA	45EC		
		Trasera					H352
CX-7							
2012-07		Frontal Conductor	26A	26CA	65EC		
		Frontal Pasajero	16A	16CA	40EC		
		Trasera					H352
CX-9							
2019-16		Trasera					H352
2015-07		Frontal Conductor	26A	26CA	65EC		
		Frontal Pasajero	17A	17CA	42EC		
		Trasera					H352
MX-5							
2019-17		Frontal	18A	18CA	45EC	4545EC	
2015-06		Frontal		18CA	45EC	4545EC	
		Frontal Conductor	18A				
		Frontal Pasajero	18B				
Mercedes-Benz							
A190							
2005		Frontal Conductor	24OE	24CA			
		Frontal Pasajero	19OE	19CA			
2004-01		Frontal Conductor	26A	26CA	65EC		
		Frontal Pasajero	24A	24CA	60EC		
A Class							
2016-13		Frontal Conductor	24OE	24CA			
		Frontal Pasajero	19OE	19CA			
2005-00		Frontal Conductor	26A	26CA	65EC		
		Frontal Pasajero	24A	24CA	60EC		
B Class							
2014-12		Frontal Conductor	26OE	26CA			
		Frontal Pasajero	19OE	19CA			
2011-06		Frontal Conductor	26OE	26CA			
		Frontal Pasajero	22OE	22CA			
		Trasera					H301
C Class							
2015-14		Frontal	24OE	24CA			
2013		Frontal, Al numero de chasis A819618	22OE	22CA			
		Frontal	24OE	24CA			
		Frontal	26OE	26CA			
		Frontal, Al numero de chasis A819618	22OE	22CA			
2012		Frontal, Al numero de chasis G103134	22OE	22CA			
		Frontal	26OE	26CA	45EC	4545EC	
2011-10		Frontal Conductor	18A				
		Frontal Pasajero	18B				
2009		Frontal	24OE	24CA			
2008-01		Frontal	26OE	26CA			
2008-01		Frontal	28AOE	28CA			
		Frontal	24A	24CA	60EC	6060EC	
1996		Centro	22A	22CA	55EC		
1995		Centro	22A	22CA	55EC		
CLA180							
2015	Sedan	Frontal	28AOE	28CA			
CLA Class							
2016-13		Frontal Conductor	24OE	24CA			
		Frontal Pasajero	19OE	19CA			
CL Class							
2013-09		Frontal	26OE	26CA			
2008-01		Frontal	28AOE	28CA			
CLK Class							
2003-00		Centro	22A	22CA	55EC		
1999		Centro	22A	22CA	55EC		
	Coupe	Centro	22A	22CA	55EC		
1998	Convertible	Frontal	22A	22CA	55EC	5555EC	
	Coupe	Centro	22A	22CA	55EC		
1997	Convertible	Frontal	22A	22CA	55EC	5555EC	

M

		Ubicación	Pluma Plana		Convencional		Traseras Especiales
			ICON	Clear Advantage	ECO	ECO Set	
Mercedes-Benz (cont'd.)							
CLS Class							
2018-17		Frontal	24OE	24CA			
2014		Frontal	24OE	24CA			
	Wagon	Frontal	24OE	24CA			
2013-12		Frontal	24OE	24CA			
2011		Frontal	24OE	24CA			
		Frontal	28OE	28CA			
2010-05		Frontal	28OE	26CA			
E Class							
2017-15		Frontal	24OE	24CA			
2014		Frontal	24OE	24CA			
	Convertible, Coupe	Frontal	24OE	24CA			
2013-12		Frontal	24OE	24CA			
2011		Frontal	24OE	24CA			
	Coupe, Sedan	Frontal	24OE	24CA			
2010		Frontal	24OE	24CA			
2009		Frontal	24OE	24CA			
		Frontal	26OE	26CA			
2008-03		Frontal	26OE	26CA			
2002-00		Centro	24A	24CA	60EC		
1999-97		Frontal	24A	24CA	60EC	6060EC	
		Centro	24A	24CA	60EC		
1996-94		Centro	24A	24CA	60EC		
G Class							
2018-15		Frontal	16A	16CA	40EC	4040EC	
2014		Frontal	16A	16CA	40EC	4040EC	
		Trasera					H301
2013-99		Frontal	16A	16CA	40EC	4040EC	
GLA Class							
2015-14		Frontal Conductor	24OE	24CA			
		Frontal Pasajero	19OE	19CA			
GLC Class							
2018-16		Trasera					A334H
GL Class							
2015-13		Frontal Conductor		26CA			
		Trasera					H301
2012-07		Frontal Conductor	28AOE	28CA			
		Frontal Pasajero	21OE	21CA			
		Trasera					H301
GLE Class							
2018-16		Frontal Conductor		26CA			
		Trasera					H301
GLK Class							
2015-10		Frontal Conductor	22OE	22CA			
		Frontal Pasajero	19OE	19CA			
		Trasera					H301
2009		Frontal Conductor	22OE	22CA			
		Frontal Pasajero	19OE	19CA			
GLS Class							
2018-17		Frontal Conductor		26CA			
		Trasera					H301
M Class							
2015-12		Frontal Conductor		26CA			
		Trasera					H301
2011-06		Frontal Conductor	28AOE	28CA			
		Frontal Pasajero	21OE	21CA			
		Trasera					H301
2005-03		Frontal		22CA	55EC	5555EC	
		Frontal Conductor	22A				
		Frontal Pasajero	22B				
		Trasera			42EC		
2002-01		Frontal	22A	22CA	55EC	5555EC	
		Frontal Conductor	22A				
		Frontal Pasajero	22B				
		Trasera			42EC		
2000		Frontal	22A	22CA	55EC	5555EC	
		Trasera			42EC		
1999-98		Frontal	22A	22CA	55EC	5555EC	
		Trasera			40EC		

M

		Ubicación	Pluma Plana		Convencional		Traseras Especiales
			ICON	Clear Advantage	ECO	ECO Set	
Mercedes-Benz (cont'd.)							
R Class							
2013-06	Frontal Conductor		28AOE	28CA			
	Frontal Pasajero		21OE	21CA			
	Trasera						H301
S Class							
2017-15	Frontal Conductor, Solo vehículos de de pasajeros sin water jet en la pluma		24OE	24CA			
	Frontal Pasajero, Solo vehículos de de pasajeros sin water jet en la pluma		22OE	22CA			
2014-06	Frontal		26OE	26CA			
2005	Frontal		26OE	26CA			
	Frontal		28AOE	28CA			
2004-01	Frontal		26OE	26CA			
2000	Frontal Conductor, Desde Marzo 2000		26OE	26CA			
	Frontal Conductor		28A	28CA	70EC		
	Frontal Pasajero		24A	24CA	60EC		
	Frontal Pasajero, Desde Marzo 2000		28AOE	28CA			
1999	Frontal Conductor		28A	28CA	70EC		
	Frontal Pasajero		24A	24CA	60EC		
SLC Class							
2017	Frontal		22OE	22CA			
SL Class							
2012-01	Frontal		26OE	26CA			
2000	Centro		22A	22CA	55EC		
1999-97	Frontal		22A	22CA	55EC	5555EC	
	Centro		22A	22CA	55EC		
1996	Centro		22A	22CA	55EC		
SLK Class							
2016-08	Frontal		22OE	22CA			
2007-05	Frontal		22OE	22CA	55EC	5555EC	
	Frontal Conductor		22A				
	Frontal Pasajero		22B				
2004-03	Frontal			22CA	55EC	5555EC	
	Frontal Conductor		22A	22CA	55EC		
	Frontal Pasajero		22B	21CA	53EC		
2002-98	Frontal			22CA	55EC	5555EC	
	Frontal Conductor		22A				
	Frontal Pasajero		22B				
1997	Frontal Conductor		22A	22CA	55EC		
	Frontal Pasajero		21A	21CA	53EC		
SLR McLaren							
2009-07	Frontal		26OE	26CA			
SLS AMG							
2014-13	Frontal		26OE	26CA			
2011	Frontal		26OE	26CA			
Sprinter							
2018	Frontal Conductor		26OE	26CA			
	Frontal Pasajero		24OE	24CA			
2017	Frontal Conductor		26OE	26CA			
	Frontal Pasajero		24OE	24CA			
	Trasera				38EC		
2016	Frontal Conductor		26OE	26CA			
	Frontal Pasajero		24OE	24CA			
2012-04	Frontal Conductor		26OE	26CA			
	Frontal Pasajero		24OE	24CA			
Viano							
2015-13	Frontal Conductor		28AOE	28CA			
	Frontal Pasajero		26OE	26CA			
Vito							
2012-10	Frontal Conductor		28A	28CA	70EC		
	Frontal Pasajero		26A	26CA	65EC		
2009	Frontal Conductor		28AOE	28CA			
	Frontal Pasajero		26OE	26CA			

M

		Ubicación	Pluma Plana		Convencional		Traseras Especiales
			ICON	Clear Advantage	ECO	ECO Set	
Mercury							
Mariner							
2011-08		Frontal	20OE	20CA			
		Trasera					H300
2007-05		Frontal Conductor	20A	20CA	50EC		
		Frontal Pasajero	18A	18CA	45EC		
		Trasera					H251
Milan							
2008-07		Frontal Conductor	24A	24CA	60EC		
		Frontal Pasajero	19B	19CA	48EC		
Montego							
2007-05		Frontal Conductor	24OE	24CA			
		Frontal Pasajero	20OE	20CA			
Sable							
2004-02		Frontal Conductor	24A	24CA	60EC		
		Frontal Pasajero	20B	20CA	50EC		
MG							
TF							
2005-03		Frontal	20A	20CA	50EC	5050EC	
ZR							
2005-04		Frontal Conductor	22A	22CA	55EC		
		Frontal Pasajero	21A	21CA	53EC		
ZT							
2005		Frontal Conductor	22A	22CA	55EC		
		Frontal Pasajero	21A	21CA	53EC		
2003		Frontal Conductor	22A	22CA	55EC		
		Frontal Pasajero	21A	21CA	53EC		
Mini							
Cooper							
2019-17		Frontal Conductor	18A	18CA	45EC		
		Frontal Pasajero	19A	19CA	48EC		
2016-15	Hatchback	Trasera					H240
		Convertible	Frontal Conductor	18A	18CA	45EC	
		Frontal Pasajero	19A	19CA	48EC		
	Coupe	Frontal	20OE	20CA			
		Hatchback	Frontal Conductor	18A	18CA	45EC	
		Frontal Pasajero	19A	19CA	48EC		
2014-13	Coupe	Frontal	20OE	20CA			
		Hatchback	Trasera				H240
	Wagon	Trasera					A280H
2012	Coupe	Frontal	20OE	20CA			
		Hatchback	Trasera				H240
	Wagon	Frontal Conductor	18A	18CA	45EC		
		Frontal Pasajero	19B	19CA	48EC		
		Trasera					A280H
2011	Convertible	Frontal Conductor	18A	18CA	45EC		
		Frontal Pasajero	19B	19CA	48EC		
	Wagon	Frontal Conductor	18A	18CA	45EC		
Frontal Pasajero		19B	19CA	48EC			
		Trasera					A280H
2010	Hatchback	Frontal Conductor	18A	18CA	45EC		
		Frontal Pasajero	19B	19CA	48EC		
	Wagon	Trasera					H240
		Trasera					A280H
2009-08	Convertible	Frontal Conductor	18A	18CA	45EC		
		Frontal Pasajero	19B	19CA	48EC		
	Hatchback	Frontal Conductor	18A	18CA	45EC		
Frontal Pasajero		19B	19CA	48EC			
		Trasera					H240
2007	Hatchback	Frontal Conductor	18A	18CA	45EC		
		Frontal Pasajero	19B	19CA	48EC		
		Trasera					H240
2006-05	Hatchback	Frontal Conductor	18A	18CA	45EC		
		Frontal Pasajero	19B	19CA	48EC		
			Trasera				
2004-02	Hatchback	Frontal Conductor	18A	18CA	45EC		
		Frontal Pasajero	19B	19CA	48EC		
Cooper Clubman							
2019-17		Frontal Conductor	21OE	22CA			
		Frontal Pasajero	20OE	20CA			
		Trasera					H250

M

		Ubicación	Pluma Plana		Convencional		Traseras Especiales
			ICON	Clear Advantage	ECO	ECO Set	
Mini (cont'd.)							
Cooper Countryman							
2020-17		Trasera					A250H
2013-11		Frontal Conductor	19OE	19CA			
		Frontal Pasajero	20OE	20CA			
		Trasera					H240
Cooper Paceman							
2014-13		Frontal Conductor	19OE	19CA			
		Frontal Pasajero	20OE	20CA			
		Trasera					A281H
Mitsubishi							
ASX							
2015-13		Frontal Conductor	24A	24CA	60EC		
		Frontal Pasajero	21A	21CA	53EC		
Eclipse							
2012-11		Frontal Conductor	24A	24CA	60EC		
		Frontal Pasajero	22B	22CA	55EC		
		Trasera			42EC		
2009		Frontal Conductor	24A	24CA	60EC		
		Frontal Pasajero	22B	22CA	55EC		
		Trasera			42EC		
2008-06		Frontal Conductor	24A	24CA	60EC		
		Frontal Pasajero	22B	22CA	55EC		
		Trasera			42EC		
2005-03	Coupe	Frontal Conductor	24A	24CA	60EC		
		Frontal Pasajero	21A	21CA	53EC		
	Coupe	Trasera			55EC		
Endeavor							
2011-10		Frontal Conductor	26A	26CA	65EC		
		Frontal Pasajero	21B	21CA	53EC		
		Trasera					H307
2009		Frontal Conductor	26A	26CA	65EC		
		Frontal Pasajero	21A	21CA	53EC		
		Trasera					
2008-04		Frontal Conductor	26A	26CA	65EC		
		Frontal Pasajero	21A	21CA	53EC		
		Trasera					H352
Galant							
2009-04		Frontal Conductor	26A	26CA	65EC		
		Frontal Pasajero	19A	19CA	48EC		
2003		Frontal Conductor	24A	24CA	60EC		
		Frontal Pasajero	18A	18CA	45EC		
Grandis							
2009-08		Frontal Conductor	28A	28CA	70EC		
		Frontal Pasajero	22A	22CA	55EC		
2007		Frontal Conductor	28A	28CA	70EC		
		Frontal Pasajero	21A	21CA	53EC		
L200							
2017-08		Frontal	19A	19CA	48EC	4747EC	
Lancer							
2016-08		Frontal Conductor	26A	26CA	65EC		
		Frontal Pasajero	18A	18CA	45EC		
2007-04		Frontal Conductor	24A	24CA	60EC		
		Frontal Pasajero	18A	18CA	45EC		
Mirage							
2019-15		Frontal Conductor	24A	24CA	60EC		
		Frontal Pasajero	16A	16CA	40EC		
		Trasera					H307
Montero							
2017-08		Frontal Conductor	22A	22CA	55EC		
		Frontal Pasajero	20A	20CA	50EC		
2006-03		Frontal		20CA	50EC	5050EC	
		Frontal Conductor	20A				
		Frontal Pasajero	20B				
		Trasera			40EC		
Montero Sport							
2015-10		Frontal Conductor	22A	22CA	55EC		
		Frontal Pasajero	20A	20CA	50EC		
2008-07		Frontal Conductor	22A	22CA	55EC		
		Frontal Pasajero	20A	20CA	50EC		
2006-05		Frontal	20A	20CA	50EC	5050EC	

M

		Ubicación	Pluma Plana		Convencional		Traseras Especiales
			ICON	Clear Advantage	ECO	ECO Set	
Mitsubishi (cont'd.)							
Montero Sport (cont'd.)							
2004-03		Frontal		20CA	50EC	5050EC	
		Frontal Conductor	20A				
		Frontal Pasajero	20B				
		Trasera			42EC		
Outlander							
2019-14		Frontal Conductor	26A	26CA	65EC		
		Frontal Pasajero	18A	18CA	45EC		
		Trasera					H306
2013-08		Frontal Conductor	24A	24CA	60EC		
		Frontal Pasajero	21B	21CA	53EC		
		Trasera					H306
Nissan							
240SX							
1998		Frontal Conductor	21A	21CA	53EC		
		Frontal Pasajero	20A	20CA	50EC		
1993		Frontal	20A	20CA	50EC	5050EC	
		Trasera			50EC		
300ZX							
1996-91		Frontal	21A	21CA	53EC	5353EC	
350Z							
2008-03		Frontal Conductor	20A	20CA	50EC		
		Frontal Pasajero	18B	18CA	45EC		
370Z							
2019		Frontal Conductor	22A	22CA	55EC		
		Frontal Pasajero	19A	19CA	48EC		
2017-09		Frontal				5347EC	
		Frontal Conductor	21A	21CA	53EC		
		Frontal Pasajero	19B	19CA	48EC		
Almera							
2005-01		Frontal Conductor	22A	22CA	55EC		
		Frontal Pasajero	16A	16CA	40EC		
Altima							
2018-13		Frontal Conductor	28A	28CA	70EC		
		Frontal Pasajero	16A	16CA	40EC		
2012-07		Frontal Conductor	28A	28CA	70EC		
		Frontal Pasajero	17B	17CA	42EC		
2006-02		Frontal Conductor	26A	26CA	65EC		
		Frontal Pasajero	17A	17CA	42EC		
2001-96		Frontal Conductor	21A	21CA	53EC		
		Frontal Pasajero	20B	20CA	50EC		
Aprio							
2010-08		Frontal	20A	20CA	50EC	5050EC	
Armada							
2019		Frontal Conductor	24A	24CA	60EC		
		Frontal Pasajero	20A	20CA	50EC		
		Trasera					H306
2018-17		Frontal Conductor	24A	24CA	60EC		
		Frontal Pasajero	19A	19CA	48EC		
		Trasera					H306
2015		Frontal Conductor	24A	24CA	60EC		
		Frontal Pasajero	22A	22CA	55EC		
		Trasera					H306
2014-05		Frontal Conductor	24A	24CA	60EC		
		Frontal Pasajero	22B	22CA	55EC		
		Trasera					H306
Cabstar							
2016-11		Frontal	20A	20CA	50EC	5050EC	
2009-08		Frontal	20A	20CA	50EC	5050EC	
Cabstar E							
2009-08		Frontal	20A	20CA	50EC	5050EC	
Frontier							
2019-06		Frontal Conductor	24A	24CA	60EC		
		Frontal Pasajero	18A	18CA	45EC		
2004-01		Frontal	19A	19CA	48EC	4747EC	
GT-R							
2018-17		Frontal	22A	22CA	55EC	5555EC	
Hikari							
1992-88		Frontal				5347EC	
		Frontal Conductor	21A	21CA	53EC		
		Frontal Pasajero	19A	19CA	48EC		

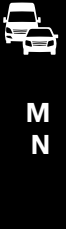

		Ubicación	Pluma Plana		Convencional		Traseras Especiales
			ICON	Clear Advantage	ECO	ECO Set	
Nissan (cont'd.)							
Ichi Van							
1994-90		Frontal				4742EC	
		Frontal Conductor	19A	19CA	48EC		
		Frontal Pasajero	18A	18CA	45EC		
Juke							
2017-12		Frontal Conductor	22A	22CA	55EC		
		Frontal Pasajero	13A	13CA	34EC		
		Trasera					H301
Kicks							
2020-17		Frontal Conductor	26A	26CA	65EC		
		Frontal Pasajero	13A	13CA	34EC		
Leaf							
2017-12		Frontal Conductor	26A	26CA	65EC		
		Frontal Pasajero	16A	16CA	40EC		
		Trasera					H250
Lucino							
2000-96		Frontal				5347EC	
		Frontal Conductor	21A	21CA	53EC		
		Frontal Pasajero	19A	19CA	48EC		
March							
2017-16		Frontal Conductor	24A	24CA	60EC		
		Frontal Pasajero	13A	13CA	34EC		
		Trasera					H306
2015-12		Frontal Conductor	21A	21CA	53EC		
		Frontal Pasajero	13A	13CA	34EC		
Maxima							
2019-16		Frontal Conductor	28A	28CA			
		Frontal Pasajero	16A	16CA	40EC		
2015-09		Frontal Conductor	28A	28CA	70EC		
		Frontal Pasajero	17A	17CA	42EC		
2008-00		Frontal Conductor	26A	26CA	65EC		
		Frontal Pasajero	17A	17CA	42EC		
1999-95		Frontal Conductor	22A	22CA	55EC		
		Frontal Pasajero	21A	21CA	53EC		
1993-91		Frontal Conductor	21A	21CA	53EC		
		Frontal Pasajero	20B	20CA	50EC		
Micra							
2007-05		Frontal Conductor	21A	21CA	53EC		
		Frontal Pasajero	18A	18CA	45EC		
Murano							
2019		Frontal Conductor	26A	26CA	65EC		
		Frontal Pasajero	18A	18CA	45EC		
		Trasera					H306
2014-09		Frontal Conductor	26A	26CA	65EC		
		Frontal Pasajero	16A	16CA	40EC		
		Trasera					H306
2008		Frontal Conductor	26A	26CA	65EC		
		Frontal Pasajero	18A	18CA	45EC		
2007-04		Frontal Conductor	26A	26CA	65EC		
		Frontal Pasajero	18A	18CA	45EC		
		Trasera					H354
Note							
2019		Frontal Conductor	28A	28CA	70EC		
2018-15		Frontal Conductor	28A	28CA	70EC		
		Trasera					H306
2014		Frontal Conductor	26A	26CA	65EC		
		Frontal Pasajero	13A	13CA	34EC		
		Trasera					H306
NP300							
2017		Frontal	19A	19CA	48EC	4747EC	
2016	Cabina y Chasis, Pickup de tamaño estándar	Frontal	19A	19CA	48EC	4747EC	
2015-09		Frontal	19A	19CA	48EC	4747EC	
NP300 Frontier							
2017-16		Frontal Conductor	24A	24CA	60EC		
		Frontal Pasajero	18A	18CA	45EC		
NT400 Cabstar							
2018-17		Frontal	20A	20CA	50EC	5050EC	
NV350 Urvan							
2017-14		Frontal Conductor	22A	22CA	55EC		
		Frontal Pasajero	16A	16CA	40EC		



	Ubicación	Pluma Plana		Convencional		Traseras Especiales
		ICON	Clear Advantage	ECO	ECO Set	
Nissan (cont'd.)						
NV2500						
2015-13	Frontal	21A	21CA	53EC	5353EC	
Pathfinder						
2018-13	Frontal Conductor	26A	26CA	65EC		
	Frontal Pasajero	17A	17CA	42EC		
	Trasera					H301
2012-05	Frontal Conductor	24A	24CA	60EC		
	Frontal Pasajero	18A	18CA	45EC		
	Trasera					H306
2004-97	Frontal Conductor	22A	22CA	55EC		
	Frontal Pasajero	21A	21CA	53EC		
	Trasera					H251
Pickup						
2008-95	Frontal	19A	19CA	48EC	4747EC	
1994-93	Frontal		19CA	48EC	4747EC	
	Frontal Conductor	19A				
	Frontal Pasajero	19B				
Platina						
2007-02	Frontal Conductor	21A	21CA	53EC		
	Frontal Pasajero	18A	18CA	45EC		
Quest						
2002-01	Frontal		22CA	55EC	5555EC	
	Frontal Conductor	22A				
	Frontal Pasajero	22B				
	Trasera			34EC		
2000-97	Frontal	22A	22CA	55EC	5555EC	
	Trasera			34EC		
Rogue						
2014	Frontal Conductor	26A	26CA	65EC		
	Frontal Pasajero	17A	17CA	42EC		
	Trasera					H301
2013-08	Frontal Conductor	26A	26CA	65EC		
	Frontal Pasajero	15A	15CA	38EC		
	Trasera					H301
Sentra						
2019-13	Frontal Conductor	28A	28CA			
	Frontal Pasajero	15A	15CA	38EC		
2012-07	Frontal Conductor	26A	26CA	65EC		
	Frontal Pasajero	17A	17CA	42EC		
2006-03	Frontal Conductor	22A	22CA	55EC		
	Frontal Pasajero	17A	17CA	42EC		
2002-00	Frontal Conductor	22A	22CA	55EC		
	Frontal Pasajero	16A	16CA	40EC		
1999-96	Frontal				5347EC	
	Frontal Conductor	21A	21CA	53EC		
	Frontal Pasajero	19A	19CA	48EC		
Tiida						
2018-12	Frontal Conductor	24A	24CA	60EC		
	Frontal Pasajero	13A	13CA	34EC		
2011	Frontal Conductor	26A	26CA	65EC		
	Frontal Pasajero	13A	13CA	34EC		
2010	Frontal Conductor	26A	26CA	65EC		
	Frontal Pasajero	13A	13CA	34EC		
2009	Hatchback	Trasera				H353
	Frontal Conductor	26A	26CA	65EC		
2008	Frontal Pasajero	13A	13CA	34EC		
	Frontal Conductor	26A	26CA	65EC		
2007	Hatchback	Trasera				H353
	Frontal Conductor	26A	26CA	65EC		
	Frontal Pasajero	13A	13CA	34EC		
Titan						
2015-14	Frontal Conductor	24A	24CA	60EC		
	Frontal Pasajero	22A	22CA	55EC		
2013-04	Frontal Conductor	24A	24CA	60EC		
	Frontal Pasajero	22B	22CA	55EC		
Tsubame						
2004-93	Frontal				5347EC	
	Frontal Conductor	21A	21CA	53EC		
	Frontal Pasajero	19A	19CA	48EC		
Tsuru						
2017-98	Frontal	18A	18CA	45EC	4545EC	

N

			Pluma Plana		Convencional		Traseras Especiales
			ICON	Clear Advantage	ECO	ECO Set	
Ubicación							
Nissan (cont'd.)							
Tsuru (cont'd.)							
1997	Sedan	Frontal	18A	18CA	45EC	4545EC	
1996-95	Coupe	Frontal	19A	19CA	48EC	4747EC	
	Sedan	Frontal	18A	18CA	45EC	4545EC	
1994-92		Frontal	18A	18CA	45EC	4545EC	
1991	Sedan	Frontal	18A	18CA	45EC	4545EC	
	Wagon	Frontal	19A	19CA	48EC	4747EC	
1990-87		Frontal Pasajero	18A	18CA	45EC		
	Sedan	Frontal				4545EC	
		Frontal Conductor	18A	18CA	45EC		
	Wagon	Frontal				4742EC	
		Frontal Conductor	19A	19CA	48EC		
1986-85		Frontal	18A	18CA	45EC	4545EC	
1984	Sedan	Frontal	18A	18CA	45EC	4545EC	
Urvan							
2013-09		Frontal	19A	19CA	48EC	4747EC	
2008-00		Frontal				5347EC	
		Frontal Conductor	21A	21CA	53EC		
		Frontal Pasajero	19A	19CA	48EC		
V-Drive							
2020		Frontal Conductor	21A	21CA	53EC		
		Frontal Pasajero	13A	13CA	34EC		
Versa							
2019-12		Frontal Conductor	21A	21CA	53EC		
		Frontal Pasajero	13A	13CA	34EC		
Xterra							
2007-05		Frontal Conductor	24A	24CA	60EC		
		Frontal Pasajero	18A	18CA	45EC		
		Trasera					H306
2004-00		Frontal	19A	19CA	48EC	4747EC	
X-Trail							
2017-14		Frontal Conductor	26A	26CA	65EC		
		Frontal Pasajero	16A	16CA	40EC		
2013-08		Frontal Conductor	24A	24CA	60EC		
		Frontal Pasajero	16A	16CA	40EC		
2007		Frontal Conductor	24A	24CA	60EC		
		Frontal Pasajero	13A	13CA	34EC		
		Trasera			42EC		
2006-05		Frontal Conductor	24A	24CA	60EC		
		Frontal Pasajero	13A	13CA	34EC		
		Trasera					H306
2004-02		Frontal Conductor	24A	24CA	60EC		
		Frontal Pasajero	13A	13CA	34EC		
		Trasera			42EC		
Oldsmobile							
88							
1995-92		Frontal		22CA			
Cutlass							
1996-89		Frontal		20CA			
1988		Frontal		18CA			
1987		Frontal		18CA	45EC	4545EC	
Silhouette							
1995-91		Frontal		24CA	60EC	6060EC	
		Trasera			34EC		
Peugeot							
206							
2009-08		Frontal Conductor	26A	26CA	65EC		
		Frontal Pasajero	16A	16CA	40EC		
2007-02	Hatchback	Frontal Conductor	26A	26CA	65EC		
		Frontal Pasajero	16A	16CA	40EC		
2001-00		Frontal Conductor	26A	26CA	65EC		
		Frontal Pasajero	16A	16CA	40EC		
207							
2014		Frontal Conductor	26OE	26CA			
		Frontal Pasajero	17OE	17CA			
2013-10	Convertible	Frontal Conductor	26OE	26CA			
		Frontal Pasajero	17OE	17CA			
208							
2018-16		Frontal Conductor	26OE	26CA			
		Frontal Pasajero	15OE	16CA			
		Trasera					H300



**P
O
N**

		Pluma Plana		Convencional		
		ICON	Clear Advantage	ECO	ECO Set	Traseras Especiales
Ubicación						
Peugeot (cont'd.)						
208 (cont'd.)						
2015-14		Frontal Conductor	26OE	26CA		
		Frontal Pasajero	15OE	16CA		
208 GT						
2017-16		Frontal Conductor	26OE	26CA		
		Frontal Pasajero	15OE	16CA		
		Trasera				H300
2015-14		Frontal Conductor	26OE	26CA		
		Frontal Pasajero	15OE	16CA		
306						
2002-01	Sedan	Frontal Conductor	22A	22CA	55EC	
		Frontal Pasajero	20A	20CA	50EC	
2000-98		Frontal Conductor	22A	22CA	55EC	
		Frontal Pasajero	20A	20CA	50EC	
307						
2010		Frontal Conductor	28AOE	28CA		
		Frontal Pasajero	26OE	26CA		
2009	Hatchback	Frontal Conductor	28AOE	28CA		
		Frontal Pasajero	26OE	26CA		
2008	Hatchback	Frontal Conductor	28AOE	28CA		
		Frontal Pasajero	26OE	26CA		
	Sedan	Frontal Conductor	28AOE	28CA		
		Frontal Pasajero	26OE	26CA		
2007	Sedan	Frontal Conductor	28AOE	28CA		
		Frontal Pasajero	26OE	26CA		
308						
2017-16		Frontal Conductor	24OE	24CA		
		Frontal Pasajero	18OE	18CA		
2014	Convertible	Frontal Conductor	28AOE	28CA		
		Frontal Pasajero	26OE	26CA		
2013	Convertible	Frontal Conductor	28AOE	28CA		
		Frontal Pasajero	26OE	26CA		
	Hatchback	Frontal Conductor	24OE	24CA		
		Frontal Pasajero	18OE	18CA		
2012		Frontal Pasajero	26OE	26CA		
	Convertible	Frontal Conductor	28AOE	28CA		
2011-10	Hatchback	Frontal Pasajero	26OE	26CA		
2009		Frontal Pasajero	26OE	26CA		
405						
1999-97		Frontal	22A	22CA	55EC	5555EC
406						
2005-01	Sedan	Frontal Conductor	24A	24CA	60EC	
		Frontal Pasajero	22A	22CA	55EC	
2000		Frontal Conductor	24A	24CA	60EC	
		Frontal Pasajero	22A	22CA	55EC	
508						
2017-12		Frontal	26OE	26CA		
2008						
2019		Frontal Conductor	26OE	26CA		
		Frontal Pasajero	15OE	16CA		
2016-14		Frontal Conductor	26OE	26CA		
		Frontal Pasajero	15OE	16CA		
5008						
2019		Frontal Conductor		28CA		
		Frontal Pasajero		16CA		
Expert						
2009-08		Frontal Conductor	26A	26CA	65EC	
		Frontal Pasajero	20A	20CA	50EC	
Grand Raid						
2012-08		Frontal Conductor	26OE	26CA		
		Frontal Pasajero	15OE	16CA		
Manager						
2016-09		Frontal Conductor	26OE	26CA		
		Frontal Pasajero	21OE	21CA		
Partner						
2017-13		Frontal Conductor	26OE	26CA		
		Frontal Pasajero	15OE	16CA		
2012-04		Frontal Conductor	22A	22CA	55EC	
		Frontal Pasajero	21A	21CA	53EC	
RCZ						
2016-11		Frontal	26OE	26CA		



				Pluma Plana		Convencional		
		Ubicación		ICON	Clear Advantage	ECO	ECO Set	Traseras Especiales
Pontiac								
Aztek								
2005-01		Frontal		24A	24CA	60EC	6060EC	
Bonneville								
1999-94		Frontal			22CA	55EC	5555EC	
Firebird								
2001-98		Frontal		24A	24CA	60EC	6060EC	
G3								
2009-07		Frontal Conductor		22A	22CA	55EC		
		Frontal Pasajero		18A	18CA	45EC		
G4								
2006-05		Frontal Conductor		22A	22CA	55EC		
		Frontal Pasajero		17A	17CA	42EC		
G5								
2009	Sedan	Frontal Conductor		22A	22CA	55EC		
		Frontal Pasajero		17A	17CA	42EC		
2008-07	Coupe	Frontal Conductor		22A	22CA	55EC		
		Frontal Pasajero		17A	17CA	42EC		
G6								
2009-05		Frontal Conductor		24OE	24CA			
		Frontal Pasajero		21OE	21CA			
Grand Am								
2004-99		Frontal Conductor		22A	22CA	55EC		
		Frontal Pasajero		17B	17CA	42EC		
Grand Prix								
2001-97		Frontal			22CA	55EC	5555EC	
		Frontal Conductor		22A				
		Frontal Pasajero		22B				
Matiz								
2010-04		Frontal Conductor		22A	22CA	55EC		
		Frontal Pasajero		13A	13CA	34EC		
Montana								
2009-05		Frontal Conductor		24A	24CA	60EC		
		Frontal Pasajero		22A	22CA	55EC		
		Trasera				40EC		
Solstice								
2009	Convertible	Frontal Conductor		16A	16CA	40EC		
		Frontal Pasajero		22B	22CA	55EC		
2008-06		Frontal Conductor		16A	16CA	40EC		
		Frontal Pasajero		22B	22CA	55EC		
Sunfire								
2005-04		Frontal Conductor		22A	22CA	55EC		
		Frontal Pasajero		17B	17CA	42EC		
2002-97		Frontal Conductor		22A	22CA	55EC		
		Frontal Pasajero		17B	17CA	42EC		
Torrent								
2009-06		Frontal Conductor		24A	24CA	60EC		
		Frontal Pasajero		19A	19CA	48EC		
		Trasera				38EC		
Porsche								
718 Boxster								
2018-17		Frontal		21OE				
		Frontal Conductor			21CA			
		Frontal Pasajero			22CA			
718 Cayman								
2018-17		Frontal		21OE				
		Frontal Conductor			21CA			
		Frontal Pasajero			22CA			
911								
2018-13		Frontal		21OE				
		Frontal Conductor			21CA			
		Frontal Pasajero			22CA			
2012	Convertible, Coupe	Frontal		21OE	22CA			
2011-09		Frontal			22CA	55EC	5555EC	
		Frontal Conductor		22A				
		Frontal Pasajero		22B				
2008-07	Convertible	Frontal			22CA	55EC	5555EC	
		Frontal Conductor		22A				
		Frontal Pasajero		22B				
	Coupe	Frontal			22CA	55EC	5555EC	
		Frontal Conductor		22A				



			Pluma Plana		Convencional		Traseras Especiales
			ICON	Clear Advantage	ECO	ECO Set	
Porsche (cont'd.)							
911 (cont'd.)							
2008-07		Frontal Pasajero	22B				
2006		Frontal		22CA	55EC	5555EC	
		Frontal Conductor	22A				
		Frontal Pasajero	22B				
2005-04	Convertible	Frontal		22CA	55EC	5555EC	
		Frontal Conductor	22A				
		Frontal Pasajero	22B				
	Coupe	Frontal		22CA	55EC	5555EC	
		Frontal Conductor	22A				
		Frontal Pasajero	22B				
2003-02	Coupe	Frontal		22CA	55EC	5555EC	
		Frontal Conductor	22A				
		Frontal Pasajero	22B				
2001		Frontal		22CA	55EC	5555EC	
		Frontal Conductor	22A				
		Frontal Pasajero	22B				
1999		Frontal		22CA	55EC	5555EC	
		Frontal Conductor	22A				
		Frontal Pasajero	22B				
918 Spyder							
2015		Frontal	21OE				
		Frontal Conductor		21CA			
		Frontal Pasajero		22CA			
Boxster							
2016-13		Frontal	21OE				
		Frontal Conductor		21CA			
		Frontal Pasajero		22CA			
2012-10		Frontal		22CA	55EC	5555EC	
		Frontal Conductor	22A				
		Frontal Pasajero	22B				
2008-05		Frontal		22CA	55EC	5555EC	
		Frontal Conductor	22A				
		Frontal Pasajero	22B				
2002-01		Frontal		22CA	55EC	5555EC	
		Frontal Conductor	22A				
		Frontal Pasajero	22B				
Carrera GT							
2006-04		Frontal		22CA	55EC	5555EC	
		Frontal Conductor	22A				
		Frontal Pasajero	22B				
Cayenne							
2017-12		Frontal	26OE	26CA			
		Trasera					A332H
2011-09		Frontal	26OE	26CA			
		Trasera					H772
2008		Trasera					H772
2006-03		Trasera					H772
Cayman							
2016-14		Frontal	21OE				
		Frontal Conductor		21CA			
		Frontal Pasajero		22CA			
2008-06		Frontal		22CA	55EC	5555EC	
		Frontal Conductor	22A				
		Frontal Pasajero	22B				
Macan							
2019-15		Frontal Conductor	24OE				
		Frontal Pasajero	20OE				
		Trasera					A381H
Panamera							
2019-17		Frontal Conductor	24OE	24CA			
		Frontal Pasajero	21OE	21CA			
		Trasera					A332H
2016-14		Frontal Conductor	26OE	26CA			
		Frontal Pasajero	20OE	20CA			
		Trasera					A381H
2013		Frontal Conductor	24A	24CA	60EC		
		Frontal Pasajero	20B	20CA	50EC		
		Trasera					A381H
2012-10		Frontal Conductor	22A	22CA	55EC		
		Frontal Pasajero	21B	21CA	53EC		
		Trasera					A381H



		Ubicación	Pluma Plana		Convencional		Traseras Especiales
			ICON	Clear Advantage	ECO	ECO Set	
Ram							
700							
2016-15	Pickup de tamaño estándar	Frontal		22CA	55EC	5555EC	
		Frontal Conductor	22A				
		Frontal Pasajero	22B				
H100 Van							
2014		Frontal Conductor	24A	24CA	60EC		
		Frontal Pasajero	20A	20CA	50EC		
ProMaster 1500							
2018-14		Frontal Conductor	26A	26CA	65EC		
		Frontal Pasajero	22B	22CA	55EC		
ProMaster 2500							
2018-14		Frontal Conductor	26A	26CA	65EC		
		Frontal Pasajero	22B	22CA	55EC		
ProMaster 3500							
2018-14		Frontal Conductor	26A	26CA	65EC		
		Frontal Pasajero	22B	22CA	55EC		
Ram Pickup (D, W Series)							
2019		Frontal	24A	24CA	60EC	5555EC	
		Frontal Conductor	22A				
		Frontal Pasajero	22B				
2018-10		Frontal		22CA	55EC	5555EC	
		Frontal Conductor	22A				
		Frontal Pasajero	22B				
Renault							
Alliance							
1986-84		Frontal		18CA	45EC	4545EC	
Captur							
2018		Trasera					H840
Clio							
2017		Trasera					A250H
2008-02		Frontal Conductor	21A	21CA	53EC		
		Frontal Pasajero	18A	18CA	45EC		
Duster							
2016-13		Frontal	20A	20CA	50EC	5050EC	
Encore							
1986-85		Frontal		18CA	45EC	4545EC	
Kangoo							
2009-07		Frontal Conductor	20A	20CA	50EC		
		Frontal Pasajero	18A	18CA	45EC		
Kangoo Express							
2016-10		Frontal Conductor	22A	22CA	55EC		
		Frontal Pasajero	21A	21CA	53EC		
2009-04		Frontal Conductor	20A	20CA	50EC		
		Frontal Pasajero	18A	18CA	45EC		
Koleos							
2019-18		Frontal Conductor	22A	22CA	55EC		
		Frontal Pasajero	16A	16CA	40EC		
		Trasera					H230
2017-09		Frontal Conductor	24OE	24CA			
		Frontal Pasajero	19OE	19CA			
Laguna							
2006-03		Frontal Conductor	24A	24CA	60EC		
		Frontal Pasajero	20A	20CA	50EC		
Logan							
2017-15		Frontal Conductor	20A	20CA	50EC		
		Frontal Pasajero	18A	18CA	45EC		
Megane							
2006-03		Frontal Conductor	24A	24CA	60EC		
		Frontal Pasajero	18A	18CA	45EC		
2002-01		Frontal Conductor	22A	22CA	55EC		
		Frontal Pasajero	20A	20CA	50EC		
R5							
1984-79		Frontal	16A	16CA	40EC	4040EC	
R12							
1984-78		Frontal	16A	16CA	40EC	4040EC	
R18							
1986-80		Frontal	16A	16CA	40EC	4040EC	
Safrane							
2015-09		Frontal	24A	24CA	60EC	6060EC	

R

		Ubicación	Pluma Plana		Convencional		Traseras Especiales
			ICON	Clear Advantage	ECO	ECO Set	
Renault (cont'd.)							
Sandero							
2017-15	Frontal Conductor		20A	20CA	50EC		
	Frontal Pasajero		18A	18CA	45EC		
2013-10	Frontal Conductor		20A	20CA	50EC		
	Frontal Pasajero		18A	18CA	45EC		
Scenic							
2004-01	Frontal Conductor		24A	24CA	60EC		
	Frontal Pasajero		16A	16CA	40EC		
Stepway							
2016-10	Frontal Conductor		20A	20CA	50EC		
	Frontal Pasajero		18A	18CA	45EC		
Trafic							
2014-08	Frontal		20A	20CA	50EC	5050EC	
Rover							
75							
2005-03	Frontal Conductor		22A	22CA	55EC		
	Frontal Pasajero		21A	21CA	53EC		
2000	Frontal Conductor		22A	22CA	55EC		
	Frontal Pasajero		21A	21CA	53EC		
Saab							
9-3							
2009-08	Frontal		22OE	22CA			
2007-03	Frontal			22CA	55EC	5555EC	
	Frontal Conductor		22A				
2002-01	Frontal Pasajero		22B				
	Frontal		21A	21CA	53EC	5353EC	
Hatchback	Trasera				50EC		
9-5							
2006-01	Frontal			22CA	55EC	5555EC	
	Frontal Conductor		22A				
	Frontal Pasajero		22B				
Seat							
Alhambra							
2008-02	Frontal		28AOE	28CA			
Arona							
2019-18	Frontal Conductor		26OE	26CA			
	Frontal Pasajero		18OE	18CA			
Ateca							
2018-17	Frontal Conductor		26OE	26CA			
	Frontal Pasajero		18OE	18CA			
	Trasera						A282H
Cordoba							
2009-07	Frontal Conductor		21OE	21CA			
	Frontal Pasajero		19OE	19CA			
2006-03	Frontal Conductor		21A	21CA	53EC		
	Frontal Pasajero		18A	18CA	45EC		
2002-01	Frontal					5347EC	
	Frontal Conductor		21A	21CA	53EC		
	Frontal Pasajero		19A	19CA	48EC		
Ibiza							
2019-17	Frontal Conductor		26OE	26CA			
	Frontal Pasajero		17OE				
2016-10	Frontal Conductor		24OE	24CA			
	Frontal Pasajero		15OE	16CA			
2009-07	Frontal Conductor		21OE	21CA			
	Frontal Pasajero		19OE	19CA			
2006-02	Frontal Conductor		21A	21CA	53EC		
	Frontal Pasajero		18A	18CA	45EC		
2001	Frontal					5347EC	
	Frontal Conductor		21A	21CA	53EC		
	Frontal Pasajero		19A	19CA	48EC		
Leon							
2019-16	Frontal Conductor		26OE	26CA			
	Frontal Pasajero			18CA			
2015-14	Frontal Conductor		26OE	26CA			
	Frontal Pasajero		15OE				
2013-05	Frontal		26OE	26CA			
2004-01	Frontal					5347EC	
	Frontal Conductor		21A	21CA	53EC		
	Frontal Pasajero		19A	19CA	48EC		



			Pluma Plana		Convencional		Traseras Especiales
			ICON	Clear Advantage	ECO	ECO Set	
Ubicación							
Seat (cont'd.)							
Nuevo Ibiza							
2010		Frontal Conductor	24OE	24CA			
		Frontal Pasajero	15OE	16CA			
Toledo							
2019-16		Frontal	24OE	24CA			
2015		Frontal Conductor	24OE	24CA			
		Frontal Pasajero	15OE	16CA			
2013		Frontal Conductor	24OE	24CA			
		Frontal Pasajero	15OE	16CA			
2004-01		Frontal Conductor	21A	21CA	53EC		
		Frontal Pasajero	18A	18CA	45EC		
Smart							
Cabrio							
2005-04		Frontal	21A	21CA	53EC	5353EC	
City-Coupe							
2004-03		Frontal	21A	21CA	53EC	5353EC	
Crossblade							
2004		Frontal Conductor	24A	24CA	60EC		
		Frontal Pasajero	22B	22CA	55EC		
Forfour							
2007-05		Frontal Conductor	26A	26CA	65EC		
		Frontal Pasajero	18A	18CA	45EC		
Fortwo							
2018	Coupe	Trasera					H180
2017-16		Trasera					H180
2015	Convertible	Frontal Conductor	22OE	22CA			
		Frontal Pasajero	21OE	21CA			
	Coupe	Trasera					H180
2014	Convertible	Frontal Conductor	22OE	22CA			
		Frontal Pasajero	21OE	21CA			
	Coupe	Frontal Conductor	24OE	24CA			
		Frontal Pasajero	22OE	22CA			
2013-07		Frontal Conductor	24OE	24CA			
		Frontal Pasajero	22OE	22CA			
2006-05		Frontal Conductor	24A	24CA	60EC		
		Frontal Pasajero	22B	22CA	55EC		
Roadster							
2004		Frontal Conductor	20A	20CA	50EC		
		Frontal Pasajero	18A	18CA	45EC		
SsangYong							
Rexton							
2005		Frontal	20A	20CA	50EC	5050EC	
Subaru							
B9 Tribeca							
2007-06		Frontal Pasajero	20B	20CA	50EC		
		Trasera					H354
BRZ							
2020-19		Frontal Conductor	22B	22CA	55EC		
		Frontal Pasajero	20B	20CA	50EC		
2017-16		Frontal Conductor	22B	22CA	55EC		
		Frontal Pasajero	20B	20CA	50EC		
Forester							
2018-14		Frontal Conductor	26A	26CA	65EC		
		Frontal Pasajero	17B	17CA	42EC		
		Trasera					H354
2012-09		Frontal Conductor	24A	24CA	60EC		
		Frontal Pasajero	18B	18CA	45EC		
		Trasera					H354
2008-07		Frontal Conductor	22A	22CA	55EC		
		Frontal Pasajero	19B	19CA	48EC		
		Trasera					H354
Impreza							
2017	Hatchback	Trasera					H306
2016-14		Frontal Pasajero	16A	16CA	40EC		
	Hatchback	Frontal Conductor	24A	24CA	60EC		
		Trasera					H306
	Sedan	Frontal Conductor	26A	26CA	65EC		
2013		Frontal Conductor	26A	26CA	65EC		
		Frontal Pasajero	16A	16CA	40EC		



		Ubicación	Pluma Plana		Convencional		Traseras Especiales
			ICON	Clear Advantage	ECO	ECO Set	
Subaru (cont'd.)							
Impreza (cont'd.)							
2012		Frontal Conductor	26A	26CA	65EC		
		Frontal Pasajero	16A	16CA	40EC		
	Hatchback	Trasera					H410
2011-08		Frontal Pasajero	16A	16CA	40EC		
	Hatchback	Frontal Conductor	26A	26CA	65EC		
		Trasera					H410
2007	Sedan	Frontal Conductor	24A	24CA	60EC		
		Frontal Conductor	22A	22CA	55EC		
		Frontal Pasajero	17B	17CA	42EC		
Legacy							
2015		Frontal Conductor	26A	26CA	65EC		
		Frontal Pasajero	17B	17CA	42EC		
2014-10		Frontal Conductor	26A	26CA	65EC		
		Frontal Pasajero	19B	19CA	48EC		
2009-06		Frontal Conductor	24A	24CA	60EC		
		Frontal Pasajero	18B	18CA	45EC		
Outback							
2017		Frontal Conductor	26A	26CA	65EC		
		Frontal Pasajero	17B	17CA	42EC		
		Trasera					H354
2015		Frontal Conductor	26A	26CA	65EC		
		Frontal Pasajero	17B	17CA	42EC		
		Trasera					H354
2014-10		Frontal Conductor	26A	26CA	65EC		
		Frontal Pasajero	19B	19CA	48EC		
		Trasera					H354
2008-06		Frontal Conductor	24A	24CA	60EC		
		Frontal Pasajero	18B	18CA	45EC		
		Trasera					H354
Tribeca							
2012-08		Frontal Pasajero	20B	20CA	50EC		
		Trasera					H354
WRX							
2018-15		Frontal Conductor	26A	26CA	65EC		
		Frontal Pasajero	16A	16CA	40EC		
2014	Hatchback	Frontal Pasajero	16A	16CA	40EC		
		Frontal Conductor	24A	24CA	60EC		
		Trasera					H306
2013	Sedan	Frontal Conductor	26A	26CA	65EC		
		Frontal Conductor	26A	26CA	65EC		
		Frontal Pasajero	16A	16CA	40EC		
2012	Hatchback	Trasera					H410
		Frontal Pasajero	16A	16CA	40EC		
		Trasera					H410
	Sedan	Frontal Conductor	24A	24CA	60EC		
WRX STI							
2018-17		Frontal Conductor	26A	26CA	65EC		
		Frontal Pasajero	16A	16CA	40EC		
XV							
2016-13		Frontal Conductor	26A	26CA	65EC		
		Frontal Pasajero	16A	16CA	40EC		
		Trasera					H306
Suzuki							
Aerio							
2007-06		Frontal Conductor	22A	22CA	55EC		
		Frontal Pasajero	18B	18CA	45EC		
Ciaz							
2017-16		Frontal Conductor	24A	24CA	60EC		
		Frontal Pasajero	16A	16CA	40EC		
Grand Vitara							
2017-14		Frontal	19A	19CA	48EC	4747EC	
2013-07		Frontal		19CA	48EC	4747EC	
		Frontal Conductor	19A				
		Frontal Pasajero	19B				
		Trasera					H307
Ignis							
2017		Frontal				5347EC	
		Frontal Conductor	21A	21CA	53EC		
		Frontal Pasajero	19A	19CA	48EC		



		Ubicación	Pluma Plana		Convencional		Traseras Especiales
			ICON	Clear Advantage	ECO	ECO Set	
Suzuki (cont'd.)							
Kizashi							
2016-15	Frontal Conductor	24A	24CA	60EC			
	Frontal Pasajero	20A	20CA	50EC			
2013-10	Frontal Conductor	24A	24CA	60EC			
	Frontal Pasajero	20B	20CA	50EC			
S-Cross							
2017-14	Frontal Conductor	26A	26CA	65EC			
	Frontal Pasajero	13A	13CA	34EC			
Swift							
2017-07	Frontal Conductor	21A	21CA	53EC			
	Frontal Pasajero	18A	18CA	45EC			
SX4							
2014	Frontal Conductor	26A	26CA	65EC			
	Frontal Pasajero	13A	13CA	34EC			
2013-10	Frontal Conductor	26A	26CA	65EC			
	Frontal Pasajero	13A	13CA	34EC			
2009-08	Hatchback						H250
	Trasera						
2009-08	Frontal Conductor	26A	26CA	65EC			
	Frontal Pasajero	13A	13CA	34EC			
Vitara							
2017-16	Frontal	19A	19CA	48EC	4747EC		
XL-7							
2007	Frontal Conductor	24A	24CA	60EC			
	Frontal Pasajero	19A	19CA	48EC			
	Trasera			34EC			
Toyota							
4Runner							
2008-03	Frontal Conductor	22A	22CA	55EC			
	Frontal Pasajero	20A	20CA	50EC			
	Trasera						H307F
Avanza							
2018-07	Frontal Conductor	20A	20CA	50EC			
	Frontal Pasajero	16A	16CA	40EC			
Camry							
2019-18	Frontal Conductor	26A	26CA	65EC			
	Frontal Pasajero	20A	20CA	50EC			
2017-12	Frontal Conductor	26A	26CA	65EC			
	Frontal Pasajero	18A	18CA	45EC			
2011-07	Frontal Conductor	24A	24CA	60EC			
	Frontal Pasajero	20A	20CA	50EC			
2006-02	Frontal Conductor	24A	24CA	60EC			
	Frontal Pasajero	19A	19CA	48EC			
Corolla							
2019-09	Frontal Conductor	26A	26CA	65EC			
	Frontal Pasajero	16A	16CA	40EC			
2008-03	Frontal Conductor	24A	24CA	60EC			
	Frontal Pasajero	18A	18CA	45EC			
FJ Cruiser							
2014-08	Frontal Conductor	16A	16CA	40EC			
	Frontal Pasajero	13A	13CA	34EC			
	Centro	13A	13CA	34EC			
Hiace							
2017-06	Frontal	21A	21CA	53EC	5353EC		
Highlander							
2019-08	Frontal Conductor	26A	26CA	65EC			
	Frontal Pasajero	20B	20CA	50EC			
	Trasera						H307
Hilux							
2017-15	Frontal Conductor	22A	22CA	55EC			
	Frontal Pasajero	16A	16CA	40EC			
2014-04	Frontal				5347EC		
	Frontal Conductor	21A	21CA	53EC			
	Frontal Pasajero	19A	19CA	48EC			
Land Cruiser							
2018-14	Frontal Conductor	24A	24CA	60EC			
	Frontal Pasajero	22B	22CA	55EC			
	Trasera						H309
2013	Frontal Conductor	24A	24CA	60EC			
	Frontal Pasajero	22A	22CA	55EC			
	Trasera						H309

**S
T**

		Ubicación	Pluma Plana		Convencional		Traseras Especiales
			ICON	Clear Advantage	ECO	ECO Set	
Toyota (cont'd.)							
Land Cruiser (cont'd.)							
2011-08		Frontal Conductor	24A	24CA	60EC		
		Frontal Pasajero	22A	22CA	55EC		
		Trasera					H309
2007		Frontal Conductor	24A	24CA	60EC		
		Frontal Pasajero	22B	22CA	55EC		
2006-04		Frontal Conductor	24A	24CA	60EC		
		Frontal Pasajero	22B	22CA	55EC		
		Trasera			40EC		
Matrix							
2009		Frontal Conductor	26A	26CA	65EC		
		Frontal Pasajero	17A	17CA	42EC		
		Trasera					H307
MR2 Spyder							
2006		Frontal Conductor	20A	20CA	50EC		
		Frontal Pasajero	19A	19CA	48EC		
2005		Frontal Conductor	20A	20CA	50EC		
		Frontal Pasajero	19B	19CA	48EC		
Prius							
2017-16		Trasera					H409
2015-12		Frontal Conductor	26A	26CA	65EC		
		Frontal Pasajero	19B	19CA	48EC		
		Trasera					H409
Prius C							
2019-18		Frontal Conductor	28A	28CA	70EC		
		Frontal Pasajero	13A	13CA	34EC		
		Trasera					H200
RAV4							
2018-13		Frontal Conductor	26A	26CA	65EC		
		Frontal Pasajero	16A	16CA	40EC		
		Trasera					H252
2012-06		Frontal Conductor	24A	24CA	60EC		
		Frontal Pasajero	17B	17CA	42EC		
		Trasera					H309
2005-04		Frontal Conductor	22A	22CA	55EC		
		Frontal Pasajero	19B	19CA	48EC		
		Trasera					H309
Sequoia							
2018-08		Frontal Conductor	26OE	26CA			
		Frontal Pasajero	22OE	22CA			
Sienna							
2019-11		Frontal Conductor	28A	28CA	70EC		
		Frontal Pasajero	20B	20CA	50EC		
		Trasera					H409
2010-06		Frontal Conductor	26A	26CA	65EC		
		Frontal Pasajero	19A	19CA	48EC		
		Trasera			40EC		
2005-04		Frontal Conductor	26A	26CA	65EC		
		Frontal Pasajero	19A	19CA	48EC		
		Trasera					H409
2003		Frontal Conductor	24A	24CA	60EC		
		Frontal Pasajero	18B	18CA	45EC		
		Trasera			42EC		
Solara							
2006-05		Frontal Conductor	24A	24CA	60EC		
	Convertible	Frontal Pasajero	19B	19CA	48EC		
	Coupe	Frontal Pasajero	19A	19CA	48EC		
Tacoma							
2018-16		Frontal Conductor	22A	22CA	55EC		
		Frontal Pasajero	20B	20CA	50EC		
2015-06		Frontal Conductor	22A	22CA	55EC		
		Frontal Pasajero	21B	21CA	53EC		
Tundra							
2019-07		Frontal Conductor	26OE	26CA			
		Frontal Pasajero	22OE	22CA			
Yaris							
2020-19	Sedan	Frontal Conductor	22A	22CA	55EC		
		Frontal Pasajero	17A	17CA	42EC		
2018	Sedan	Frontal Conductor	24A	24CA	60EC		
		Frontal Pasajero	13A	13CA	34EC		

T

				Pluma Plana		Convencional		
		Ubicación		ICON	Clear Advantage	ECO	ECO Set	Traseras Especiales
Toyota (cont'd.)								
Yaris (cont'd.)								
2017-16	Hatchback	Trasera				70EC		H309
		Centro				60EC		
	Sedan	Frontal Conductor	24A	24CA		34EC		
		Frontal Pasajero	13A	13CA				
2015-13	Hatchback	Trasera						H309
	Sedan	Centro	28A	28CA		70EC		
2012	Hatchback	Trasera						H309
		Centro				70EC		
	Sedan	Frontal Conductor	26A	26CA		65EC		
		Frontal Pasajero	13A	13CA		34EC		
2011-07		Frontal Conductor	26A	26CA		65EC		
		Frontal Pasajero	13A	13CA		34EC		
	Hatchback	Trasera						H309
2006		Frontal Conductor	26A	26CA		65EC		
		Frontal Pasajero	13A	13CA		34EC		
		Trasera						H309
2005-04	Hatchback	Frontal Conductor	21A	21CA		53EC		
		Frontal Pasajero	15A	15CA		38EC		
Volkswagen								
Amarok								
2019-13		Frontal	24OE	24CA				
2012-11		Frontal Conductor	24A	24CA		60EC		
		Frontal Pasajero	21A	21CA		53EC		
Atlantic								
1987-81		Frontal	16A	16CA		40EC	4040EC	
Beetle								
2019-12		Frontal	21OE	22CA				
2011		Frontal	21OE					
2010-01		Frontal		21CA		53EC	5353EC	
		Frontal Conductor	21A					
		Frontal Pasajero	21B					
2000-98		Frontal	21A	21CA		53EC	5353EC	
Beetle Cabrio								
2011		Frontal	21OE					
2010		Frontal		21CA		53EC	5353EC	
		Frontal Conductor	21A					
		Frontal Pasajero	21B					
Bora								
2010		Frontal Conductor	24OE	24CA				
		Frontal Pasajero	19OE	19CA				
2009		Frontal Conductor	24OE	24CA				
		Frontal Pasajero	19OE	19CA				
	Wagon	Trasera						A330H
2008-06		Frontal Conductor	24OE	24CA				
		Frontal Pasajero	19OE	19CA				
Brasilia								
1982-75		Frontal	18A	18CA		45EC	4545EC	
Cabrio								
2002-96		Frontal					5347EC	
		Frontal Conductor	21A	21CA		53EC		
		Frontal Pasajero	19B	19CA		48EC		
Caddy								
2019-14		Frontal Conductor	24OE	24CA				
		Frontal Pasajero	18OE	18CA				
Caribe								
1987-77		Frontal	16A	16CA		40EC	4040EC	
CC								
2017-13		Frontal Conductor	24OE	24CA				
		Frontal Pasajero	19OE	19CA				
Clasico								
2015-14		Frontal Conductor	24OE	24CA				
		Frontal Pasajero	19OE	19CA				
2013-11		Frontal					5347EC	
		Frontal Conductor	21A	21CA		53EC		
		Frontal Pasajero	19A	19CA		48EC		
Combi								
2001-94		Frontal	16A	16CA		40EC	4040EC	
1993-92		Frontal	21A	21CA		53EC	5353EC	
1991-74		Frontal	16A	16CA		40EC	4040EC	



		Ubicación	Pluma Plana		Convencional		Traseras Especiales
			ICON	Clear Advantage	ECO	ECO Set	
Volkswagen (cont'd.)							
Corsar							
1988-85		Frontal	18A	18CA	45EC	4545EC	
Crafter							
2018-17		Frontal Conductor	28AOE				
		Frontal Pasajero	26OE	26CA			
2016		Frontal Conductor	26OE	26CA			
		Frontal Pasajero	24OE	24CA			
Crafter Van							
2019-17		Frontal Conductor	28AOE				
		Frontal Pasajero	26OE	26CA			
2016-08		Frontal Conductor	26OE	26CA			
		Frontal Pasajero	24OE	24CA			
CrossFox							
2017-11		Frontal Conductor	24OE	24CA			
		Frontal Pasajero	19OE	19CA			
2009-07		Frontal Conductor	24OE	24CA			
		Frontal Pasajero	19OE	19CA			
Derby							
2009-05		Frontal	18A	18CA	45EC	4545EC	
2004-98		Frontal Conductor	21A	21CA	53EC		
		Frontal Pasajero	18A	18CA	45EC		
1997-95		Frontal	18A	18CA	45EC	4545EC	
Eos							
2010		Frontal Conductor	24OE	24CA			
		Frontal Pasajero	19OE	19CA			
EuroVan							
2009-06		Frontal	24OE	24CA			
2004		Frontal	24OE	24CA			
2003-00		Frontal Conductor	21A	21CA	53EC		
		Frontal Pasajero	20A	20CA	50EC		
Gol							
2020-19		Frontal Conductor	21OE	22CA			
		Frontal Pasajero	15OE				
2018-17	Hatchback	Frontal Conductor	21OE	22CA			
		Frontal Pasajero	15OE				
	Sedan	Frontal	18A	18CA	45EC	4545EC	
2016		Frontal	18A	18CA	45EC	4545EC	
2013-12		Frontal Conductor	22A	22CA	55EC		
		Frontal Pasajero	16A	16CA	40EC		
2011-09		Frontal	18A	18CA	45EC	4545EC	
Golf							
2019-16		Frontal Conductor	26OE	26CA			
		Frontal Pasajero	18OE	18CA			
		Trasera					A282H
2013		Frontal Conductor	24OE	24CA			
		Frontal Pasajero	19OE	19CA			
		Trasera					A330H
2007		Frontal				5347EC	
		Frontal Conductor	21A	21CA	53EC		
		Frontal Pasajero	19B	19CA	48EC		
2006-93		Frontal				5347EC	
		Frontal Conductor	21A	21CA	53EC		
		Frontal Pasajero	19B	19CA	48EC		
1992-87		Trasera			34EC		
		Frontal	16A	16CA	40EC	4040EC	
		Trasera			40EC		
Golf R							
2019-18		Frontal Conductor	26OE	26CA			
		Frontal Pasajero	18OE	18CA			
		Trasera					A282H
Golf SportWagen							
2013		Frontal Conductor	26OE	26CA			
		Frontal Pasajero	18OE	18CA			
		Trasera					A330H
2012		Frontal Conductor	22A	22CA	55EC		
		Frontal Pasajero	16A	16CA	40EC		
		Trasera					A330H
2011		Frontal	18A	18CA	45EC	4545EC	
		Trasera					A330H
2010		Frontal Conductor	22A	22CA	55EC		
		Frontal Pasajero	18A	18CA	45EC		



		Ubicación	Pluma Plana		Convencional		Traseras Especiales
			ICON	Clear Advantage	ECO	ECO Set	
Volkswagen (cont'd.)							
Gol Sedan							
2013		Frontal	18A	18CA	45EC	4545EC	
2012-11		Frontal Conductor	22A	22CA	55EC		
		Frontal Pasajero	16A	16CA	40EC		
2010		Frontal Conductor	22A	22CA	55EC		
		Frontal Pasajero	18A	18CA	45EC		
GTI							
2018		Frontal Conductor	26OE	26CA			
		Frontal Pasajero	18OE	18CA			
		Trasera					A282H
2017-15		Frontal Conductor	26OE	26CA			
		Frontal Pasajero	18OE	18CA			
		Trasera					A330H
2013		Frontal Conductor	26OE	26CA			
		Frontal Pasajero	18OE	18CA			
		Trasera					A330H
2012-11		Frontal Conductor	24OE	24CA			
		Frontal Pasajero	19OE	19CA			
		Trasera					A330H
2010		Frontal Conductor	24OE	24CA			
		Frontal Pasajero	19OE	19CA			
		Trasera					A282H
2009-07		Frontal Conductor	24OE	24CA			
		Frontal Pasajero	19OE	19CA			
		Trasera					A330H
Jetta							
2019-07		Frontal Conductor	24OE	24CA			
		Frontal Pasajero	19OE	19CA			
2006	Sedan	Frontal Conductor	24OE	24CA			
		Frontal Pasajero	19OE	19CA			
2005		Frontal Conductor	24OE	24CA			
		Frontal Pasajero	19OE	19CA			
2004		Frontal				5347EC	
		Frontal Conductor	21A	21CA	53EC		
		Frontal Pasajero	19B	19CA	48EC		
2003-01		Frontal				5347EC	
		Frontal Conductor	21A	21CA	53EC		
		Frontal Pasajero	19B	19CA	48EC		
2000-93	Wagon	Trasera			38EC		
		Frontal				5347EC	
		Frontal Conductor	21A	21CA	53EC		
1992-87		Frontal Pasajero	19B	19CA	48EC		
		Frontal	16A	16CA	40EC	4040EC	
		Frontal	16A	16CA	40EC	4040EC	
Jetta City							
2009-08		Frontal Conductor	24A	24CA	60EC		
		Frontal Pasajero	19A	19CA	48EC		
Lupo							
2009-05		Frontal				5347EC	
		Frontal Conductor	21A	21CA	53EC		
		Frontal Pasajero	19A	19CA	48EC		
Nuevo Gol							
2016-14		Frontal Conductor	21OE	22CA			
		Frontal Pasajero		16CA			
Panel							
2001-95		Frontal	16A	16CA	40EC	4040EC	
Passat							
2018-12		Frontal Conductor	24OE	24CA			
		Frontal Pasajero	19OE	19CA			
2010-08		Frontal Conductor	24OE	24CA			
		Frontal Pasajero	19OE	19CA			
2005-03		Frontal Conductor	21OE	21CA			
		Frontal Pasajero	19OE	19CA			
2002		Frontal				5347EC	
		Frontal Conductor	21A	21CA	53EC		
		Frontal Pasajero	19B	19CA	48EC		
2001		Frontal		21CA	53EC	5353EC	
		Frontal Conductor	21A				
2000-99		Frontal Pasajero	21B				
		Frontal	21A	21CA	53EC	5353EC	
1997-96		Frontal	21A	21CA	53EC	5353EC	
1993		Frontal	21A	21CA	53EC	5353EC	

V

		Ubicación	Pluma Plana		Convencional		Traseras Especiales
			ICON	Clear Advantage	ECO	ECO Set	
Volkswagen (cont'd.)							
Passat (cont'd.)							
1992-91		Frontal	21A	21CA	53EC	5353EC	
	Wagon	Trasera			40EC		
Passat CC							
2012-10		Frontal Conductor	24OE	24CA			
		Frontal Pasajero	19OE	19CA			
Pointer							
2009-06		Frontal Conductor	21A	21CA	53EC		
		Frontal Pasajero	16A	16CA	40EC		
2005-03		Frontal Conductor	21A	21CA	53EC		
	Hatchback	Frontal Pasajero	16A	16CA	40EC		
	Wagon	Frontal				5347EC	
		Frontal Pasajero	19A	19CA	48EC		
2002-98		Frontal				5347EC	
		Frontal Conductor	21A	21CA	53EC		
		Frontal Pasajero	19A	19CA	48EC		
Pointer Truck							
2007-00		Frontal				5347EC	
		Frontal Conductor	21A	21CA	53EC		
		Frontal Pasajero	19A	19CA	48EC		
1999		Frontal Conductor	20A	20CA	50EC		
		Frontal Pasajero	19A	19CA	48EC		
Polo							
2020		Frontal Conductor	26OE	26CA			
		Frontal Pasajero	18OE	18CA			
2019-18		Frontal Conductor	26OE	26CA			
		Frontal Pasajero	18OE	18CA			
		Trasera					A282H
2017		Frontal Conductor	24OE	24CA			
		Frontal Pasajero		16CA			
		Trasera					A282H
2016-13		Frontal Conductor	24OE	24CA			
		Frontal Pasajero		16CA			
2007		Frontal Conductor	21OE	21CA			
		Frontal Pasajero	18OE	18CA			
2006-03		Frontal				5347EC	
		Frontal Conductor	21A	21CA	53EC		
		Frontal Pasajero	19A	19CA	48EC		
R32							
2003		Frontal				5347EC	
		Frontal Conductor	21A	21CA	53EC		
		Frontal Pasajero	19B	19CA	48EC		
		Trasera			34EC		
Routan							
2012-09		Frontal Conductor	26A	26CA	65EC		
		Frontal Pasajero	20A	20CA	50EC		
		Trasera			40EC		
Safari							
1980-75		Frontal	16A	16CA	40EC	4040EC	
Saveiro							
2017		Frontal Conductor	22A	22CA	55EC		
		Frontal Pasajero	16A	16CA	40EC		
2016		Frontal				5347EC	
		Frontal Conductor	21A	21CA	53EC		
		Frontal Pasajero	19A	19CA	48EC		
2015	Pickup de tamaño estándar	Frontal				5347EC	
		Frontal Conductor	21A	21CA	53EC		
		Frontal Pasajero	19A	19CA	48EC		
2014-10		Frontal				5347EC	
		Frontal Conductor	21A	21CA	53EC		
		Frontal Pasajero	19A	19CA	48EC		
Sedan							
1990-03		Frontal					2828EC
Sharan							
2008-02		Frontal	28AOE	28CA			
Tiguan							
2020-16		Frontal Conductor	26OE	26CA			
		Frontal Pasajero	21OE	22CA			
		Trasera					A383H
2015-09		Frontal Conductor	24OE	24CA			
		Frontal Pasajero	21OE	21CA			
		Trasera					A330H

V

		Ubicación	Pluma Plana		Convencional		Traseras Especiales
			ICON	Clear Advantage	ECO	ECO Set	
Volkswagen (cont'd.)							
Touareg							
2018-15	Frontal		26OE	26CA			
	Trasera						A332H
2014-11	Frontal		26OE	26CA			
	Trasera						A360H
2009-08	Frontal		26OE	26CA			
	Trasera						A330H
2007-04	Frontal		26OE				
	Trasera						A330H
Transporter							
2018-10	Frontal		16A	16CA	40EC	4040EC	
Up!							
2017-16	Frontal Conductor		24OE	24CA			
	Frontal Pasajero			16CA			
Vento							
2018-14	Frontal Conductor		24OE	24CA			
	Frontal Pasajero			16CA			
Volvo							
C30							
2013	Frontal Conductor		26OE	26CA			
	Frontal Pasajero		20OE	20CA			
2012-11	Frontal Conductor		26OE	26CA			
	Frontal Pasajero		20OE	20CA			
2010-08	Trasera						H402
	Frontal Conductor		26OE	26CA			
	Frontal Pasajero		20OE	20CA			
	Trasera						A401H
C70							
2013-06	Frontal Conductor		26OE	26CA			
	Frontal Pasajero		19OE	19CA			
2004-99	Frontal		21A	21CA	53EC	5353EC	
S40							
2012-05	Frontal Conductor		26OE	26CA			
	Frontal Pasajero		20OE	20CA			
2004-00	Frontal			20CA	50EC	5050EC	
	Frontal Conductor		20A				
	Frontal Pasajero		20B				
1999	Frontal		20A	20CA	50EC	5050EC	
S60							
2018-11	Frontal Conductor		26OE	26CA			
	Frontal Pasajero		20OE	20CA			
2008-05	Frontal Conductor		24OE	24CA			
	Frontal Pasajero		21OE	21CA			
2004	Frontal Conductor			24CA			
	Frontal Conductor, To 07/2004		24A		60EC		
	Frontal Conductor, From 08/2004		24OE				
	Frontal Pasajero, From 08/2004		21OE	21CA			
2003	Frontal Pasajero, To 07/2004		22A	22CA	55EC		
	Frontal Conductor		24A	24CA	60EC		
2002-01	Frontal Pasajero		22B	22CA	55EC		
	Frontal Conductor		24A	24CA	60EC		
	Frontal Pasajero		22A	22CA	55EC		
S60 Cross Country							
2016	Frontal Conductor		26OE	26CA			
	Frontal Pasajero		20OE	20CA			
S70							
2000-99	Frontal		21A	21CA	53EC	5353EC	
S80							
2015-14	Frontal Conductor		26OE	26CA			
	Frontal Pasajero		20OE	20CA			
2011-08	Frontal Conductor		26OE	26CA			
	Frontal Pasajero		20OE	20CA			
2006-05	Frontal Conductor		24OE	24CA			
	Frontal Pasajero		21OE	21CA			
2004	Frontal Conductor		24OE	24CA			
	Frontal Pasajero		22OE	22CA			
2003	Frontal Conductor		24A	24CA	60EC		
	Frontal Pasajero		22B	22CA	55EC		



		Ubicación	Pluma Plana		Convencional		Traseras Especiales
			ICON	Clear Advantage	ECO	ECO Set	
Volvo (cont'd.)							
S80 (cont'd.)							
2002-01	Frontal Conductor	24A	24CA	60EC			
	Frontal Pasajero	22A	22CA	55EC			
2000	Frontal Conductor	24A	24CA	60EC			
	Frontal Pasajero	22B	22CA	55EC			
1999	Frontal Conductor	24A	24CA	60EC			
	Frontal Pasajero	22A	22CA	55EC			
S90							
2017	Frontal Conductor		24CA				
	Frontal Pasajero		20CA				
V40							
2019-14	Frontal Conductor	26OE	26CA				
	Frontal Pasajero	19OE	19CA				
2004	Frontal Conductor	26OE	26CA				
	Frontal Pasajero	20OE	20CA				
2003-00	Trasera			40EC			
	Frontal Conductor	21A	21CA	53EC			
	Frontal Pasajero	20B	20CA	50EC			
	Trasera			40EC			
1999	Frontal	20A	20CA	50EC	5050EC		
V40 Cross Country							
2018-17	Frontal Conductor	26OE	26CA				
	Frontal Pasajero	19OE	19CA				
	Trasera						A281H
2015-13	Frontal Conductor	26OE	26CA				
	Frontal Pasajero	19OE	19CA				
	Trasera						A281H
V50							
2007-05	Frontal Conductor	26OE	26CA				
	Frontal Pasajero	20OE	20CA				
	Trasera						H874
V60							
2016-15	Frontal Conductor	26OE	26CA				
	Frontal Pasajero	20OE	20CA				
	Trasera						H304
2014-13	Frontal Conductor	26OE	26CA				
	Frontal Pasajero	20OE	20CA				
V60 Cross Country							
2016	Frontal Conductor	26OE	26CA				
	Frontal Pasajero	20OE	20CA				
	Trasera						H304
V70							
2003-01	Frontal Conductor	24A	24CA	60EC			
	Frontal Pasajero	22B	22CA	55EC			
	Trasera			40EC			
2000-99	Frontal	21A	21CA	53EC	5353EC		
	Trasera			42EC			
XC60							
2019-18	Trasera						A330H
2017-12	Frontal Conductor	26OE	26CA				
	Frontal Pasajero	20OE	20CA				
	Trasera						H353
2011-10	Frontal Conductor	26OE	26CA				
	Frontal Pasajero	20OE	20CA				
	Trasera						A380H
XC70							
2007-05	Frontal Conductor	24OE	24CA				
	Frontal Pasajero	22OE	22CA				
	Trasera						H370
2004	Frontal Conductor	24A	24CA	60EC			
	Frontal Pasajero	22A	22CA	55EC			
	Trasera						H370
XC90							
2019-16	Frontal Conductor		24CA				
	Frontal Pasajero		20CA				
	Trasera						A351H
2014-13	Frontal Conductor	24OE	24CA				
	Frontal Pasajero	21OE	21CA				
	Trasera						H353
2012	Frontal Conductor	24OE	24CA				
	Frontal Pasajero	21OE	21CA				
	Trasera						A380H



	Ubicación	Pluma Plana		Convencional		Traseras Especiales
		ICON	Clear Advantage	ECO	ECO Set	
Volvo (cont'd.)						
XC90 (cont'd.)						
2010-07	Frontal Conductor	240E	24CA			
	Frontal Pasajero	210E	21CA			
	Trasera					A380H
2006-05	Frontal Conductor	240E	24CA			
	Frontal Pasajero	210E	21CA			
	Trasera					H370
2004-03	Frontal Conductor	24A	24CA	60EC		
	Frontal Pasajero	22B	22CA	55EC		
	Trasera					H370





CASA CENTRAL | MAR DEL PLATA

Av. Colon 5757 (CP 7600) | Tel: (223) 410.4000
ccentral@iturria.com.ar

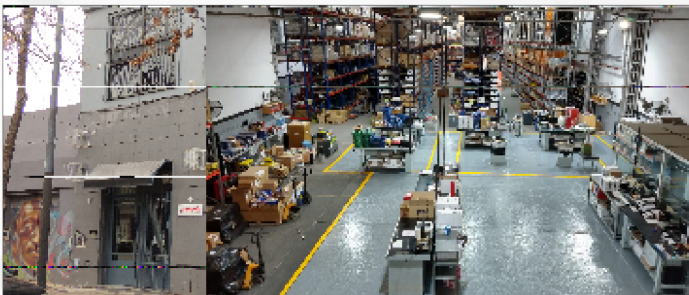

SUCURSAL CAPITAL FEDERAL

Andonaegui 1035 (C1427BEC) | Tel: (011) 3526.3020
sucursalcapital@iturria.com.ar



SUCURSAL BAHIA BLANCA

Av. Colon 1477 (B8000FUE) | Tel: (0291) 455.0333
sucursalbahia@iturria.com.ar

CATALOGO DIGITAL

Con solo un click ahora puedes hacer todas tus compras desde **catalogodigital.iturria.com.ar**

