

CATALOGO GENERAL DIESEL Y COMMON RAIL

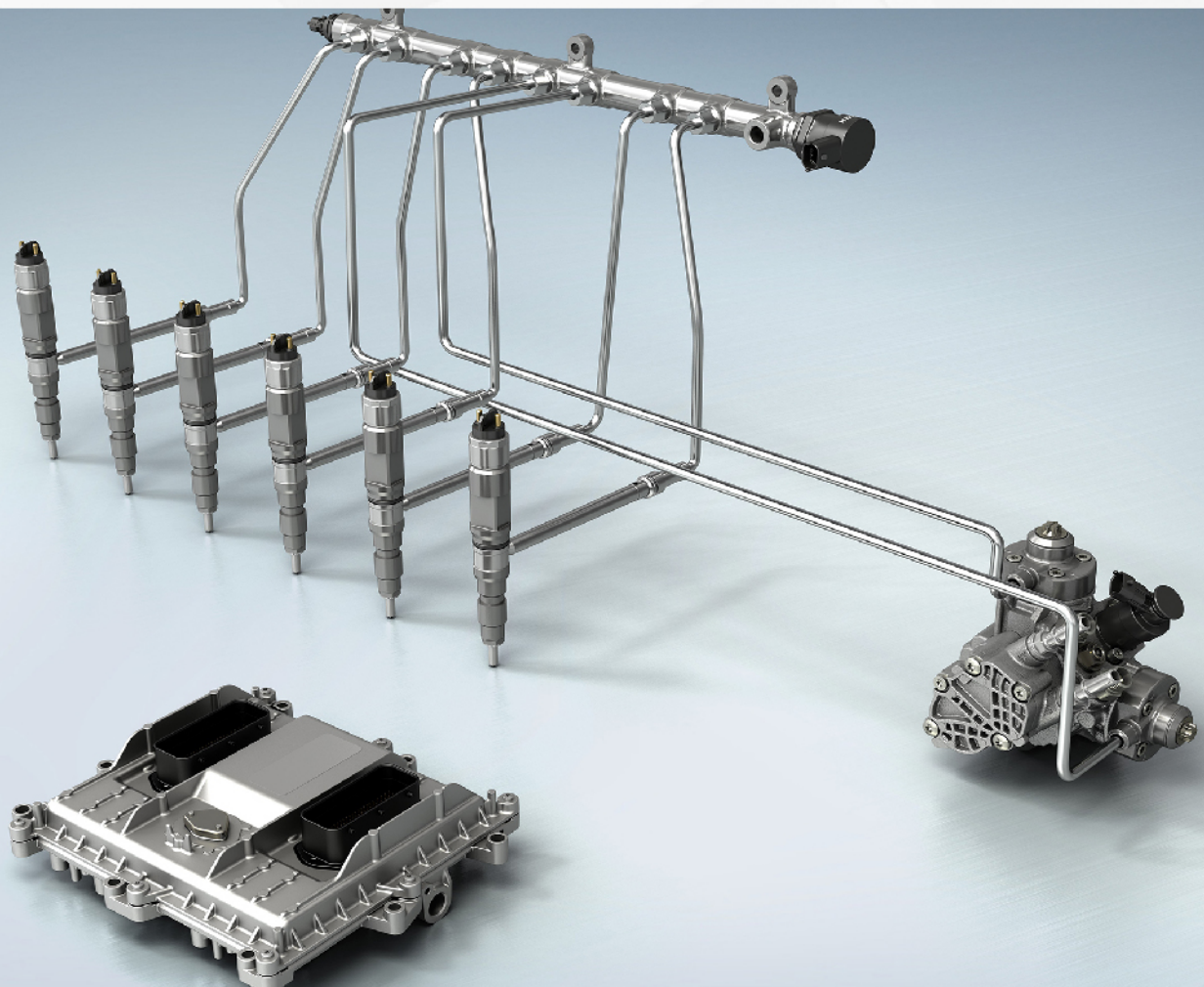

CATALOGO DE BATERIAS BOSCH



Principales componentes de las baterías Bosch. Ahora cuatro familias de productos y una sola tecnología.

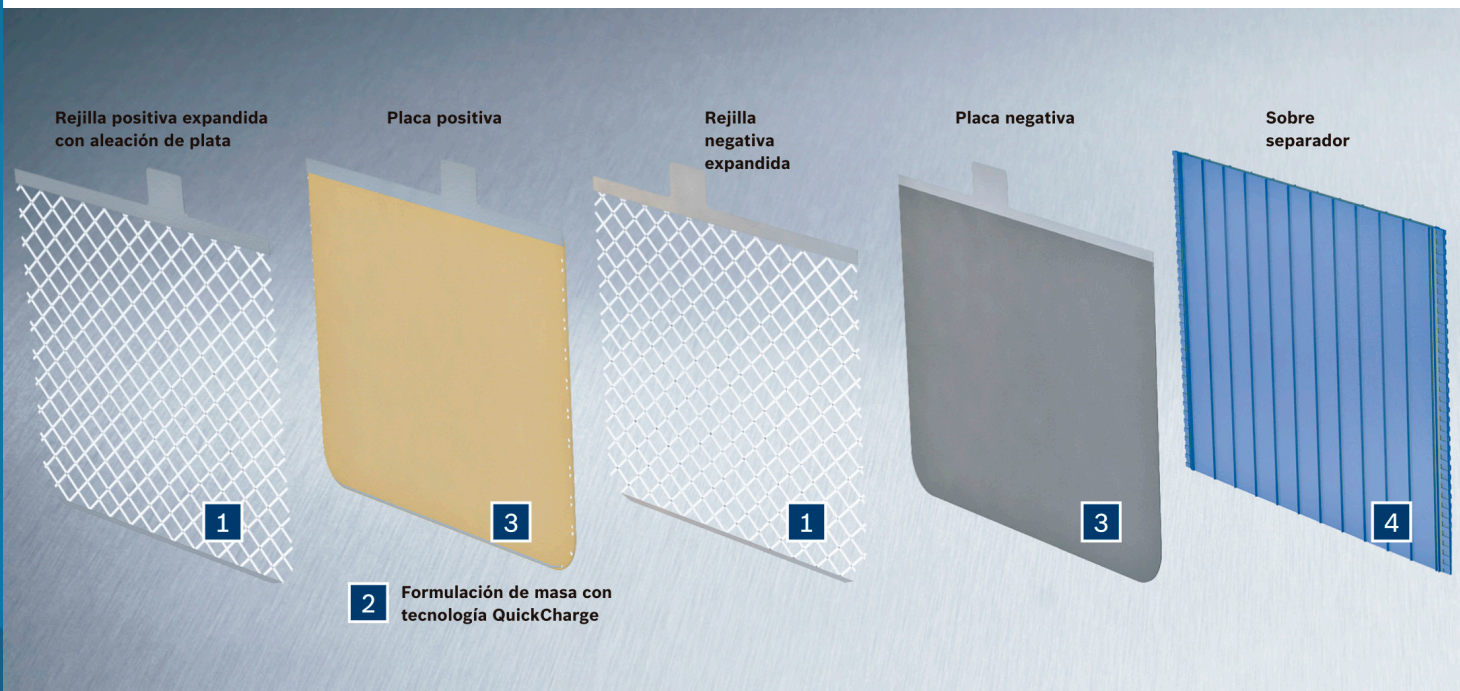

1 Rejillas

Sirven de soporte para la masa activa y tienen la función de conductor eléctrico.

Característica Bosch:

Rejilla expandida con plata

Estructura metalográfica perfeccionada, con cristales más finos.

Espesor progresivo, para optimizar el ancho de la rejilla y facilitar la conducción de la corriente eléctrica.

Mayor resistencia a la corrosión en altas temperaturas.

Mayor aceptación de la carga.

Libre de mantenimiento.

Mayor durabilidad.

2 Formulación de masa

Bosch utiliza en la formulación de masa la innovadora tecnología QuickCharge, que permite la rápida recarga de las baterías SilverStar, obteniendo el máximo rendimiento desde el inicio de la carga.

Con eso, no es necesario el aumento de la tensión del cargador para que la batería empiece el proceso de recarga.

3 Placas

Uno de los principales atributos son sus cantos redondeados y amarre balanceado.

Son los conjuntos formados por rejilla más masa activa. Las placas negativas y positivas se encuentran intercaladas en el bloque, separadas por un material aislante, para que una no toque la otra ocasionando un cortocircuito.

Característica Bosch:

Placas reforzadas

Rápida aceptación de la carga.

Mejor desempeño en recorridos de corta distancia.

Mayor volumen de ácido arriba de las placas (reserva de seguridad).

Placas con esquinas redondeadas evitan perforación del sobre.

Mejor comportamiento en cargas cíclicas (carga y descarga).

Característica Bosch:

Tecnología QuickCharge

Recargas más rápidas.

Menor temperatura de trabajo.

Mayor energía en los arranques.

Menor autodescarga.

Menor corrosión de la rejilla.

Mayor durabilidad.

4 Separadores

Son los componentes responsables de aislar las placas positivas de las placas negativas, impidiendo el cortocircuito.

Característica Bosch:

Sobres separadores microporosos de polietileno

Mejor aceptación de la corriente durante la carga.

Protección contra cortocircuito entre las placas.

Mayor potencia de arranque.

5 Bloque

Es el conjunto de placas positivas, negativas y separadores, interconectados por conexiones.

Característica Bosch:

Mayor durabilidad

Mayor aceptación de carga [+ 48%].

Mayor vida útil.

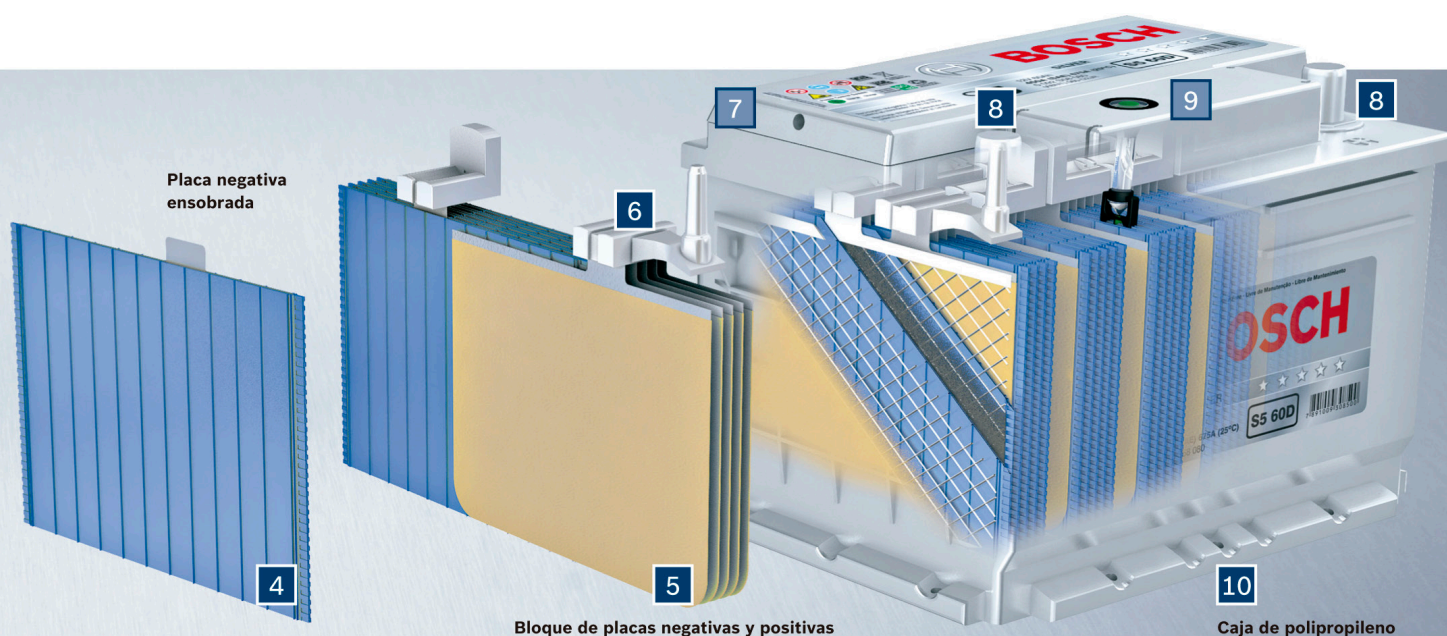

6 Conexión

Su función es interconectar las placas de misma polaridad dentro de un mismo bloque e interconectar cada bloque con su subsiguiente en serie.

Característica Bosch:

Conexiones (straps) centrales

La localización de los conectores evita un posible cortocircuito por un eventual desplazamiento de la placa opuesta, uno de los principales motivos de "muerte" de las baterías construidas con conexiones laterales.

7 Tapa

Tiene la función de mantener los vasos sellados, impidiendo la salida del electrólito al medio ambiente, además de evitar la entrada de materiales al interior de la batería.

Característica Bosch:

Tapa laberinto con tecnología SMSII

(para toda la línea liviana)

Laberinto para condensación y retorno de líquido a la batería.

Mayor durabilidad.

Mayor seguridad para vehículos con baterías en el habitáculo de los pasajeros.

8 Polos terminales

Son los terminales externos de la batería, donde están conectados los cables para alimentación del circuito eléctrico del vehículo.

Característica Bosch:

Polos forjados en frío

Los polos importados son forjados en frío, proceso que impide la formación de poros, lo que evita la formación de sulfatos.

9 Indicador de carga

Característica Bosch:

Power Control System

Indicador de carga con cambio de color, disponible en algunos modelos

10 Caja

Su función es acomodar el bloque de placas que va a constituir cada elemento de la batería.

Característica Bosch:

Caja robusta

Fabricada en polipropileno de alta resistencia.

39NS40ZLMF - 39NS40ZMF

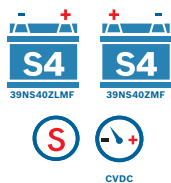

Amperaje (Ah)	35
CCA (SAE -18°C)	300
Medidas (largo/ancho/alto)	187x127x226 mm
Tipo	LIBRE MANTENCIÓN
Talón Inferior	Si
Polaridad	Positivo Derecho e Izquierdo
Borne	Delgado

39NS40LMF - 39NS40RMF



Amperaje (Ah)	40
CCA (SAE -18°C)	280
Medidas (largo/ancho/alto)	238x129x225 mm
Tipo	LIBRE MANTENCIÓN
Talón Inferior	No
Polaridad	Positivo Derecho e Izquierdo
Borne	Normal

39NS40ZLMFT



Amperaje (Ah)	40
CCA (SAE -18°C)	370
Medidas (largo/ancho/alto)	193x124x224 mm
Tipo	LIBRE MANTENCIÓN
Talón Inferior	Si
Polaridad	Positivo Derecho
Borne	Delgado, con buje adaptador

39NS60SLMF - 39NS60SMF

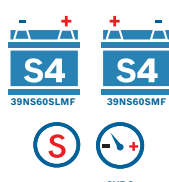

Amperaje (Ah)	42
CCA (SAE -18°C)	400
Medidas (largo/ancho/alto)	238x129x225 mm
Tipo	LIBRE MANTENCIÓN
Talón Inferior	No
Polaridad	Positivo Derecho e Izquierdo
Borne	Normal

39NS60LMF - 39NS60LMF



Amperaje (Ah)	42
CCA (SAE -18°C)	400
Medidas (largo/ancho/alto)	238x129x225 mm
Tipo	LIBRE MANTENCIÓN
Talón Inferior	No
Polaridad	Positivo Derecho e Izquierdo
Borne	Delgado

39S450DA-E - 39S450EA-E



Amperaje (Ah)	57
CCA (SAE -18°C)	440
Medidas (largo/ancho/alto)	238x129x225 mm
Tipo	LIBRE MANTENCIÓN
Talón Inferior	no
Polaridad	Positivo Derecho e Izquierdo
Borne	Delgado con buje adaptador

39S445D - 39S445E

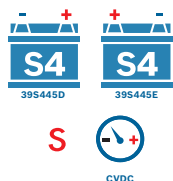

Amperaje (Ah)	45
CCA (SAE -18°C)	440
Medidas (largo/ancho/alto)	210x175x175 mm
Tipo	LIBRE MANTENCIÓN
Talón Inferior	Si
Polaridad	Positivo Derecho e Izquierdo
Borne	Normal

39S355D - 39S355E



Amperaje (Ah)	55
CCA (SAE -18°C)	370
Medidas (largo/ancho/alto)	244x175x175 mm
Tipo	LIBRE MANTENCIÓN
Talón Inferior	Si
Polaridad	Positivo Derecho e Izquierdo
Borne	Normal

39S455D-E - 39S455E-E



Amperaje (Ah)	55
CCA (SAE -18°C)	460
Medidas (largo/ancho/alto)	244x175x175 mm
Tipo	LIBRE MANTENCIÓN
Talón Inferior	Si
Polaridad	Positivo Derecho e Izquierdo
Borne	Normal

3975A72MF



Amperaje (Ah)	58
CCA (SAE -18°C)	615
Medidas (largo/ancho/alto)	231x179x185 mm
Tipo	LIBRE MANTENCIÓN
Talón Inferior	Si
Polaridad	Positivo Izquierdo
Borne	lateral

3955D23LMF - 3955D23RMF

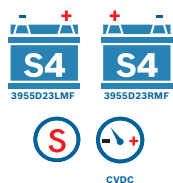

Amperaje (Ah)	60
CCA (SAE -18°C)	500
Medidas (largo/ancho/alto)	232x173x222 mm
Tipo	LIBRE MANTENCIÓN
Talón Inferior	Si
Polaridad	Positivo Derecho e Izquierdo
Borne	Normal

39N50ZLMF - 39N50ZMF



Amperaje (Ah)	60
CCA (SAE -18°C)	500
Medidas (largo/ancho/alto)	260x173x222 mm
Tipo	LIBRE MANTENCIÓN
Talón Inferior	Si
Polaridad	Positivo Derecho e Izquierdo
Borne	Normal

39S560D-E - 39S560E-E

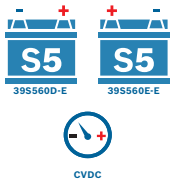

Amperaje (Ah)	60
CCA (SAE -18°C)	500
Medidas (largo/ancho/alto)	244x175x175 mm
Tipo	LIBRE MANTENCIÓN
Talón Inferior	Si
Polaridad	Positivo Derecho e Izquierdo
Borne	Normal

39N70MF - 39N70LMF

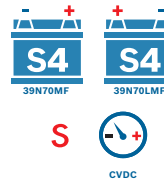

Amperaje (Ah)	65
CCA (SAE -18°C)	560
Medidas (largo/ancho/alto)	303x173x225 mm
Tipo	LIBRE MANTENCIÓN
Talón Inferior	No
Polaridad	Positivo Derecho e Izquierdo
Borne	Normal

39S665D - 39S665E

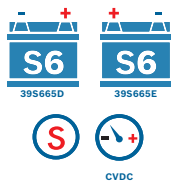

Amperaje (Ah)	65
CCA (SAE -18°C)	530
Medidas (largo/ancho/alto)	244x175x175 mm
Tipo	LIBRE MANTENCIÓN
Talón Inferior	Si
Polaridad	Positivo Derecho e Izquierdo
Borne	Normal

39S6638MF



Amperaje (Ah)	66
CCA (SAE -18°C)	570
Medidas (largo/ancho/alto)	278x175x190 mm
Tipo	LIBRE MANTENCIÓN
Talón Inferior	Si
Polaridad	Positivo Derecho
Borne	Lateral

3975D23LMF - 3975D23RMF

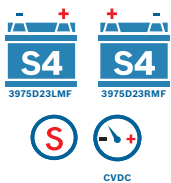

Amperaje (Ah)	70
CCA (SAE -18°C)	580
Medidas (largo/ancho/alto)	232x173x225 mm
Tipo	LIBRE MANTENCIÓN
Talón Inferior	Si
Polaridad	Positivo Derecho e Izquierdo
Borne	Normal

39NX110-5LMF - 39NX110-5MF

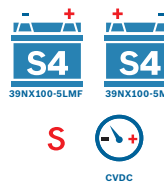

Amperaje (Ah)	70
CCA (SAE -18°C)	600
Medidas (largo/ancho/alto)	260x173x222 mm
Tipo	LIBRE MANTENCIÓN
Talón Inferior	Si
Polaridad	Positivo Derecho e Izquierdo
Borne	Normal

39S470D-T - 39S470E-T

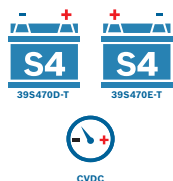

Amperaje (Ah)	70
CCA (SAE -18°C)	660
Medidas (largo/ancho/alto)	281x175x175 mm
Tipo	LIBRE MANTENCIÓN
Talón Inferior	Si
Polaridad	Positivo Derecho e Izquierdo
Borne	Normal

3965-660BCI



Amperaje (Ah)	72
CCA (SAE -18°C)	660
Medidas (largo/ancho/alto)	292x189x191 mm
Tipo	LIBRE MANTENCIÓN
Talón Inferior	Si
Polaridad	Positivo Izquierdo
Borne	Normal

3978DT-760BC



Amperaje (Ah)	72
CCA (SAE -18°C)	760
Medidas (largo/ancho/alto)	260x179x205 mm
Tipo	LIBRE MANTENCIÓN
Talón Inferior	No
Polaridad	Positivo Izquierdo
Borne	Normal y Lateral

3978-760BCI



Amperaje (Ah)	72
CCA (SAE -18°C)	760
Medidas (largo/ancho/alto)	260x179x185 mm
Tipo	LIBRE MANTENCIÓN
Talón Inferior	Si
Polaridad	Positivo Izquierdo
Borne	Lateral

39S575E-E



Amperaje (Ah)	75
CCA (SAE -18°C)	530
Medidas (largo/ancho/alto)	273x170x226 mm
Tipo	LIBRE MANTENCIÓN
Talón Inferior	Si
Polaridad	Positivo Izquierdo
Borne	Normal

39S478D-E - 39S478E-E

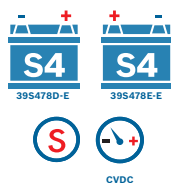

Amperaje (Ah)	78
CCA (SAE -18°C)	700
Medidas (largo/ancho/alto)	318x173x229 mm
Tipo	LIBRE MANTENCIÓN
Talón Inferior	Si
Polaridad	Positivo Derecho e Izquierdo
Borne	Normal

3958014MF



Amperaje (Ah)	80
CCA (SAE -18°C)	730
Medidas (largo/ancho/alto)	315x175x175 mm
Tipo	LIBRE MANTENCIÓN
Talón Inferior	Si
Polaridad	Positivo Derecho
Borne	Normal

3958827MF



Amperaje (Ah)	88
CCA (SAE -18°C)	850
Medidas (largo/ancho/alto)	353x175x190 mm
Tipo	LIBRE MANTENCIÓN
Talón Inferior	Si
Polaridad	Positivo Derecho
Borne	Normal

39NX120-7LMF - 39NX120-7MF

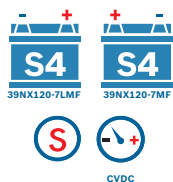

Amperaje (Ah)	90
CCA (SAE -18°C)	730
Medidas (largo/ancho/alto)	303x173x225 mm
Tipo	LIBRE MANTENCIÓN
Talón Inferior	No
Polaridad	Positivo Derecho e Izquierdo
Borne	Normal

39S590DM-E



Amperaje (Ah)	90
CCA (SAE -18°C)	850
Medidas (largo/ancho/alto)	353x175x190 mm
Tipo	LIBRE MANTENCIÓN
Talón Inferior	Si
Polaridad	Positivo Derecho
Borne	Normal

3960044MF



Amperaje (Ah)	100
CCA (SAE -18°C)	800
Medidas (largo/ancho/alto)	353x175x190 mm
Tipo	LIBRE MANTENCIÓN
Talón Inferior	Si
Polaridad	Positivo Derecho
Borne	Lateral

39N100MF



Amperaje (Ah)	100
CCA (SAE -18°C)	830
Medidas (largo/ancho/alto)	410x175x235 mm
Tipo	LIBRE MANTENCIÓN
Talón Inferior	No
Polaridad	Positivo Izquierdo
Borne	Normal

39S3100S-T



Amperaje (Ah)	100
CCA (SAE -18°C)	720
Medidas (largo/ancho/alto)	338x162x214 mm
Tipo	LIBRE MANTENCIÓN
Talón Inferior	No
Polaridad	Positivo Derecho
Borne	Pernos Centrales

39S495D-T - 39S495E-T



Amperaje (Ah)	103
CCA (SAE -18°C)	930
Medidas (largo/ancho/alto)	300x168x224 mm
Tipo	LIBRE MANTENCIÓN
Talón Inferior	No
Polaridad	Positivo Derecho e Izquierdo
Borne	Normal

39S6105S-E



Amperaje (Ah)	105
CCA (SAE -18°C)	925
Medidas (largo/ancho/alto)	330x173x237 mm
Tipo	LIBRE MANTENCIÓN
Talón Inferior	No
Polaridad	Positivo Izquierdo
Borne	Pernos Centrales

39S6105E-E



Amperaje (Ah)	105
CCA (SAE -18°C)	925
Medidas (largo/ancho/alto)	330x173x237 mm
Tipo	LIBRE MANTENCIÓN
Talón Inferior	No
Polaridad	Positivo Derecho
Borne	Normal Central

39N120MF



Amperaje (Ah)	120
CCA (SAE -18°C)	900
Medidas (largo/ancho/alto)	505x183x240 mm
Tipo	LIBRE MANTENCIÓN
Talón Inferior	Si
Polaridad	Positivo Derecho
Borne	Normal Lateral

394DLTMFT



Amperaje (Ah)	135
CCA (SAE -18°C)	815
Medidas (largo/ancho/alto)	494x220x210 mm
Tipo	LIBRE MANTENCIÓN
Talón Inferior	No
Polaridad	Positivo Izquierdo
Borne	Normal Lateral

39S3150D-T



Amperaje (Ah)	150
CCA (SAE -18°C)	1050
Medidas (largo/ancho/alto)	496x220x236 mm
Tipo	LIBRE MANTENCIÓN
Talón Inferior	No
Polaridad	Positivo Izquierdo
Borne	Normal Lateral

39N150MF



Amperaje (Ah)	150
CCA (SAE -18°C)	950
Medidas (largo/ancho/alto)	508x222x241 mm
Tipo	LIBRE MANTENCIÓN
Talón Inferior	No
Polaridad	Positivo Derecho
Borne	Normal Lateral

39S5150D-E - 39S5150E-E



Amperaje (Ah)	150
CCA (SAE -18°C)	1000
Medidas (largo/ancho/alto)	495x210x254 mm
Tipo	LIBRE MANTENCIÓN
Talón Inferior	No
Polaridad	Positivo Derecho e Izquierdo
Borne	Normal Lateral

3968032MF



Amperaje (Ah)	180
CCA (SAE -18°C)	1100
Medidas (largo/ancho/alto)	508x222x220 mm
Tipo	LIBRE MANTENCIÓN
Talón Inferior	No
Polaridad	Positivo Derecho
Borne	Normal Lateral

39N200MF



Amperaje (Ah)	200
CCA (SAE -18°C)	1130
Medidas (largo/ancho/alto)	523x279x248 mm
Tipo	LIBRE MANTENCIÓN
Talón Inferior	No
Polaridad	Positivo Derecho
Borne	Normal Lateral

3973011MF





Amperaje (Ah)	230
CCA (SAE -18°C)	1250
Medidas (largo/ancho/alto)	518x273x241 mm
Tipo	LIBRE MANTENCIÓN
Talón Inferior	No
Polaridad	Positivo Derecho
Borne	Normal Lateral

ASIA		ALTERNATIVA 1	ALTERNATIVA 2	ALTERNATIVA 3	OBSERVACIONES
TOPIC	1993 - 2003	39NX120-7LMF	39S495D-T	39S478D-E	
TOWNER	1998 - 2002	39NS40ZMF	39NS40ZLMFT	39S450DA-E	

AUDI		ALTERNATIVA 1	ALTERNATIVA 2	ALTERNATIVA 3	OBSERVACIONES
A1 1.2T-3P	2010 - 2012	39S560D-E	39S455D-E		
A1 1.4	2010 - 2012	39S560D-E	39S665D-E	39S560D	
A3 1.6 / 1.8 / 1.8T	1996 - 2005	39S665D-E	39S470D-T	39S560D	
A3 2.0T FSI	2006 - 2012	39S665D-E	39S470D-T	39S560D	
A3 2.0 TD	2006 - 2012	39S665D-E	39S470D-T	39S560D	
A3 1.2T	2008 - 2015	39S455D-E	39S560D		
A4 1.8	1994 - 2000	39S665D	39S470D-T	39S8014MF	
A4 1.8 T	1994 - 2004	39S560D	39S665D	39S470D-T	
A4 2.0	2000 - 2014	39S8014MF	39S8014MF	39S470D-T	
A4 1.8 T / 1.8 TFSI	2004 - 2013	39S8014MF	39S8014MF	39S470D-T	
A4 2.0 TFSI	2008 - 2013	39S8014MF	39S8014MF	39S470D-T	
A5 2.0 T	2010 - 2012	39S8827MF	39S590DM	3960044MF	
A5 3.2	2010 - 2012	39S8827MF	39S590DM	3960044MF	
A6 2.8	1994 - 2001	3960044MF	39S8014MF	39S590DM-E	39S8827MF
A6 2.4	1994 - 1997	39S8014MF	3960044MF	39S590DM-E	
A6 4.2	1999 - 2012	39S8014MF	39S470D-T	39S8827MF	
A6 3.0	2006 - 2004	39S8014MF	39S590DM-E		
A6 ALLROAD 3.0T	2006 - 2010	39S8827MF	39S590DM-E	3960044MF	
A6 2.0T	2010 - 2012	39S665D	39S470D-T	39S8014MF	
A8 4.2	2002 - 2012	39S8827MF	39S590DM-E	3960044MF	
Q5 2.0T	2010 - 2012	39S8014MF	39S590DM-E		
Q7 TODOS	2006 - 2012	39S590DM	3960044MF		
TT1.8T	2000 - 2006	39S665D	39S470D-T	39S8014MF	
TT 2.0 /3.2	2006 - 2013	39S470D-T	39S8014MF	3960044MF	

ALFA ROMEO		ALTERNATIVA 1	ALTERNATIVA 2	ALTERNATIVA 3	OBSERVACIONES
145 1.6/1.7	1994 - 2000	39S445D	39S560D		
146 2.0	1995 - 2000	39S455D	39S560D	39S665D	
147 1.6/2.0	2000 - 2012	39S560D	39S665D	39S470D-T	
155 2.0	1992 - 1997	39S455D	39S560D	39S665D	
156 2.0	2002 - 2005	39S560D	39S665D	39S470D-T	
159 2.2	2006 - 2012	39S560D	39S665D	39S470D-T	
166 3.0	2000 - 2012	39S465D	39S560D	39S665D	
ALFA SPIDER 1.6 / 1.8 / 2.0 / 3.0 / 3.2	2000 - 2006	39S560D	39S665D	39S470D-T	
ALFA SPIDER 2.2 / 3.2	2000 - 2006	39S665D	39S470D-T	39S8014MF	
BRERA 1.8 / 2.2	2006 - 2012	39S560D-E	39S665D	39S470D-T	
GT 1.8 / 1.9 / 2.0 / 3.2	2003 - 2012	39S560D-E	39S665D	39S470D-T	
MITO 1.4 - 3P	2010 - 2012	39S455D-E	39S560D	39S665D	
NEW GIULIETTA 1.4 - 5P	2010 - 2012	39S455D-E	39S560D	39S665D	
NEW GIULIETTA 1.4 TURBO	2010 - 2015	39S665D	39S565D		

BMW		ALTERNATIVA 1	ALTERNATIVA 2	ALTERNATIVA 3	OBSERVACIONES
116I	2006 - 2015	39S455D-E	39S560D-E	39S665D	
118I - 120I	2006 - 2015	39S665D-E	39S470D-T	39S8014MF	
120 IA 2000 A132	2007 - 2015	39S470D-T	39S8014MF		
118 - 120 - 123 TD 2.0	2006 - 2015	39S470D-T	39S8014MF	39S8827MF	
316 - 318 - 320	1982 - 2015	39S665D-E	39S470D-T	39S560D	
318 - 320 - 325 DIESEL	1995 - 2012	39S470D-T	39S8014MF	3960044MF	
323 - 325 - 328 - 330 - 335	1987 - 2014	39S470D-T	39S8014MF	3960044MF	
520 - 523 - 525 - 528 - 530 - 540	1995 - 2012	3960044MF	3960044MF	39S8827MF 39S8014MF	
X3 2.0 - 2.5 -3.0	2005 - 2012	39S470D-T	39S8014MF	3960044MF	
X3 2.0 - 3.0 DIESEL	2004 - 2012	3960044MF	39S590DM	39S8827MF	
X5 3.0 - 4.4 - 4.6 - 4.8 - 3.0D	1996 - 2012	3960044MF	39S590DM	3960044MF	
X6 3.5 / 5.0	2007 - 2012	3960044MF	39S590DM	39S8827MF	
Z3 / Z4 TODOS	1994 - 2012	39S665D	39S470D-T	39S8014MF	

BYD		ALTERNATIVA 1	ALTERNATIVA 2	ALTERNATIVA 3	OBSERVACIONES
F0 1.0	2008 - 2015	39NS40ZLMF	39S550DA-E	39NS40ZLMFT	
F3	2008 - 2017	39S5D23LMF	39S75D23LMF		
S6	2010 - 2017	39S5D23LMF	39S75D23LMF	39NX110-5LMF	

CHANGAN		ALTERNATIVA 1	ALTERNATIVA 2	ALTERNATIVA 3	OBSERVACIONES
BENNY	2008 - 2012	39NS60LMF	39S450DA-E		
CM10	2008 - 2012	39NS60LMF	39S450DA-E		
CM5	2008 - 2012	39NS60LMF	39S450DA-E		
CS1S	2016 - 2017	39S355E	39S455E-E		
CS3S	2016 - 2017	39NS60LMF	39S450DA-E		
CV12	2016 - 2017	39S355E	39S455D-E		
S100	2008 - 2015	39NS60LMF	39S450DA-E		
S200	2008 - 2015	39NS60LMF	39S450DA-E		
S300	2008 - 2015	39NS60LMF	39S450DA-E		

CHERY		ALTERNATIVA 1	ALTERNATIVA 2	ALTERNATIVA 3	OBSERVACIONES
DESTINY	2007 - 2013	39NX110-5MF	39N70MF		
FACE	2007 - 2014	39S450EA	39NS60SMF		
FULLWIN	2012 - 2016	39S355D	39S455D-E		
GRAND TIGGO	2015 - 2017	39S560D-E	39S665D	39S455D-E	
IQ	2007 - 2013	39S550EA	39NS60SMF		
S21	2007 - 2013	39S355D	39S455D-E	39S560D-E	
SKIN	2007 - 2013	39S455D	39S560D-E	39S665D	
TIGGO / TIGGO3	2007 - 2013	39NX110-5MF			

CHEVROLET		ALTERNATIVA 1	ALTERNATIVA 2	ALTERNATIVA 3	OBSERVACIONES
ASTRA 1.6 / 1.8 / 2.0	1999 - 2005	39S455D	39S560D-E	39S665D	
ASTRA 1.6 / 1.8 / 1.9TD	2005 - 2009	39S560D-E	39S665D	39S470D-T	
ASTRO VAN	1995 - 2005	3975A72MF			
AVEO TODOS	2006 - 2016	3955D23RMF	39S455E	39S560E-E	
BLAZER TODAS	1989 - 2003	3975A72MF			
CAPTIVA 2.0 DIESEL	2006 - 2012	39NX120-7MF			
CAPTIVA 2.0 / 2.4	2006 - 2012	39S560E-E	39S470E-T		
CAVALIER	1995 - 1999	3975A72MF			
COBALT	2016 - 2018	39S455D-E	39S560D-E		
CORSA /COMBO GASOLINA	1994 - 2012	39S355D	39S455D-E	39S560D-E	
CORSA /COMBO DIESEL	1994 - 2012	39S560D-E	39S470D-T	39S455D-E	
CORSA EVOLUTION	1994 - 2002	39S455D-E	39S560D-E		
CRUZE 1.8 / 2.0	2008 - 2015	39S455D-E	39S560D-E	39S665D	
CRUZE 2.0 DIESEL	2008 - 2015	39S470D-T	39S8014MF		
D-MAX BENCINA	TODAS	39N50ZMF	39NX110-5MF		
D-MAX DIESEL	2005 - 2017	39NX120-7MF	39S478E-E		
EPICA TODOS	2004 - 2008	39N50ZMF	39NX110-5MF	3975D23RMF	
EQUINOX	2004 - 2008	3975A72MF			
LUV GASOLINA	1990 - 2005	39NS60SMF	39S450EA	39S455E-E	
LUV DIESEL	1990 - 2005	39N70MF	39NX110-5MF	39NX120-7MF	
MONTANA DIESEL	2003 - 2015	39S470D-T	39S560D-E	39S8014MF	
MONTANA GASOLINA	2003 - 2015	39S455D-E	39S560D-E	39S665D	
ONIX	2016 - 2018	39S455D-E	39S560D-E		
OPTRA TODOS	2004 - 2012	39S455E-E	39S560E-E	39S5D23RMF	
ORLANDO	2014 - 2017	39S8014MF			
PRISMA	2016 - 2018	39S455D-E	39S560D-E		
S 10 AMERICANA	1994 - 2003	3975A72MF			
S 10 APACHE	2000 - 2010	39S560D-E	39S665D	39S470D-T	
S 10 APACHE DIESEL	2000 - 2012	39S470D-T	39S8014MF		
SAIL	2010 - 2018	39NS60SMF	39S445EA-E		
SILVERADO TODAS	1996 - 2001	3978-760BCI			
SONIC	2012 - 2016	39S455D-E			
SPARK LT TODOS	2008 - 2016	39NS40ZLMF	39NS40ZLMFT		
SPARK GT	2010 - 2016	39S445D	39S355D	39S455D-E	
SPIN	2016 - 2018	39S455D-E	39S560D-6		
SUBURBAN / TAHOE	2006 - 2012	3965-660BCI			
TRAILBLAZER	2002 - 2010	3978-760BCI			
TRAVERSE	2008 - 2012	39S470D-T	39S8014MF		
TROOPER	1993 - 2003	39N70MF	39NX110-5MF	39S478E-E	
UPLANDER	2005 - 2010	3955D23RMF	3975D23RMF	39NX110-5MF	
ZAFIRA TODOS	2005 - 2012	39S455D-D	39S560D-E	39S665D	

CHRYSLER		ALTERNATIVA 1	ALTERNATIVA 2	ALTERNATIVA 3	OBSERVACIONES
300C 2.7	2004 - 2009	39S8014MF	39S8827MF		
300C 3.5	2004 - 2012	39S8014MF	39S8827MF		
CARAVAN / GRAN CARAVAN / T.COUNTRY	1992 - 2010	39NX110-5MF	3978DT-760BC		
CARAVAN / GRAN CARAVAN / T.COUNTRY DIESEL	2003 - 2010	39S478E-E	39S495E-T	39NX120-7MF	
NEON	1994 - 2003	3975A72MF			
PACIFICA	2004 - 2010	39NX110-5MF			
PT CRUISER	2000 - 2010	3975A72MF			
STRATUS TODOS	1995 - 2001	39S665D	39S470D-T	39S8014MF	

CITROËN		ALTERNATIVA 1	ALTERNATIVA 2	ALTERNATIVA 3	OBSERVACIONES
AX TODOS	1987 - 1998	39S355D	39S560D-E	39S455D-E	
BERLINGO 1.4 / 1.6	2002 - 2015	39S455D-E	39S560D-E	39S470D-T	
BERLINGO/MULTIPACE					
1.9 DIESEL	1999 - 2015	39S560D-E	39S455D-E	39S470D-T	
C2 TODOS	2003 - 2012	39S445D	39S355D		
C3 TODOS	2003 - 2015	39S455D-E	39S560D-E		
C4 TODOS	2002 - 2015	39S455D-E	39S560D-E		
C5 1.8 / 2.0	2004 - 2012	39S560D-E	39S665D	39S470D-T	
C5 DIESEL TODOS	2004 - 2012	39S470D-T	39S8014MF		
C 15 GASOLINA	1990 - 1999	39S355D	39S455D-E	39S560D-E	
C 15 DIESEL	1996 - 2002	39S455D-E	39S560D-E	39S470D-T	
DS3	2013 - 2016	39S455D-E	39S560D-E		
DS4	2013 - 2016	39S455D-E	39S560D-E		
XSARA C4 VERSION PICASSO	2000 - 2011	39S665D	39S470D-T	39S8014MF	
SAXO 1.0 / 1.1	1996 - 2003	39S355D	39S455D-E	39S560D-E	
SAXO 1.4 / 1.6	1996 - 2003	39S445D	39S455D-E	39S355D	
XSARA TODOS	2000 - 2011	39S455D-E	39S560D-E		
JUMPER	2003 - 2014	39S8827MF	39S590DM	3960044MF	

DAEWOO		ALTERNATIVA 1	ALTERNATIVA 2	ALTERNATIVA 3	OBSERVACIONES
ESPERO TODOS	1991 - 1999	39S455D-E	39S560D-E		
HEAVEN	1994 - 1997	39S355D	39S455D-E	39S560D-E	
KORANDO DIESEL	1996 - 2000	39NX120-7MF	39S495E-T		
LANOS	1996 - 2003	39S455E-E	39S560E-E	39S355E	
LEGANZA	1997 - 2002	39S455E-E	39S560E-E		
MATIZ	1998 - 2003	39NS40ZLMF	39S450DA-E		
NEXIA	1994 - 2003	39S355D	39S455D-E	39S560D-E	
NUBIRA	1997 - 2005	39S5D23RMF	39S455E-E	39S560E-E	
POINTER	1994 - 2005	39S355D	39S455D-E		
PRINCE	1991 - 1996	39S5D23LMF	39S455D-E	39S560D-E	
RACER	1991 - 2003	39S355D	39S455D-E		
REZZO TODOS	2000 - 2005	39N50ZMF	39N70MF	39NX110-5MF	
TICO	1991 - 2005	39NS40ZLMF	39NS40ZLMFT	39S550DA	

DAIHATSU		ALTERNATIVA 1	ALTERNATIVA 2	ALTERNATIVA 3	OBSERVACIONES
FEROZA 1.6	1988 - 1999	39NS60SMF	39S450EA-E		
SIRION 1.3	1998 - 2004	39NS60LMF	39S450DA-E		
TERIOS 1.5	2000 - 2004	39NS60LMF	39S450DA-E		
TERIOS WILD	2005 - 2015	39NS60LMF	39S450DA-E		
YRV 1.3	2000 - 2005	39NS60LMF	39S450DA-E		

DODGE		ALTERNATIVA 1	ALTERNATIVA 2	ALTERNATIVA 3	OBSERVACIONES
CALIBER 2.0	2006 - 2012	39S560E-E			
DAKOTA	1995 - 2010	3965-660BCI			
DURANGO	1995 - 2010	3965-660BCI	3978DT-760BC		
JOURNEY	2008 - 2012	39S560E-E			
NITRO	2008 - 2012	3978DT-760BC			
RAM GASOLINA	1994 - 2001	39S495E-T	39NX120-7MF	3965-660BCI	
RAM GASOLINA	2002 - 2009	3965-660BCI			
RAM DIESEL (USA 2 BATERIAS)	2002 - 2012	39NX120-7MF	39S6105E-E	3965-660BCI	

FIAT		ALTERNATIVA 1	ALTERNATIVA 2	ALTERNATIVA 3	OBSERVACIONES
500	2010 - 2017	39S445D	39S560D-E		
BRAVO / BRAVA / DUNA	1990 - 2012	39S445D	39S355D		
CINQUECENTO	1995 - 2000	39S445D	39S355D		
DOBLO / CARGO	1990 - 2012	39S455D-E	39S560D-E		
DUCATO	2006 - 2017	3960044MF	39S8827MF	39S590DM	
FIORINO GASOLINA	1990 - 2010	39S355D	39S455D-E	39S560D-E	
FIORINO DIESEL	1990 - 2012	39S560D-E	39S470D-T		
FULLBACK	2016 - 2018	39NX120-7MF	39S495D-T		
GRANDE PUNTO	2006 - 2012	39S445D	39S355D	39S455D-E	
GRANDE PUNTO START-STOP	2015 - 2017	39LN60AGM			
IDEA	2005 - 2010	39S445D	39S355D	39S455D-E	
LINEA	2006 - 2014	39S445D	39S355D	39S455D-E	
MAREA	1996 - 2004	39S545D	39S355D	39S455D-E	
NEW FIORINO	2014 - 2017	39S445D	39S355D	39S455D-E	
PALIO TODOS	1998 - 2014	39S445D	39S355D	39S455D-E	
PUNTO	2002 - 2012	39S445D	39S355D	39S455D-E	
SIENA	2002 - 2010	39S445D	39S355D	39S455D-E	
STRADA	2002 - 2017	39S560D	39S665D-E	39S470D-T	
TEMPRA	1990 - 1996	39S455D	39S560D-E	39S665D	
TIPO	1995 - 1997	39S455D	39S560D-E	39S665D	
UNO	1983 - 1994	39S455D	39S560D-E	39S665D	
UNO WAY	2014 - 2017	39S355D	39S455D-E	39S560D-E	
WEEKEND	2000 - 2012	39S455D	39S560D-E	39S665D	

FORD		ALTERNATIVA 1	ALTERNATIVA 2	ALTERNATIVA 3	OBSERVACIONES
ECO SPORT TODAS	2003 - 2012	39S445D			
EDGE	2004 - 2012	39NX110-5LMF	39S470D-T		
ESCAPE	2001 - 2012	3965-660BCI			
EXPEDITION	1991 - 2015	3965-660BCI			
EXPLORER / SPORT TRACK	1991 - 2012	3965-660BCI	3978DT-760BC		
F150 / F250 / F350 / RAPTOR	2000 - 2017	3965-660BCI			
FIESTA	1998 - 2015	39S445D	39S455D-E		
FOCUS	2000 - 2015	39S445D			
KA	1997 - 2006	39S445D			
MONDEO	1993 - 2001	39S445D			
RANGER GASOLINA U.S.A.	1992 - 2002	3965-660BCI	39S470E-T	39S665E	
RANGER THAILANDIA	2013 - 2015	39S470D-T	3858014MF		
RANGER DIESEL THAILANDIA	2006 - 2012	39S470D-T	3958014MF		
RANGER DIESEL ARGENTINA	1998 - 2010	39S470D-T	3858014MF		
WINDSTAR	1994 - 2003	3965-660BCI			

GEELY		ALTERNATIVA 1	ALTERNATIVA 2	ALTERNATIVA 3	OBSERVACIONES
CK	2008 -2015	39S355D	39S455D-E	39S560D	
EC7	2008 - 2015	3955D23LMF	3975D23LMF		
EX7	2017 - 2017	39NX110-SLMF	3975D23LMF		
LC	2008 - 2015	39N40RMF	39NS60SMF	39S550EA	
MK	2008 - 2015	39N40RMF	39NS60SMF	39S550EA	

GREAT WALL		ALTERNATIVA 1	ALTERNATIVA 2	ALTERNATIVA 3	OBSERVACIONES
DEER	2008 - 2012	3955D23RMF	3975D23RMF		
FLORID	2008 - 2015	3955D23RMF	3975D23RMF		
GREAT WALL 3	2013 - 2016	39NX120-7MF	39NX110-5MF		
GREAT WALL 6	2016 - 2017	39NX110-5MF	39NX120-7MF		
HAVAL	2008 - 2015	3955D23RMF	3975D23RMF		
HAVAL 3	2016 - 2017	39NX110-5MF	3975D23RMF		
HOVER	2006 - 2012	39NX110-5MF	3955D23RMF	39N50ZMF	
M4	2015 - 2017	39NS60SLMF	39S450DA-E		
SAFE	2008 - 2012	3955D23RMF	3975D23RMF		
SOCOOL	2008 - 2012	3955D23RMF	3975D23RMF		
WINGLE	2008 - 2012	39S478D-E	39NX120-7LMF		
WINGLW 5	2013 - 2015	39NX110-5LMF	39NX120-7LMF		
WINGLE 6	2016 - 2017	39NX110-5LMF	39NX120-7LMF		

HAFEI		ALTERNATIVA 1	ALTERNATIVA 2	ALTERNATIVA 3	OBSERVACIONES
LOBO	2007 - 2012	39NS60SMF	39S450EA-E		
PICK UP	2007 - 2012	39NS60SMF	39S450EA-E		
FURGON CARGO	2007 - 2012	39NS60SMF	39S450EA-E		
PICK UP DOBLE CABINA	2007 - 2012	39NS60SMF	39S550EA-E		

HAIMA		ALTERNATIVA 1	ALTERNATIVA 2	ALTERNATIVA 3	OBSERVACIONES
2	2009 - 2014	39S5D23LMF	3975D23LMF		
3	2009 - 2014	39S5D23LMF	3975D23LMF		

HONDA		ALTERNATIVA 1	ALTERNATIVA 2	ALTERNATIVA 3	OBSERVACIONES
ACCORD 2.0 / 2.2 / 2.3 / 3.0	1994 - 2002	39S5D23RMF	39S560E	39S665E	
ACCORD 2.2	2003 - 2008	39S450DA-E	39S5D23LMF	39NS60LMF	
ACCORD 2.4	2003 - 2008	39S450DA-E	39S5D23LMF	39NS60LMF	
ACCORD 2.4 / 3.5	2008 - 2012	39S450DA-E	39S5D23LMF	39NS60LMF	
CIVIC 1.3 / 1.5 / 1.6	1991 - 1999	39S450DA-E	39S5D23LMF	39NS60LMF	
CIVIC	2001 - 2006	39S450DA-E	39S5D23RMF	39NS60LMF	
CIVIC 1.5 DYNO	2016 - 2017	39NS60SLMF	39S450DA-E		
CIVIC 1.8 / 2.0	2005 - 2012	39S450DA-E	39S5D23LMF	39NS60LMF	
CIVIC HYBRID 1.3 AUT	2008 - 2012	39S450DA-E	39S5D23LMF	39NS60LMF	
CR-V	1995 - 2012	39S450DA-E	39S5D23LMF	39NS60LMF	
FIT	2003 - 2012	39S450DA-E	39S5D23LMF	39NS60LMF	
HRV	2003 - 2006	39S450DA-E	39S5D23LMF	39NS60LMF	
HRV	2016 - 2017	39NS60SLMF	39S450DA-E		
INTEGRA	1993 - 2000	39S450DA-E	39S5D23LMF	39NS60LMF	
LEGEND	1992 - 2008	39N50ZMF	39NX110-5MF	39NX110-5MF	
PILOT	2006 - 2012	39N50ZLMF	39NX110-5LMF	39NX110-5LMF	
PRELUDE 1.8 / 2.0	1991 - 1999	39S450EA-E	39S5D23RMF	39N50ZMF	
PRELUDE 2.2 / 2.3	1991 - 1999	39N50ZLMF	39NX110-5LMF	39NX110-5LMF	3975D23LMF
RIDGELINE	2008 - 2012	39N50ZLMF	39NX110-5LMF	39NX110-5LMF	3975D23LMF

HYUNDAI		ALTERNATIVA 1	ALTERNATIVA 2	ALTERNATIVA 3	OBSERVACIONES
ACCENT	1994 - 2010	39S355D-E	39S455D-E	39S445D	
ACCENT DIESEL	2008 - 2010	39NX110-5LMF	39N50ZLMF		
ATOZ TODOS	1997 - 2008	39NS40ZLMF	39NS40ZLMFT		
AZERA	2007 - 2012	39S665E	39S470E-T	39NX110-5MF	
COUPE FX 2.0	1996 - 2007	39S455D-E	39S560D	39S665D	
ELANTRA	1995 - 2007	39S455D-E	39S5D23LMF	39S560D	
ELANTRA	2008 - 2010	39S455D-E	39S560D	39S5D23LMF	
ELANTRA GLS	2011 - 2018	39S455D-E	39S560D	39S5D23LMF	
ELANTRA DIESEL	2006 - 2012	39S470D-T	39S8014MF		
GALLOPER DIESEL	1991 - 1997	39S495E-T	39NX120-7MF		
GALLOPER GASOLINA	1991 - 1997	39N50ZMF	39N70MF	39NX110-5MF	
GENESIS 2,0T - 3,8	2010 - 2016	39S590DM-E			
GETZ	2002 - 2012	39S445D	39S455D-E	39S560D	
GRACE GASOLINA	1995 - 2010	39N50ZMF	39N70MF	39NX110-5MF	
GRACE DIESEL	1995 - 2010	39NX120-7MF	39S495E-T		
GRAN i10	2015 - 2017	39NS40ZLMFT	39NS40ZLMF		
H 100 / PORTER	1993 - 2015	39NX120-7MF	39S495E-T		
H-1	1993 - 2010	39NX120-7MF	39S495E-T		
i10 TODOS	2008 - 2015	39NS40ZLMF	39NS40ZLMFT		
I30	2008 - 2015	39S445D	39S560D		

HYUNDAI		ALTERNATIVA 1	ALTERNATIVA 2	ALTERNATIVA 3	OBSERVACIONES
I30 DIESEL	2008 - 2012	39S560D	39S455D-E	39S665D	
MATRIX GASOLINA	2004 - 2008	39S455D	39S560D-E	39S665D	
MATRIX DIESEL	2004 - 2008	39S560D-E	39S665D	39S470D-T	
NEW ACCENT DIESEL	2011 - 2017	39NX110-5LMF	39N50ZLMF		
NEW ACCENT BENC.	2005 - 2010	39S445D	39S5D23LMF	39S445D-E	
NEW ACCENT RV	2011 - 2017	39S445D	39S5D23LMF	39S445D-E	
NEW SONATA	2012 - 2016	39S455D	39S3D23LMF		
SANTA FE GASOLINA	2001 - 2015	39NX110-5LMF			
SANTA FE DIESEL	2001 - 2017	39NX120-7LMF	39S495D-T		
SANTAMO	1999 - 2005	39S560E-E	39S665E		
SONATA	1994 - 2005	39S455E-E	39S560E	39S665E	
SONATA	2006 - 2012	39S5D23LMF	39S560D	39S455D-E	
TERRACAN	2001 - 2009	39S495D-T	39NX120-7LMF		
TRAJET	2001 - 2007	39S560D-E	39S665D	39S470D-T	
TUCSON GASOLINA	2001 - 2017	39S55D23LMF	39S75D23LMF		
TUCSON DIESEL	2001 - 2017	39NX120-7LMF	39S495D-T		
VERACRUZ GASOLINA	2006 - 2015	39NX120-7LMF			
VERACRUZ DIESEL	2006 - 2012	39NX120-7LMF	39S495D-T		
XG25	2001 - 2005	39S470D-T	39S8014MF		

JAC MOTORS		ALTERNATIVA 1	ALTERNATIVA 2	ALTERNATIVA 3	OBSERVACIONES
137	2008 - 2012	39S355D	39S455D-E	39S560D-E	
B15	2008 - 2012	39S355D	39S455D-E	39S560D-E	
J3	2011 - 2015	39NS60SLMF	39S450DA-E		
REFINE	2008 - 2012	39NX110-5MF			
REIN	2006 - 2012	39NX120-7LMF	39S495D-T		
S2	2016 - 2017	39S5D23RMF	39S560E	39S455E-E	
S3	2016 - 2017	39S5D23LMF	39S560D	39S455D-E	
S5	2017 - 2017	39S5D23RMF	39S560E	39S455E-E	
TRIP (J6)	2008 - 2012	39S5D23LMF	39S75D23LMF		
X200	2016 - 2017	39NX120-7MF	39S495D-T		

JAGUAR		ALTERNATIVA 1	ALTERNATIVA 2	ALTERNATIVA 3	OBSERVACIONES
XJ 6 / SOVEREING TODOS	1990 - 1998	39S470D-T	39S8014MF	39S590DM	
XJ 8	1997 - 2003	39S470D-T	39S8014MF	39S590DM	
XJR	1997 - 1997	39S470D-T	39S8014MF	39S590DM	
X-TYPE	2000 - 2000	39S470D-T	39S8014MF	39S590DM	

JEEP		ALTERNATIVA 1	ALTERNATIVA 2	ALTERNATIVA 3	OBSERVACIONES
CHEROKEE	1990 - 1996	39S665E			
CHEROKEE	1997 - 2007	39S665D-E			
CHEROKEE	2008 - 2012	39S470D-T	39S8014MF	39S60044MF	
COMMANDER	2006 - 2011	39S470D-T	39S8014MF	39S60044MF	
COMMANDER DIESEL	2006 - 2011	39S8014MF	39S590DM	39S60044MF	
COMPASS	2006 - 2011	39S560E			

JEEP		ALTERNATIVA 1	ALTERNATIVA 2	ALTERNATIVA 3	OBSERVACIONES
GRAND CHEROKEE	1992 - 2007	39S665D	39S470D-T	39S8014MF	
GRAND CHEROKEE	2012 - 2017	39LN80AGM			
PATRIOT	2007 - 2011	39S560E			
WRANGLER SPORT/ RUBICON	1991 - 2011	39S665E-E	39S470E-T		

JIMBEI		ALTERNATIVA 1	ALTERNATIVA 2	ALTERNATIVA 3	OBSERVACIONES
FURGON-HAISE 2P HIGH EIV	2009 - 2014	39S495E-T	39NX120-7MF		
FURGON-HAISE 2P LOW EIV	2009 - 2014	39S495E-T	39NX120-7MF		
MINIBUS H2L	2016 - 2017	39NX120-7MF	39S495E-T		
MINIBUS-HAISE 12P ABS HIGH EIV	2009 - 2014	39S495E-T	39NX120-7MF		
MINIBUS-HAISE 12P ABS LOW EIV	2009 - 2014	39S495E-T	39NX120-7MF		

JMC		ALTERNATIVA 1	ALTERNATIVA 2	ALTERNATIVA 3	OBSERVACIONES
BOARDING	2011 - 2012	39S495E-T	39NX120-7MF		
CARRYING	2011 - 2012	39S495E-T	39NX120-7MF		
CONVEY MAX	2013 - 2017	39S495E-T	39NX120-7MF		
VIGUS 4X4 SLX	2017 - 2018	39S495E-T	39NX120-7MF		

KIA		ALTERNATIVA 1	ALTERNATIVA 2	ALTERNATIVA 3	OBSERVACIONES
AVELLA	1994 - 2000	39NS60SMF	39S450EA-E		
BESTA	1992 - 2005	39S495E-T	39NX120-7MF		
CARENS GASOLINA	1995 - 2012	39S560D	39S665D	39S470D-T	
CARENS DIESEL	1995 - 2012	39NX110-5LMF			
CARNIVAL / GRAND CARNIVAL GASOLINA	2000 - 2012	39S5D23LMF	39NX110-5LMF	3975D23LMF	
CARNIVAL / GRAND CARNIVAL DIESEL	2000 - 2012	39S495E-T	39NX120-7MF		
CERATO TODOS	2004 - 2012	39S455D-E	39S560D	39S665D-E	
CLARUS	1996 - 2001	39S455D-E	39S560D		
FRONTIER TODOS	1998 - 2012	39S495E-T	39NX120-7MF		
MAGENTIS	2005 - 2010	39NX120-7LMF	39S495D-T		
MOHAVE GASOLINA	2008 - 2011	39NX120-7LMF	39S495E-T		
MOHAVE DIESEL	2008 - 2011	39S495E-T	39NX120-7LMF		
MORNING	2004 - 2016	39NS40ZLMF	39NS40ZLMFT		
OPIRUS	2003 - 2010	39S5D23LMF	3975D23LMF	39S455D-E	
OPTIMA	2003 - 2010	39S5D23LMF	39NX110-5LMF	3975D23LMF	
PRIDE / POP	1990 - 2000	39S355D	39S455D-E	39S445D	
RIO	2000 - 2010	39S455D-E	39S355D	39S5D23LMF	
RIO	2014 - 2017	39S445D	39S355D	39S5D23LMF	
SEPHIA	1994 - 1997	39S455D-E	39S560D-E	39S665D-E	
SEPHIA	1998 - 2003	39S455E-E	39S560E-E	39S665E-E	
SORENTO GASOLINA	2002 - 2010	39S560E-E	39S665E	39NX110-5MF	3975D23LMF
SORENTO DIESEL	2002 - 2017	39NX120-7LMF	39S595D-T		

KIA		ALTERNATIVA 1	ALTERNATIVA 2	ALTERNATIVA 3	OBSERVACIONES
SOUL	2008 - 2014	3955D23LMF	3975D23LMF		
SPORTAGE GASOLINA	1998 - 2017	3955D23LMF	39NX110-5LMF	39NX110-5LMF	
SPORTAGE DIESEL	2005 - 2017	39NX120-7LMF	39S495D-T	39S478D-E	

LAND ROVER		ALTERNATIVA 1	ALTERNATIVA 2	ALTERNATIVA 3	OBSERVACIONES
DEFENDER TODOS	1990 - 2010	39S478E-E	39NX120-7MF		
DICOVERY TODOS	1995 - 2003	39S478E-E	39NX120-7MF		
DICOVERY TODOS	2004 - 2012	39S478D-E	39NX120-7LMF		
FREELANDER GASOLINA	1997 - 2007	39S560D-E	39S665D-E	39S470D-T	
FREELANDER GASOLINA	2007 - 2010	39S470D-T	39S8014MF	3960044MF	39S590DM-E
FREELANDER DIESEL	1997 - 2010	39S470D-T	39S8014MF	3960044MF	39S590DM-E
RANGE ROVER	1970 - 2002	39S470E-T	39NX110-5MF		
RANGE ROVER	2002 - 2012	39S8827MF	39S590DM	3960044MF	

LEXUS		ALTERNATIVA 1	ALTERNATIVA 2	ALTERNATIVA 3	OBSERVACIONES
GS 300	2008 - 2015	3955D23LMF	3975D23LMF		
IS 250 / 350	2008 - 2015	3955D23LMF	3975D23LMF		
RX 350 / 430 / 450	2008 - 2015	3955D23LMF	3975D23LMF		

LIFAN		ALTERNATIVA 1	ALTERNATIVA 2	ALTERNATIVA 3	OBSERVACIONES
320	2008 - 2014	39S455D-E	39S560D	39S355D	
520	2008 - 2012	39S455D-E	39S560D	39S355D	
720 1,8 CVVT	2016 - 2017	39NX110-5MF	3955D23LMF		
X50	2016 - 2017	39S455D-E			
X60	2015 - 2017	39NX110-5LMF			

MAHINDRA		ALTERNATIVA 1	ALTERNATIVA 2	ALTERNATIVA 3	OBSERVACIONES
PIK UP	2008 - 2018	39NX120-7MF	39S478D-E		
SCORPIO	2008 - 2018	39NX120-7MF	39S478D-E		
XUV 500	2008 - 2018	39NX120-7MF	39S495E-T		

MAZDA		ALTERNATIVA 1	ALTERNATIVA 2	ALTERNATIVA 3	OBSERVACIONES
2	2007 - 2015	3955D23LMF	3975D23LMF		
3	2004 - 2015	3955D23LMF	3975D23LMF		
3	2016 - 2018	39EFBQ85L			
5	2005 - 2012	3955D23LMF	3975D23LMF		
6	2001 - 2015	3955D23LMF	3975D23LMF		
121	1992 - 2002	39S355D	39S455D		
323	1991 - 2007	3955D23LMF	39S455D-E	39S560D	
626	1991 - 2001	3955D23LMF	3975D23LMF		
929	1982 - 1995	3955D23LMF	39S455D	39S355D	
ARTIS TODOS	1994 - 2001	3955D23LMF	39S455D	39S355D	
B 2200 /2500	1998 - 2004	3955D23LMF	3975D23LMF	39NX120-7MF	
B 2600 /2900	1998 - 2004	39S495E-T	39NX120-7MF		
BT50 GASOLINA	2005 - 2012	39NX110-5MF	39NX110-5MF	39NX120-7MF	

MAZDA		ALTERNATIVA 1	ALTERNATIVA 2	ALTERNATIVA 3	OBSERVACIONES
BT50 DIESEL	2005 - 2015	39S495E-T	39NX120-7MF		
CX-3	2016 - 2018	39EFBQ85L			
CX-5	2015 - 2015	3955D23LMF	3975D23LMF		
CX-5	2016 - 2018	39EFBQ85L			
CX-7	2005 - 2015	3955D23LMF	3975D23LMF		
CX-9	2009 - 2015	3975D23LMF	39NX110-5LMF		
MPV	1988 - 2000	3955D23LMF	39S665D		
MX3	1991 - 1999	39S455D	39S560D	39S665D	
MX5 / MIATA	1993 - 2010	ADAPTACION	39NS40ZLMF	39NS60LMF	
RX-8	2005 - 2012	3955D23LMF			
TRIBUTE	2001 - 2006	39S355D	39S455D	39S560D	

MERCEDES BENZ		ALTERNATIVA 1	ALTERNATIVA 2	ALTERNATIVA 3	OBSERVACIONES
SERIE A GASOLINA	1990 - 2012	39S560D	39S665D	39S470D-T	
SERIE A DIESEL	1990 - 2012	39S470D-T	39S8014MF	39S8827MF	
SERIE B GASOLINA	1990 - 2012	39S560D	39S665D	39S470D-T	
SERIE B DIESEL	1990 - 2012	39S470D-T	39S8014MF	39S8827MF	
SERIE C / CLK / CLC GASOLINA	1990 - 2012	39S665D	39S470D-T	39S8014MF	
SERIE C DIESEL	1990 - 2012	39S8827MF	39S590DM	3960044MF	
SERIE E GASOLINA	1990 - 2012	39S8827MF	39S590DM	3960044MF	
SERIE E DIESEL	1990 - 2012	39S8827MF	39S590DM	3960044MF	
SERIE GLK TODOS	2004 - 2012	39S8014MF	39S8827MF	3960044MF	
SERIE ML GASOLINA	1999 - 2012	39S8827MF	39S590DM	3960044MF	
SERIE ML DIESEL	1999 - 2012	39S8827MF	39S590DM	3960044MF	
SERIE S GASOLINA	1990 - 2010	39S8014MF	39S8827MF	3960044MF	
SERIE S DIESEL	1990 - 2010	39S8827MF	39S590DM	3960044MF	
SL/ SLK TODOS	1990 - 2010	39S470D-T	39S8014MF	39S590DM	
SPRINTER	1995 - 2015	3960044MF	39S590DM	39S8827MF	
VITO / VIANO	2009 - 2015	39S8014MF	39S8827MF	3960044MF	
190 GASOLINA	1984 - 1994	39S665D	39S470D-T	39S8014MF	
190 DIESEL	1984 - 1994	39S8014MF	39S8827MF	39S590DM	

MG		ALTERNATIVA 1	ALTERNATIVA 2	ALTERNATIVA 3	OBSERVACIONES
350	2008 - 2014	39S470D-T	39S6638MF	39S665D	
550	2008 - 2014	39S470D-T	39S6638MF	39S665D	
750	2008 - 2014	39S470D-T	39S6638MF	39S665D	
MG 3	2015 - 2017	39S455D-E	39S560D		
MG6	2008 - 2014	39S560D	39S455D-E		
MG GT	2016 - 2017	39S455D-E	39S560D		
MG SUV GS	2016 - 2017	39S560D	39S455D-E		
MG SUV ZS	2017 - 2018	39S470D-T	39S6638MF	39S665D	

MINI		ALTERNATIVA 1	ALTERNATIVA 2	ALTERNATIVA 3	OBSERVACIONES
COOPER	2002 - 2017	39S455D-E	39S560D		
COOPER PACEMAN	2007 - 2017	39S470D-T	39S8014MF		

MITSUBISHI		ALTERNATIVA 1	ALTERNATIVA 2	ALTERNATIVA 3	OBSERVACIONES
ASX	2015 - 2017	3955D23LMF	3956638MF		
COLT	1995 - 2003	39S550EA	39NS60SMF	3955D23RMF	
ECLIPSE TODOS	1990 - 2001	39N50ZMF	3865538MF	39S470D-T	
GALANT	1992 - 2007	3955D23LMF			
L200 GASOLINA	1985 - 2010	39N50ZMF	39N70MF		
L200 DAKAR / KATANA DIESEL	1990 - 2017	39NX120-7LMF	39S495D-T		
L300 GASOLINA	1995 - 2012	39S495E-T	39NX120-7MF		
L300 DIESEL	1995 - 2012	39NX120-7LMF	39S495D-T		
LANCER	1992 - 2003	39S450EA-E	3955D23RMF		
LANCER TODOS	2004 - 2012	3955D23LMF	39S560D	39S455D-E	
MONTERO SPORT GASOLINA	1992 - 2010	39NX110-5LMF	39S478D		
MONTERO DIESEL	1992 - 2010	39NX120-7LMF	39S495D-T		
MONTERO SPORT DIESEL	1996 - 2015	39NX120-7LMF	39S478D-E		
MONTERO SPORT G2	2014 - 2017	39NX120-7LMF	39S495D-T		
OUTLANDER / OUTLANDER K2	2004 - 2012	3955D23LMF	39NX110-5LMF	39NX110-5LMF	
SPACE WAGON	1994 - 2000	3955D23LMF	39NX110-5LMF	39NX110-5LMF	

NISSAN		ALTERNATIVA 1	ALTERNATIVA 2	ALTERNATIVA 3	OBSERVACIONES
ALMERA	1995 - 2000	3955D23LMF	3975D23LMF	39S455D	
D21 TODAS	1992 - 2015	3955D23RMF	39NX110-5MF		
D22 TERRANO TODAS	1998 - 2015	39NX110-5MF	39S495D-T	39NX120-7MF	
MARCH	2015 - 2018	39S445D			
MAXIMA TODOS	1995 - 1999	3955D23LMF	3975D23LMF	39NX110-5LMF	
MURANO TODOS	2004 - 2014	3955D23LMF	3975D23LMF	39NX110-5LMF	
NAVARA TODOS	2007 - 2015	39S478D-E	39NX120-7LMF		
NEW SENTRA	2007 - 2015	3955D23LMF	3975D23LMF		
NP300	2015 - 2017	39NX110-5LMF			
PATHFINDER GASOLINA	2006 - 2012	39NX110-5MF	39S495D-T	39NX120-7MF	
PATHFINDER GASOLINA	1990 - 2004	39N50ZMF	39NX110-5MF	39NX110-5MF	
PATHFINDER DIESEL	2006 - 2004	39NX110-5LMF	39S495D-T	39NX120-7LMF	
PLATINA	2003 - 2010	39S445D	39S455D-E	39S560D	
PRIMERA	1996 - 2004	3955D23LMF	3975D23LMF	39NX110-5MF	
QASHQAI	2008 - 2012	3955D23LMF	39S560D	39S455D-E	
KICKS	2017 - 2018	39S455D	39S560D		
SENTRA TODOS	1996 - 2006	39S355D	39S455D	39S560D	
TERRANO D22 DIESEL	2010 - 2015	39NX120-7MF	39S495E-T		
TERRANO (JEEP) TODOS	1988 - 1998	39N50ZMF	39NX110-5MF	39NX110-5MF	
TIIDA	2005 - 2012	39S455D-E	39S560D	39S665D	
V 16	1990 - 2012	39S355D	39S455D		
VERSA	2013 - 2018	39S455D-E			
X-TRAIL GASOLINA	2001 - 2015	3955D23LMF	39NX110-5LMF	3975D23LMF	
X-TRAIL DIESEL	2001 - 2012	39NX110-5LMF	39S495D-T	39NX120-7LMF	
350Z / 370Z	2003 - 2012	39NX110-5LMF	39S470D-T	39NX110-5LMF	

OPEL		ALTERNATIVA 1	ALTERNATIVA 2	ALTERNATIVA 3	OBSERVACIONES
ASTRA	1991 - 1999	39S355D	39S455D	39S560D	
ASTRA 1,7 CDTI	2002 - 2010	39S6638MF	39S470D-T		
ASTRA OPC	1999 - 2015	39S560D	39S455D-E		
COMBO	1994 - 1999	39S355D	39S455D	39S560D	
COMBO DIESEL	1994 - 1999	39S470D-T	39S8014MF		
CORSA	1998 - 1999	39S355D	39S455D-E	39S560D	
CORSA	2000 - 2014	39S560D	39S455D-E		
OMEGA	1995 - 1999	39S560D	39S665D	39S470D-T	
KADETT	1986 - 1999	39S355D	39S455D-E	39S560D	
VECTRA	1990 - 1999	39S455D-E	39S560D		
ZAFIRA	2001 - 2010	39S455D-E	39S560D		

PEUGEOT		ALTERNATIVA 1	ALTERNATIVA 2	ALTERNATIVA 3	OBSERVACIONES
106 TODOS	1992 - 2005	39S455D-E	39S355D		
107 TODOS	2005 - 2012	39S455D-E	39S355D		
205 TODOS	1983 - 1998	39S455D-E	39S355D		
206 GASOLINA	1998 - 2011	39S455D-E	39S355D	39S560D	
206 DIESEL	1998 - 2011	39S560D	39S455D-E	39S665D	
207 GASOLINA	2008 - 2015	39S355D	39S455D-E	39S560D	
207 DIESEL	2006 - 2012	39S560D	39S665D	39S455D-E	
208	2012 - 2017	39S455D-E	30D560D	39S355D	
301 DIESEL	2012 - 2017	39S560D	39S455D-E		
306	1993 - 2003	39S355D	39S455D-E	39S560D	
307 GASOLINA	2000 - 2010	39S355D	39S455D-E	39S560D	
307 DIESEL	2000 - 2010	39S560D	30S665D	39S455D-E	
308 GASOLINA	2007 - 2017	39S455D-E	39S560D		
308 DIESEL	2007 - 2012	39S560D	39S665D	39S470D-T	
405	1987 - 1997	39S455D-E	39S560D	39S355D	
406 GASOLINA	1999 - 2004	39S455D-E	39S560D	39S355D	
406 DIESEL	1999 - 2004	39S560D	39S665D	39S470D-T	
407 GASOLINA	1999 - 2012	39S455D-E	39S560D	39S665D	
407 DIESEL	1999 - 2012	39S560D	39S665D	39S470D-T	
508	2010 - 2017	39S6639MF	39S470D-T	39S560D	
605	1989 - 1999	39S455D-E	39S560D	39S665D	
607 GASOLINA	2000 - 2010	39S470D-T	39S8014MF	39S590DM	
607 DIESEL	2000 - 2012	39S470D-T	39S8014MF	39S590DM	
2008	2011 - 2017	39S560D	39S665D	39S455D-E	
3008	2011 - 2017	39S470D-T	39S8014MF	39S590DM	
BOXER TODAS	1994 - 2015	39S60044MF	39S590DM	39S8827MF	
EXPERT	2007 - 2012	39S8014MF	39S470D-T	39S590DM	
PARTNER	1996 - 2015	39S470D-T	39S560D		

PORSCHE		ALTERNATIVA 1	ALTERNATIVA 2	ALTERNATIVA 3	OBSERVACIONES
911 / CARRERA	1985 - 2011	39S470D-T	39S8014MF	39S60044MF	
BOXSTER	1995 - 2012	39S8014MF	39S590DM	39S60044MF	
CAYENNE	2002 - 2012	39S590DM	39S60044MF		

RENAULT		ALTERNATIVA 1	ALTERNATIVA 2	ALTERNATIVA 3	OBSERVACIONES
ALASKAN pick up	2017 - 2018	39NX110-5LMF			
CLIO GASOLINA	1990 - 2012	39S445D	39S455D-E	39S560D	
CLIO RS NEW	2015 - 2017	39S560D	39S455D-E		
CLIO DIESEL	1990 - 2012	39S560D	39S665D	39S470D-T	
DUSTER	2014 - 2018	39S560D	39S455D-E		
FLUENCE	2005 - 2017	39S560D	39S665D	39S470D-T	
KANGOO GASOLINA	1998 - 2010	39S445D	39S455D-E	39S560D	
KANGOO DIESEL	1998 - 2015	39S470D-T	39S8014MF		
KOLEOS	2008 - 2016	39NX110-5MF			
LAGUNA GASOLINA	1992 - 2017	39S560D	39S665D	39S470D-T	
LAGUNA DIESEL	1992 - 2010	39S470D-T	39S8014MF		
LATITUDE	2006 - 2012	39S560D	39S665D	39S470D-T	
LOGAN	2007 - 2017	39S455D-E	39S560D	39S665D	
MEGANE GASOLINA	1996 - 2017	39S455D-E	39S560D	39S665D	
MEGANE DIESEL	1996 - 2012	39S470D-T	39S8014MF		
OROCH	2017 - 2018	39S560D	39S455D-E		
SANDERO	1998 - 2015	39S455D-E	39S560D	39S665D	
STEPWAY	2005 - 2017	39S455D-E	39S560D	39S665D	
SCENIC TODOS	1998 - 2010	39S560D	39S665D	39S470D-T	
SYMBOL	2005 - 2017	39S455D-E	39S560D	39S665D	
TWINGO	1998 - 2004	39S445D	39S455D-E	39S560D	

SAMSUNG		ALTERNATIVA 1	ALTERNATIVA 2	ALTERNATIVA 3	OBSERVACIONES
SM3 1.6	2000 - 2014	39S5D23LMF	39S75D23LMF	39S560D	
SM5 2.0	2000 - 2014	39S5D23LMF	39S75D23LMF	39S560D	
SM7 2.3	2000 - 2014	39S5D23LMF	39S75D23LMF	39S560D	
SM7 3.5	2000 - 2014	39S5D23LMF	39S75D23LMF	39S560D	

SEAT		ALTERNATIVA 1	ALTERNATIVA 2	ALTERNATIVA 3	OBSERVACIONES
IBIZA / CORDOVA	1984 - 2001	39S355D	39S455D	39S560D	

SKODA		ALTERNATIVA 1	ALTERNATIVA 2	ALTERNATIVA 3	OBSERVACIONES
FABIA GASOLINA	2000 - 2012	39S455D	39S665D	39S470D-T	
FABIA DIESEL	2000 - 2012	39S470D-T	39S8014MF	39S8827MF	
OCTAVIA GASOLINA	2000 - 2012	39S455D	39S665D	39S470D-T	
OCTAVIA DIESEL	2000 - 2012	39S470D-T	39S8014MF	39S8827MF	

SSANGYONG		ALTERNATIVA 1	ALTERNATIVA 2	ALTERNATIVA 3	OBSERVACIONES
ACTYON GASOLINA	2005 - 2015	39NX110-5MF	39NX110-5MF	39NX120-7MF	
ACTYON / SPORT DIESEL	2005 - 2017	39S495E-T	39NX120-7MF		
KORANDO TODOS	2005 - 2017	39S495E-T	39NX120-7MF		
KYRON	2005 - 2012	39S495E-T	39NX120-7MF		
MUSSO GASOLINA	1996 - 2005	39S5D23LMF	39S75D23LMF	39NX110-5LMF	
MUSSO DIESEL	1996 - 2005	39S495E-T	39NX120-7MF		
REXTON TODOS	2001 - 2014	39S495E-T	39NX120-7MF		

SSANGYONG		ALTERNATIVA 1	ALTERNATIVA 2	ALTERNATIVA 3	OBSERVACIONES
TIVOLI	2015 - 2017	3955D23LMF	39S560D		
STAVIC TODOS	2005 - 2015	39S495E-T	39NX120-7MF		

SUBARU		ALTERNATIVA 1	ALTERNATIVA 2	ALTERNATIVA 3	OBSERVACIONES
FORESTER TODOS	1997 - 2005	3955D23LMF	3975D23LMF	39NX110-5LMF	
IMPREZA TODOS	1992 - 2015	3955D23LMF	3975D23LMF	39NX110-5LMF	
LEGACY TODOS	1992 - 2015	3955D23LMF	3975D23LMF	39NX110-5LMF	
OUTBACK TODOS	1995 - 2012	3955D23LMF	3975D23LMF	39NX110-5LMF	
XV	2011 - 2013	3955D23LMF			
NEW XV	2016 - 2018	39EFB-Q85L			
TRIBECA	2005 - 2014	3955D23LMF	3975D23LMF	39NX110-5LMF	

SUZUKI		ALTERNATIVA 1	ALTERNATIVA 2	ALTERNATIVA 3	OBSERVACIONES
AERIO / LIANA	2001 - 2008	39NS60LMF	39S450DA-E	39NS40ZLMFT	
ALTO	2002 - 2015	39NS40ZLMF	39NS60LMF		
APV / MINI VAN	2006 - 2012	39NS40ZMF	39S450EA-E		
BALENO	1995 - 2005	39NS60LMF	39NS40ZLMFT	39S450DA-E	
BALENO NEW	2016 - 2018	39S455D-E	39S560D		
CARRY	1980 - 2009	39NS40ZMF	39S450EA-E		
CELERIO	2009 - 2012	39NS40ZMF	39S450EA-E		
IGNIS	2000 - 2012	39NS60LMF	39S450DA-E		
IGNIS NEW	2017 - 2018	39NS60LMF	39S450DA-E		
JIMNY	1998 - 2015	39NS60SMF	39S450EA-E		
KIZASHI	2008 - 2015	3955D23LMF	3975D23LMF	39S560D	
MARUTI	1992 - 2015	39NS40ZLMF	39S450DA-E		
NOMADE / GRAN NOMADE GASOLINA	1998 - 2012	3955D23LMF	3975D23LMF	39NX110-5LMF	
NOMADE / GRAN NOMADE DIESEL	1998 - 2012	39NX120-7LMF	39S495D-T	39S478D-E	
SAMURAI / SJ TODOS	1984 - 2004	39NS40ZMF	39S450EA-E		
SWIFT	2002 - 2012	39NS60SMF	39S450EA-E		
NEW SWIFT	2013 - 2017	39NS60MF	39S450EA-E		
SX4	2007 - 2012	39NS60MF	39A450DA-E		
VITARA / GRAN VITARA GASOLINA	1992 - 2006	3955D23LMF	3975D23LMF	39NX110-5LMF	
GRAND VITARA 3 PTAS	2006 - 2015	39NS60LMF	39S450DA-E		
VITARA / GRAN VITARA DIESEL	1992 - 2012	39S478D-E	39NX120-7LMF		
XL7 GASOLINA	1998 - 2012	39NX110-5LMF	39S478D-E	39NX120-7LMF	
XL7 DIESEL	1998 - 2012	39S478D-E	39NX120-7LMF		

TATA		ALTERNATIVA 1	ALTERNATIVA 2	ALTERNATIVA 3	OBSERVACIONES
XENON 2.2	2011 - 2015	39NX110-5LMF	39NX110-5LMF		

TOYOTA		ALTERNATIVA 1	ALTERNATIVA 2	ALTERNATIVA 3	OBSERVACIONES
4 RUNNER TODOS	1992 - 2014	39NX110-5LMF	39NX110-5LMF	3975D23LMF	
AURIS	2007 - 2012	39S550DA	3955D23LMF		
AURIS	2014 - 2017	39S455D-E	39S560D		
AVENSIS	1998 - 2012	39S455D-E	39S560D		
CAMRY TODOS	1992 - 2012	39S450DA-E	3955D23LMF		
COROLLA	1992 - 2012	39S450DA-E	39S545D	3955D23LMF	
COROLLA NEW	2016 - 2018	3955D23LMF	39S560D	39S455D-E	
FJ CRUISER	2008 - 2015	3955D23LMF	39NX110-5LMF		
FORTUNER	2006 - 2012	39NX110-5LMF	3975D23LMF	39NX110-5LMF	
HIACE	1992 - 2012	39S478E-E	39S495E-T	39NX120-7MF	
HILUX GASOLINA	1992 - 2005	39S455E	39S560E	39S470E-T	
HILUX GASOLINA	2006 - 2012	39NX110-5LMF	3975D23LMF	39NX110-5LMF	
HILUX DIESEL	1992 - 2005	39NX110-5MF	39NX120-7MF		
HILUX DIESEL	2006 - 2012	39NX110-5LMF	3975D23LMF		
LAND CRUISER TODOS	2005 - 2012	39NX110-5LMF	3975D23LMF	39NX110-5LMF	
NEW HILUX THAILANDIA	2016 - 2017	39S470D-T	39S6638MF		
PRADO	2010 - 2017	39NX1207LMF	39S495D-T		
RAV4	1996 - 2017	3955D23LMF	3975D23LMF	39NX110-5LMF	
RUSH	2017 - 2018	39NS60LMF	39S450EA-E		
TERCEL / PASEO	1990 - 2003	39NS40ZLMF	39S450DA-E	39NS60LMF	
TUNDRA / SEQUOIA	2009 - 2015	39NX110-5LMF	39S8014MF	39NX120-7LMF	
URBAN CRUISER 1.6	2008 - 2016	39NS60LMF	39S450DA-E		
YARIS	2002 - 2005	39NS60SMF	39S450EA-E		
NEW YARIS	2006 - 2016	39NS60SLMF	39S450DA-E		

VOLKSWAGEN		ALTERNATIVA 1	ALTERNATIVA 2	ALTERNATIVA 3	OBSERVACIONES
AMAROK	2010 - 2017	39S590DM	3960044MF		
BEETLE TODOS	1999 - 2012	39S560D	39S665D	39S470D-T	
BORA GASOLINA	1999 - 2017	39S560D	39S665D	39S455D-E	
BORA DIESEL	1999 - 2012	39S470D-T	39S8014MF		
ESCARABAJO	1980 - 2000	39S455E-E	39S560E	39S665E	
FOX /CROSSFOX	2002 - 2014	39S455D	39S560D	39S665D	
GOL TODOS	1982 - 2017	39S455D-E	39S560D	39S665D	
GOLF / VENTO	1988 - 2017	39S455D-E	39S560D	39S665D	
KOMBI TODOS	1984 - 1997	39S465E	39S470E-T		
PASSAT GASOLINA	1994 - 2012	39S560D	39S470D-T	39S8014MF	
PASSAT DIESEL	1994 - 2012	39S560D	39S470D-T	39S590DM	
POLO TODOS	1994 - 2012	39S455D-E	39S560D	39S665D	39S355D
SAVEIRO	1988 - 2015	39S455D	39S560D	39S665D	
SURAN HIGHLINE	2008 - 2012	39S560D	39S470D-T	39S8014MF	
TIGUAN	2007 - 2015	39S560D	39S470D-T	39S8014MF	
TOUAREG GASOLINA	2006 - 2017	39S8014MF	39S8827MF	39S590DM	3960044MF
TOUAREG DIESEL	2006 - 2015	39S8827MF	39S590DM	3960044MF	
TRANSPORTER	1992 - 2015	39S470D-T	39S8014MF	39S8827MF	
VENTO GASOLINA	1988 - 2017	39S455D	39S560D	39S665D	
VENTO DIESEL	1988 - 2012	39S470D-T	39S8014MF	39S8827MF	

VOLVO		ALTERNATIVA 1	ALTERNATIVA 2	ALTERNATIVA 3	OBSERVACIONES
460	1990 - 1998	39S455D	39S560D	39S665D	
850	1992 - 1998	39S455D	39S560D	39S665D	
C30	2006 - 2012	39S560D	39S665D	39S470D-T	
C70	2001 - 2012	39S560D	39S665D	39S470D-T	
S40	2000 - 2012	39S665D	39S470D-T	39S8014MF	
S60 GASOLINA	2000 - 2012	39S560D	39S665D	39S470D-T	
S60 DIESEL	2000 - 2012	39S8827MF	39S590DM	3960044MF	
S70	1997 - 2000	39S560D	39S665D	39S470D-T	
S80 GASOLINA	1999 - 2012	39S665D	39S470D-T	39S8014MF	
S80 DIESEL	1999 - 2012	39S8827MF	39S590DM	3960044MF	
V40 GASOLINA	1996 - 2017	39S560D	39S665D	39S470D-T	
V40 DIESEL	1999 - 2012	39S470D-T	39S8014MF	39S590DM	
V50 GASOLINA	2001 - 2012	39S470D-T	39S8014MF	39S590DM	
V50 DIESEL	2001 - 2012	39S8014MF	39S590DM	3960044MF	
V70 GASOLINA	2001 - 2015	39S470D-T	39S8014MF	39S590DM	
V70 DIESEL	2001 - 2012	39S8014MF	39S590DM	3960044MF	
XC 60 GASOLINA	2001 - 2015	39S470D-T	39S8014MF	39S590DM	
XC 60 DIESEL	2001 - 2015	39S8014MF	39S590DM	3960044MF	
XC 70 GASOLINA	2001 - 2015	39S8014MF	39S590DM	3960044MF	
XC 70 DIESEL	2001 - 2012	39S8827MF	39S590DM	3960044MF	
XC 90 GASOLINA	2003 - 2015	39S8014MF	39S590DM	3960044MF	
XC 90 DIESEL	2003 - 2015	39S8827MF	39S590DM	3960044MF	

ZNA		ALTERNATIVA 1	ALTERNATIVA 2	ALTERNATIVA 3	OBSERVACIONES
RICH	2008 - 2012	39NX110-5MF	39N50ZMF		
SUCCE	2008 - 2012	39NX110-5MF	39N50ZMF		

ZOTYE		ALTERNATIVA 1	ALTERNATIVA 2	ALTERNATIVA 3	OBSERVACIONES
HUNTER 1.3	2008 - 2014	39NS60LMF	39S450DA-E		
HUNTER 1.5	2008 - 2014	39NS60LMF	39S450DA-E		
HUNTER 1.3	2008 - 2014	39NS60LMF	39S450DA-E		
HUNTER 1.5	2008 - 2014	39NS60LMF	39S450DA-E		

ZX AUTO		ALTERNATIVA 1	ALTERNATIVA 2	ALTERNATIVA 3	OBSERVACIONES
ADMIRAL 2.2	2008 - 2012	39NX110-5MF	39N50ZMF		
GRANDTIGER 2.2	2008 - 2015	39NX110-5MF	39N50ZMF		

Baterías Start-Stop

El creciente número de consumidores eléctricos en los vehículos modernos y las exigencias especiales como los sistemas Start/Stop y de recuperación de la energía de frenada requieren de baterías con máximas prestaciones

Tecnología AGM: fuerza máxima para la mayor potencia

Las baterías con tecnología AGM (Absorbent Glass Mat) disponen de esteras de microfibras de vidrio especiales colocadas entre las placas de plomo de la batería que recogen todo el ácido. La elevada presión de compresión minimiza la pérdida del material activo en caso de resistencia interior extremadamente baja. Mediante la reacción más rápida entre el ácido y el material de la placa se pueden producir cantidades de energía más elevadas en situaciones exigentes.

Relación de las baterías de Bosch: a medida para todos los sistemas

En los vehículos equipados de fábrica con baterías AGM, se deben montar baterías AGM al realizar el cambio de batería. De lo contrario se perjudicaría el funcionamiento del sistema Start/Stop y sus efectos positivos. En ese caso disminuye la vida útil de la batería.

Ventajas

- Mayor vida útil y estabilidad del ciclo hasta 4 veces mayor en comparación con las baterías de arranque convencionales
- Potencia constante también en recorridos cortos, tráfico con paradas y arranques frecuentes o consumo elevado con el vehículo parado
- Toma de carga y potencia de arranque excepcionales con gran número de consumidores eléctricos
- Sin ningún tipo de mantenimiento
- Montaje posible en cualquier situación y segura contra derramamiento
- Calidad de primera clase de Bosch

Tecnología EFB: rendimiento por encima de los mayores estándares

En la tecnología EFB la placa positiva está cubierta con el denominado scrim de poliéster. El material activo adquiere de esa forma una adherencia adicional a la placa. La estabilidad del ciclo aumenta en comparación con las baterías tradicionales y la batería permanece también lista para su utilización en caso de vibraciones fuertes.

La tecnología EFB es especialmente adecuada para vehículos con sistema Start/Stop. Su elevada estabilidad del ciclo pone a disposición en todo momento suficiente energía para el nuevo arranque del vehículo. Incluso cuando hay conectados al vehículo una gran cantidad de consumidores eléctricos durante la fase de parada, su potencia de arranque es excepcional.

Ventajas

- Mayor vida útil y estabilidad del ciclo doble en comparación con las baterías de arranque convencionales
- Arranque seguro también a temperaturas extremas y con gran cantidad de consumidores eléctricos
- Toma de carga especialmente buena y elevada estabilidad en recorridos cortos
- Con scrim de poliéster adicional entre la placa y el separador
- Segura contra el vuelco y el derrame hasta 55°
- Calidad de primera clase de Bosch
- Sin ningún tipo de mantenimiento

	TECNOLOGÍA AGM	TECNOLOGÍA EFB	TECNOLOGÍA POWERFRAME
Función Primaria	El despliegue de Start/Stop en conjunto con la recuperación de energía de frenado requiere una batería con un rendimiento superior.	Muchos arranques necesitan más energía: el sistema de Start/Stop conduce a un perfil de carga completamente nuevo para la batería.	En vehículos convencionales, los requisitos de batería de los ciclos de carga / descarga están en el rango "normal"
Tecnología	AGM	EFB	PowerFrame®
Sistema Start/Stop	✓	✓	
Recuperación de energía de frenado	✓		
Alta cantidad de elementos de consumo	✓✓✓	✓	✓
Frecuencia de distancias cortas	✓✓✓	✓✓	✓

39LN60AGM



Amperaje (Ah)	60
CCA (SAE -18°C)	680
RC min	100
Medidas (largo/ancho/alto)	241x174x190 mm
Tipo	AGM
Polaridad	Positivo Derecho
Borne	Normal

39LN70AGM



Amperaje (Ah)	70
CCA (SAE -18°C)	760
RC min	120
Medidas (largo/ancho/alto)	277x174x190 mm
Tipo	AGM
Polaridad	Positivo Derecho
Borne	Normal

39LN80AGM



Amperaje (Ah)	80
CCA (SAE -18°C)	800
RC min	140
Medidas (largo/ancho/alto)	314x174x190 mm
Tipo	AGM
Polaridad	Positivo Derecho
Borne	Normal

39LN95AGM



Amperaje (Ah)	92
CCA (SAE -18°C)	850
RC min	160
Medidas (largo/ancho/alto)	352x174x190 mm
Tipo	AGM
Polaridad	Positivo Derecho
Borne	Normal

39EFB-Q85L



Amperaje (Ah)	65
CCA (SAE -18°C)	550
RC min	110
Medidas (largo/ancho/alto)	232x173x205 mm
Tipo	EFB
Polaridad	Positivo Derecho
Borne	Normal

39EFB-60



Amperaje (Ah)	60
CCA (SAE -18°C)	550
RC min	100
Medidas (largo/ancho/alto)	245x175x189 mm
Tipo	EFB
Polaridad	Positivo Derecho
Borne	Normal

39EFB-70



Amperaje (Ah)	70
CCA (SAE -18°C)	680
RC min	120
Medidas (largo/ancho/alto)	277x175x189 mm
Tipo	AGM
Polaridad	Positivo Derecho
Borne	Normal

ASTON MARTIN	ALTERNATIVA 1	ALTERNATIVA 2	ALTERNATIVA 3	OBSERVACIONES
087 5.9 V12 Vantage	39LN95AGM			

AUDI	ALTERNATIVA 1	ALTERNATIVA 2	ALTERNATIVA 3	OBSERVACIONES
A1 1.4 TFSI	39LN80AGM			
A6 2.4	39LN70AGM			
A6 2.0TFSI	39LN95AGM			
A4 2.0 TFSI	39LN70AGM			
A4 2.0 TFSI quattro	39LN70AGM			
Q7 3.6 FSI	39LN95AGM			
A5 3.2 FSI Coupe quattro	39LN95AGM			
S5 4.2 Coupe quattro	39LN95AGM			
A3 1.8 TFSI	39LN70AGM			
A3 2.0TFSI	39LN70AGM			
A4 1.8 TFSI	39LN70AGM			
A4 2.0 TFSI Avant	39LN70AGM			
A5 2.0 TFSI Coupe quattro	39LN70AGM			
Q5 2.0 TFSI quattro	39LN80AGM			
Q5 3.2 FSI quattro	39LN95AGM			
A5 2.0 TFSI Sportback quattro	39LN70AGM	39LN95AGM*		
A1 1.4 TFSI	39LN95AGM			
A8 3.0 TFSI quattro	39LN70AGM	39LN95AGM*		
A7 2.8 FSI Sportback quattro	39LN95AGM			
Q7 3.0TFSI	39LN80AGM			
A6 2.8 FSI	39LN80AGM			
A6 2.0 TFSI	39LN95AGM			

BENTLEY	ALTERNATIVA 1	ALTERNATIVA 2	ALTERNATIVA 3	OBSERVACIONES
Continental 6.0 Flying Spur	39LN95AGM			
Continental 6.0 GT	39LN95AGM			

BMW	ALTERNATIVA 1	ALTERNATIVA 2	ALTERNATIVA 3	OBSERVACIONES
130 i	39LN70AGM			
118 i	39LN70AGM	39LN80AGM*	39LN95AGM*	
135 i Coupe	39LN70AGM	39LN95AGM*		
120 i Coupe	39LN70AGM	39LN95AGM*		
130 i	39LN70AGM	39LN95AGM*		
116 i	39LN70AGM	39LN95AGM*		
118 i	39LN70AGM	39LN80AGM	39LN95AGM*	
120 i	39LN70AGM	39LN95AGM*		
120 i Cabriolet	39LN70AGM	39LN80AGM*	39LN95AGM*	
335 i	39LN70AGM	39LN80AGM*	39LN95AGM*	
320 i	39LN70AGM	39LN80AGM*	39LN95AGM*	

BMW	ALTERNATIVA 1	ALTERNATIVA 2	ALTERNATIVA 3	OBSERVACIONES
323 i	39LN70AGM	39LN80AGM*	39LN95AGM*	
325 i	39LN70AGM	39LN80AGM*	39LN95AGM*	
330 i	39LN70AGM	39LN80AGM*	39LN95AGM*	
330 xi	39LN70AGM	39LN80AGM*	39LN95AGM*	
325 xi	39LN70AGM	39LN80AGM*	39LN95AGM*	
M3	39LN70AGM	39LN80AGM*	39LN95AGM*	
320 i Touring	39LN70AGM	39LN80AGM*	39LN95AGM*	
325 i Touring	39LN70AGM	39LN80AGM*	39LN95AGM*	
335 i Touring	39LN70AGM	39LN80AGM*	39LN95AGM*	
320 i Coupe	39LN70AGM	39LN80AGM*	39LN95AGM*	
335 i Coupe	39LN70AGM	39LN80AGM*	39LN95AGM*	
325 i Coupe	39LN70AGM	39LN80AGM*		
M3 Coupe	39LN70AGM	39LN80AGM	39LN95AGM*	
335 i Cabriolet	39LN70AGM	39LN80AGM*	39LN95AGM*	
328 i	39LN95AGM			
320 i	39LN95AGM			
540 i	39LN95AGM			
550 i	39LN80AGM	39LN95AGM		
M5	39LN95AGM			
520 i	39LN80AGM	39LN95AGM*		
525 i	39LN95AGM			
530 i	39LN95AGM			
550 i Touring	39LN95AGM			
525 i Touring	39LN95AGM			
530 i Touring	39LN95AGM			
530 xi Touring	39LN95AGM			
550 i GT	39LN80AGM	39LN95AGM*		
535 i GT	39LN80AGM	39LN95AGM*		
535 i	39LN80AGM	39LN95AGM *		
528 i	39LN80AGM	39LN95AGM*		
523 i Touring	39LN80AGM	39LN95AGM		
528 i Touring	39LN80AGM	39LN95AGM*		
535 i Touring	39LN80AGM	39LN95AGM*		
650 i	39LN95AGM			
M6	39LN95AGM			
630 i	39LN95AGM			
645 Ci	39LN95AGM			
650 i Cabriolet	39LN95AGM			
630 i Cabriolet	39LN95AGM			
645 Ci Cabriolet	39LN95AGM			
640 i Cabriolet	39LN95AGM			
730 i	39LN95AGM			
740 i	39LN95AGM			

BMW	ALTERNATIVA 1	ALTERNATIVA 2	ALTERNATIVA 3	OBSERVACIONES
750 i	39LN95AGM			
735 i	39LN95AGM			
745 i	39LN95AGM			
750 Li	39LN95AGM			
745 Li	39LN95AGM			
760 Li	39LN95AGM			
740 Li	39LN95AGM			
X1 sDrive 18 i	39LN80AGM			
X3 2.5 i	39LN80AGM	39LN95AGM*		
X5 4.8i	39LN95AGM			
X5 M	39LN95AGM			
X5 xDrive 35 i	39LN95AGM			
X6 xDrive 35 i	39LN95AGM			
X6 xDrive 50 i	39LN95AGM			
X6 M	39LN95AGM			
Z4 sDrive 23	39LN80AGM			

CITROËN	ALTERNATIVA 1	ALTERNATIVA 2	ALTERNATIVA 3	OBSERVACIONES
C5 2.0i Break	39LN70AGM			
C5 1.6THP	39LN70AGM			

FERRARI	ALTERNATIVA 1	ALTERNATIVA 2	ALTERNATIVA 3	OBSERVACIONES
F 430 Coupe	39LN70AGM			

FIAT	ALTERNATIVA 1	ALTERNATIVA 2	ALTERNATIVA 3	OBSERVACIONES
Grande Punto 1.4	39LN60AGM			
Fiorino 1.3 Multijet	39LN70AGM			
Doblo Cargo 1.3 Multijet	39LN60AGM			

JEEP	ALTERNATIVA 1	ALTERNATIVA 2	ALTERNATIVA 3	OBSERVACIONES
Grand Cherokee 3.6 VVT	39LN80AGM			

JAGUAR	ALTERNATIVA 1	ALTERNATIVA 2	ALTERNATIVA 3	OBSERVACIONES
Grand Cherokee 3.6 VVT	39LN80AGM			

LAND ROVER	ALTERNATIVA 1	ALTERNATIVA 2	ALTERNATIVA 3	OBSERVACIONES
Discovery IV 3.0 SDV6 AWD	39LN95AGM			

MERCEDES BENZ	ALTERNATIVA 1	ALTERNATIVA 2	ALTERNATIVA 3	OBSERVACIONES
A200 Turbo	39LN80AGM			
A170	39LN70AGM			
B160	39LN70AGM			

MERCEDES BENZ	ALTERNATIVA 1	ALTERNATIVA 2	ALTERNATIVA 3	OBSERVACIONES
B200	39LN70AGM	39LN80AGM*		
C250CGI	39LN60AGM	39LN80AGM*		
C63AMG	39LN60AGM			
C200CGI	39LN60AGM			
C230	39LN70AGM			
C300	39LN60AGM			
C 350 CGI	39LN60AGM			
C 200 KOMPRESSOR	39LN70AGM			
C 180 KOMPRESSOR	39LN70AGM			
C 63 AMG Coupe	39LN60AGM			
C 250 CGI Stationwagon	39LN60AGM			
C 63 AMG Stationwagon	39LN60AGM			
C 200 CGI Stationwagon	39LN60AGM			
C 200 KOMPRESSOR T-Modell	39LN95AGM			
CL 500 Coupe	39LN95AGM			
CL 600 Coupe	39LN95AGM			
CL 55 AMG KOMPRESSOR Coupe	39LN95AGM			
CL 65 AMG Coupe	39LN95AGM			
CL 550 Coupe	39LN95AGM			
CL 63 AMG Coupe	39LN95AGM			
CLC 180 KOMPRESSOR	39LN70AGM			
CLS 550 Coupe	39LN95AGM			
CLS 500 Coupe	39LN95AGM			
CLS 55 AMG Coupe	39LN95AGM			
CLS 350 Coupe	39LN95AGM			
CLS 63 AMG Coupe	39LN95AGM			
E 200 CGI Coupe	39LN80AGM			
E 250 CGI Coupe	39LN80AGM			
E 500	39LN95AGM	39LN80AGM		
E 230	39LN95AGM			
E 250	39LN95AGM			
E 280	39LN95AGM			
E 300	39LN95AGM	39LN80AGM		
E 350	39LN95AGM	39LN80AGM		
E 63 AMG	39LN95AGM	39LN80AGM		
E 350 4MATIC	39LN95AGM	39LN80AGM		
E 240	39LN95AGM			
E 320	39LN95AGM			
E 55 AMG KOMPRESSOR	39LN95AGM			
E 320 4MATIC	39LN95AGM			
E 320 CDI	39LN95AGM			

MERCEDES BENZ	ALTERNATIVA 1	ALTERNATIVA 2	ALTERNATIVA 3	OBSERVACIONES
E 550 Stationwagon	39LN95AGM	39LN80AGM		
E 250 Stationwagon	39LN95AGM			
E 280 Stationwagon	39LN95AGM			
E 350 Stationwagon	39LN95AGM	39LN80AGM		
E 350 4MATIC Stationwagon	39LN95AGM	39LN80AGM		
E 240 Stationwagon	39LN95AGM			
E 320 Stationwagon	39LN95AGM			
E 500 Stationwagon	39LN95AGM			
E 55 AMG KOMPRESSOR Stationwagon	39LN95AGM			
E 320 4MATIC Stationwagon	39LN95AGM			
E 320 CDI Stationwagon	39LN95AGM			
E 250 CGI	39LN80AGM			
E 350 Blue Tec	39LN80AGM			
E 200 CGI Coupe	39LN80AGM			
E 250 CGI Coupe	39LN95AGM			
E 250 CGI Stationwagon	39LN80AGM			
E 300 Stationwagon	39LN80AGM			
E 350 Blue Tec Stationwagon	39LN80AGM			
230 GE	39LN95AGM			
G 550	39LN95AGM			
G 320	39LN95AGM			
300 GE	39LN95AGM			
G 320	39LN80AGM	39LN95AGM*		
G 500	39LN80AGM	39LN95AGM*		
G 55 AMG	39LN95AGM			
GL 550 4MATIC	39LN95AGM			
ML 550	39LN95AGM			
ML 500 4MATIC	39LN95AGM			
ML 63 AMG	39LN95AGM			
ML 350 4MATIC	39LN95AGM			
ML 350 Blue Tec 4MATIC	39LN95AGM			
R 63 AMG 4MATIC	39LN95AGM			
R 280	39LN95AGM			
R 350 4MATIC	39LN95AGM			
S 320	39LN95AGM			
S 430	39LN95AGM			
S 55 AMG	39LN95AGM			
S 600 M	39LN95AG			
S 350	39LN95AGM			
S 55 AMG KOMPRESSOR	39LN95AGM			
S 500	39LN95AGM			
S 430 4MATIC	39LN95AGM			

MERCEDES BENZ	ALTERNATIVA 1	ALTERNATIVA 2	ALTERNATIVA 3	OBSERVACIONES
S 600	39LN95AGM			
S 65 AMG	39LN95AGM			
S 550	39LN95AGM			
S 550 4MATIC	39LN95AGM			
S 63 AMG	39LN95AGM			
S 400 Hybrid	39LN95AGM			
SL 600	39LN70AGM			
SL 350	39LN70AGM			
SL 63 AMG	39LN70AGM			
SL 550	39LN70AGM			
SL 55 AMG	39LN70AGM			
SL 500	39LN70AGM			
SLK 200 KOMPRESSOR	39LN70AGM			
SLK 200	39LN70AGM			
SLR 5.4 Coupe 722 Edition	39LN70AGM			
SLR 5.4 Coupe	39LN70AGM			
SLR 5.4 Roadster	39LN70AGM			
Viano 3.2	39LN95AGM			
111 CDI Vito	39LN95AGM			
V 350	39LN95AGM			
MINI	ALTERNATIVA 1	ALTERNATIVA 2	ALTERNATIVA 3	OBSERVACIONES
Cooper Clubman	39LN70AGM			
Cooper S Clubman	39LN70AGM			
John Cooper Works Clubman	39LN70AGM			
One	39LN70AGM			
Cooper	39LN70AGM			
Cooper S	39LN70AGM			
John Cooper Works	39LN70AGM			
Cooper Convertible	39LN70AGM			
Cooper S Convertible	39LN70AGM			
John Cooper Works Convertible	39LN70AGM			
Cooper S Cabrio	39LN70AGM			
Cooper Cabrio	39LN70AGM			
Cooper S Countryman	39LN70AGM			
OPEL	ALTERNATIVA 1	ALTERNATIVA 2	ALTERNATIVA 3	OBSERVACIONES
Corsa	39LN60AMG			

PORSCHE	ALTERNATIVA 1	ALTERNATIVA 2	ALTERNATIVA 3	OBSERVACIONES
Cayenne 3.2	39LN95AGM			
Cayenne 3.6	39LN95AGM			
Cayenne 4.5 S	39LN95AGM			
Cayenne 4.5 Turbo	39LN95AGM			
Cayenne 4.8 S	39LN95AGM			
Cayenne 4.8 GTS	39LN95AGM			
Cayenne 4.8 Turbo	39LN95AGM			
Cayenne 4.8 Turbo S	39LN95AGM			
Cayenne 3.0 Hybrid	39LN95AGM			
Panamera 3.6	39LN95AGM			
Panamera 3.64	39LN95AGM			
Cayman 3.4 S	39LN70AGM			
911 3.8 Carrera S	39LN70AGM			

VOLVO	ALTERNATIVA 1	ALTERNATIVA 2	ALTERNATIVA 3	OBSERVACIONES
C30 2.0	39LN70AGM			
C70 II T5	39LN70AGM			
S40 II 2.4	39LN70AGM			
S60 II T4	39LN70AGM			
S80 II 2.5T	39LN70AGM			
V50 2.4i	39LN70AGM			
XC60 T6 AWD	39LN70AGM			
XC90 3.2 AWD	39LN70AGM			
XC90 T6 AWD	39LN70AGM			

VOLKSWAGEN	ALTERNATIVA 1	ALTERNATIVA 2	ALTERNATIVA 3	OBSERVACIONES
Golf V 3.2 R32 4Motion	39LN70AGM			
Passat 3.6 FSI R36 Variant 4Motion	39LN95AGM			
Passat 3.6 FSI 4Motion	39LN95AGM			
Sharan 1.4 TSI	39LN70AGM			
Caddy 1.9 TDI	39LN70AGM			
Caddy 2.0 SDI	39LN70AGM			
Eos 2.0 TSI	39LN70AGM			
Golf VI 1.4 TSI Cabrio	39LN70AGM			
Jetta 1.4 TSI	39LN70AGM			
Jetta 1.6	39LN70AGM			
Passat 1.8 TSI	39LN70AGM			
Passat 2.0 FSI	39LN70AGM			
Scirocco 1.4 TSI	39LN70AGM			
Touareg 3.2	39LN95AGM			

Aplicaciones baterías EFB

CITROËN	AÑO	ALTERNATIVA 1	ALTERNATIVA 2	OBSERVACIONES
CITROEN C3	2018	39EFB-60		
CITROEN C4	2018	39EFB-60		
MAZDA	AÑO	ALTERNATIVA 1	ALTERNATIVA 2	OBSERVACIONES
MAZDA 3	2017	39EFB-Q85L		
MAZDA CX-5	2016	39EFB-Q85L		
PEUGEOT	AÑO	ALTERNATIVA 1	ALTERNATIVA 2	OBSERVACIONES
PEUGEOT 208	2017	39EFB-60		
PEUGEOT 308	2017	39EFB-60		
PEUGEOT 508	2017	39EFB-70		
PEUGEOT 3008	2018	39EFB-70		
PEUGEOT 5008	2018	39EFB-70		
RENAULT	AÑO	ALTERNATIVA 1	ALTERNATIVA 2	OBSERVACIONES
CLIO	2018	39EFB-60		
MEGANE	2018	39EFB-60		
SUBARU	AÑO	ALTERNATIVA 1	ALTERNATIVA 2	OBSERVACIONES
NEW XV	2016	39EFB-Q85L		
VOLKSWAGEN	AÑO	ALTERNATIVA 1	ALTERNATIVA 2	OBSERVACIONES
GOLF	2015	39EFB-60		

Instalación de una batería Bosch

Para una correcta instalación de la batería es importante seguir ciertos pasos correctamente, así se podrá evitar futuros accidentes o daños ya sea en la batería o en el vehículo. A continuación se grafican los pasos a seguir:



1 DESCONECTAR EL TERMINAL NEGATIVO

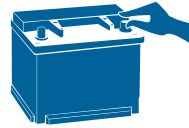

2 DESCONECTAR EL TERMINAL POSITIVO



3 REMOVER BATERÍA USADA



4 LIMPIAR BANDEJA Y TERMINALES



5 MONTAR BATERÍA



6 CONECTAR TERMINAL POSITIVO



7 FIJAR BATERÍA AL VEHÍCULO



8 CONECTAR TERMINAL NEGATIVO



9 CHEQUEAR SISTEMA ELECTRICO

Importante

Para prevenir que algunos accesorios como radio, alarma, cierre centralizado y otros se desprogramen, consultar el manual del vehículo antes de reemplazar la batería.

CATALOGO DE **COMMON RAIL**

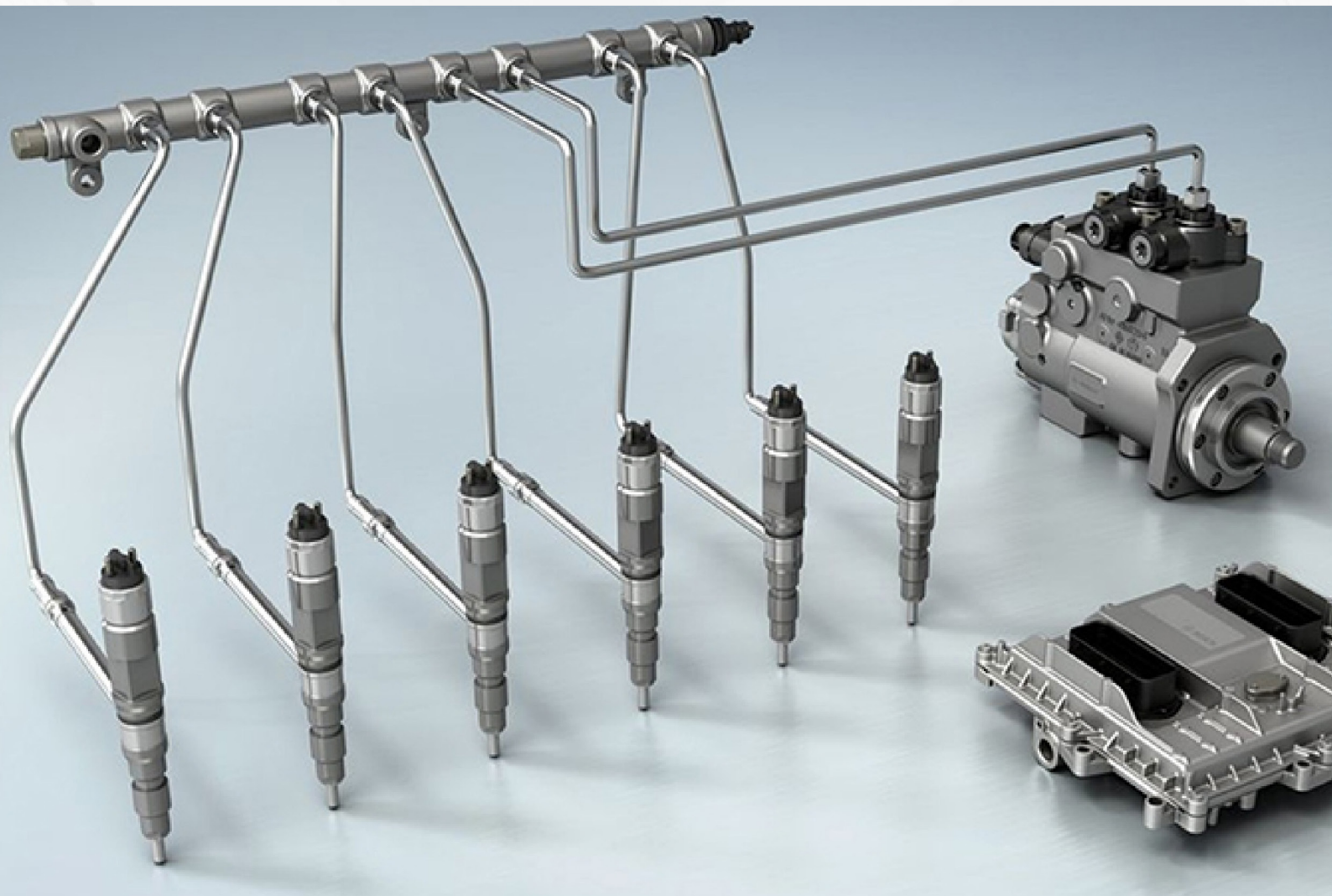

INDICE

INYECTORES CR

Inyectores Completos	04
Toberas	20
Juego de válvulas 3° Etapa	26
Esferas / Guías	32
Sellos / Empaquetaduras	32
Inducidos / Electroimanes	33
O´Rings	35
Cánulas	35
Juegos de Reparación	36
Tuercas	37
Arandelas de Calibración	38
Pernos de Presión	50
Varios	52

BOMBAS DE ALTA PRESION

Bombas Completas	54
Elementos	56
Culatas	56
Válvulas de Aspiración / Grupo Inyector	58
Juegos de Juntas	60
O´Rings, Juntas y Anillos	62
Ejes de mando / Arbol Excéntrico	64
Racord	65
Retenes	65
Bridas	66
Unidad Dosificadora (válvulas reguladoras de caudal)	68
Válvulas de Descarga	75
Varios	76
Válvulas Reguladoras de Presión (Bomba)	79

RAMPA DISTRIBUIDORA

Rampas Completas	80
Sensores de Presión	82
Válvulas Reguladoras de Presión (Rampa)	86
Válvulas Limitadoras de Presión	88

BOMBAS DE ENGRANAJES

Bombas de Engranajes	92
----------------------	----

BOMBAS UNITARIAS UPS

Bombas Unitarias UPS	94
Electroimanes	95
O´Rings	95
Juegos de Reparación	96
Resortes	97
Varios	97

INYECTORES PLD

Inyectores Completos	98
Toberas	100
Varios	100

SISTEMAS UIS / PDE

Inyectores PDE	102
Toberas	106
Tuercas Porta Toberas	107
Electroimanes	108
Juegos de Reparación	109
O´Rings	112
Varios	112





PERIFERICOS



Periféricos	114
-------------	-----



INYECTORES

INYECTORES COMPLETOS

Código Inyector	N° Tobera	3° Etapa	Aplicación	
Alfa Romeo				
0 445 110 002	0 433 175 175 (DSL A 145 P 763)	F00VC01016	Inyector Common Rail - A. Romeo 156 / 145 / 146 1.9JTD.	
0 445 110 111	0 433 171 771 (DLLA 148 P 1221)	F00VC01036	Inyector Common Rail - A. Romeo 147JTD 1.9 / 156 JTD 16v 1.9.	
0 445 110 183	0 433 171 889 (DLLA 150 P 1437)	F00VC01334	Inyector Common Rail - A. Romeo Mito 1.3 JTD.	
Audi				
0 445 110 065	0 433 175 290 (DSL A 160 P 1016)	F00VC01017	Inyector Common Rail - Audi A8 3.3 TDI Q Reemplaza 0445110113.	
0 445 115 078	Inyector completo	PIEZOELECTRICO	Inyector Common Rail - Common Rail - VW, Audi A4, A6, A8, Q7 3.0 TDI. Reemplaza a 0445 115 036.	

Código Inyector	N° Tobera	3° Etapa	Aplicación	
BMW				
0 445 110 266	0 433 171 616 (DLLA145 P 926)	F00VC01043	Inyector Common Rail - BMW 330D.	
0 445 110 131	0 433 171 690 (DLLA 160 P 1063)	F00VC01310	Inyector Common Rail - BMW 320 Cd Cabrio / 330d / 330xd.	
0 445 115 070	Inyector completo	PIEZOELECTRICO	Inyector Common Rail - BMW 350, 530, 730, X3, X5.	
0 445 116 001	Inyector completo	PIEZOELENTRICO	Inyector Common Rail - BMW 320D Active X3 / X520D.	
Chevrolet				
0 445 110 083	0433171774 (DLLA 150 P 1224)	F00VC01038	Inyector Common Rail Chevrolet Combo 1.3 Cdti.	
0 445 110 231	0 433 171 693 (DLLA 148 P 1067)	F00VC01023	Inyector Common Rail - Chevrolet Blazer 2.8 Diesel Electronic / S10 2.8 D. E - Nissan Frontier 2.8 Diesel Electronic / Xterra 2.8 - VW 5.140 E.	
0 445 110 354	0433172135 (DLLA 145 P 2135)	F00VC01379	Inyector Common Rail - Nueva Chevrolet S10 2.8 CTDI	

INYECTORES COMPLETOS

Código Inyector	N° Tobera	3° Etapa	Aplicación	
Chrysler				
0 445 110 059	0 433 171 641 (DLLA 145 P 978)	F00VC01015	Inyector Common Rail - Chrysler Voyager 2.5 / 2.8 CRD. Jeep, Cherokee.	
Citroën				
0 445 110 044	0 433 175 196 (DSL A 142 P 795)	F00VC01003	Inyector Common Rail - Citroën Ber- lingo Mot. M49 / Jumpi Mot. U64 / Xantia Mot. X2 2.0 HDI - Peugeot 206 2.0 HDI Mot. T1 - Expert 2.0 HDI Mot. U64 - Suzuki Grand Vitara 2.0 Tdi diesel turbo.	
0 445 110 057	0 433 175 272 (DSL A 144 P 971)	F00VC01013	Inyector Common Rail - Citroën 2.0 HDI / Jumpy 2.0 HDI - Peu- geot 806 2.0 HDI / 807 2.0 HDI / Expert 2.0 HDI.	
0 445 110 062	0 433 175 281 (DSL A 142 P 988)	F00VC01003	Inyector Common Rail - Citroën Berlingo 2.0HDI / C5 2.0HDI / Jumpy 2.0 HDI - Peugeot 307 2.0 HDI.	
0 445 110 076	0 433 175 431 (DSL A 142 P 1474)	F00VC01053	Inyector Common Rail - Citroën C5 2.0HDI - Jumper 2.0 HDI - Fiat Ducato 11 2.0 JTD - Peugeot 206 / 307 / 406 / Boxer / Expert 2.0 HDI.	
0 445 110 135	0 433 175 308 (DSL A 146 P 1055)	F00VC01303	Inyector Common Rail - Citroën C3 1.4 HDI / Xsara 1.4 HDI - Peugeot 206 1.4 HDI / 16v / 307 1.4HDI.	
0 445 110 188	0 433 171 853 (DLLA 150 P 1373)	F00VC01315	Inyector Common Rail - Citroën C4 1.6 HDI / C5 1.6 HDI / Xsara Picasso 1.6 HDI - Ford Focus 1.6 TDCI - Peu- geot 407 / 1.6 HDI / 307 1.6 HDI.	
0 445 110 239	0 433 171 914 (DLLA 150 P 1471)	F00VC01315	Inyector Common Rail - Citroën Ber- lingo 1.6 HDI / C3 1.6 HDI / C4 1.6 HDI / Xsara Picasso 1.6 HDI - Ford Fiesta 1.6 TDCI / Focus 1.6 TDCI - Peugeot 207 1.6 HDI / 307 1.6 HDI / Expert 1.6 HDI / Partner 1.6 HDI.	

Código Inyector	N° Tobera	3° Etapa	Aplicación	
0 445 110 252	0 433 171 944 (DLLA 143 P 1532)	F00VC01342	Inyector Common Rail - Citroën C3 1.4HDI - Peugeot 206 1.4 HDI / 207 1.4 HDI.	
0 445 120 002	0 433 175 203 (DSL A 136 P 804)	F00RJ00005	Inyector Common Rail - Citroën Jumper 2.8 HDI - Fiat Ducato 10 / 11 / 14 / 15 / 18 2.8 JTD - Iveco Daily 29 L13 / 9 / Daily 35 C11 / 13 / 15 - Peugeot Boxer 2.8 HDI.	
Cummins				
0 445 120 125	0433172040 (DLLA 118 P 1697)	F00RJ01941	Inyector Common Rail - Ford Cargo 1832 - Renault.	
0 445 120 133	0433172051 (DLLA 145 P 1714)	F00RJ01941	Inyector Common Rail - Cummins.	
0 445 120 208	0 433 175 500 (DSL A 124 P 5500)	F00RJ02130	Inyector Common Rail - Cummins. Reemplazado x 0445120238	
0 445 120 210	0433175499 (DSL A 143 P 5499)	F00RJ02130	Inyector Common Rail - Cummins. Reemplazado x 0445120255	
0 445 120 231	0433175510 (DSL A 128 P 5510)	F00RJ02130	Inyector Common Rail - Cummins - Reemplaza a 0445120059	
0 445 120 238	0433175516 (DSL A 124 P 5516)	F00RJ02130	Inyector Common Rail - Motor Cummins.	
0 445 120 250	0433175517 (DSL A 143 P 5517)	F00RJ02130	Inyector Common Rail Cummins Komatsu PC220-8 - 503. Reemplaza a 0445120060	

INYECTORES COMPLETOS

Código Inyector	N° Tobera	3° Etapa	Aplicación	
Deutz				
0 445 120 043	0 433 171 870 (DLLA 143 P 1404)	F00RJ02067	Inyector Common Rail - Agrale Deutz 8500E-Tronic - Marco Polo Volare W8 Electrónico - VW 15.180 / 15.190 / 17.210 / 17.230 EOD Electrónico. Reemplazado x 0445120326	
0 445 120 067	0 433 171 698 (DLLA 152 P 1075)	F00RJ01479	Inyector Common Rail - Deutz SD2012 L.	
0 445 120 326	No disponible	No disponible	Inyector Common Rail - Agrale Deutz con MWM 4.8. Reemplaza a 0445120043.	
0 445 120 340	No disponible	No disponible	Inyector Common Rail - Agro (Deutz, Allis) Reemplaza a 0445120063.	
Fiat				
0 445 110 002	0 433 175 175 (DSL A 145 P 763)	F00VC01016	Inyector Common Rail - Fiat Bravo, Marea, 1.9 JTD.	
0 445 110 076	0 433 175 431 (DSL A 142 P 1474)	F00VC01053	Inyector Common Rail - Fiat Ducato 11 2.0 JTD - Citroën C5 2.0HDI - Jumper 2.0 HDI - Peugeot 206 / 307 / 406 / Boxer / Expert 2.0 HDI.	
0 445 110 111	0 433 171 771 (DLLA 148 P 1221)	F00VC01036	Inyector Common Rail - Fiat Stilo 1.9 JTD 16v - A. Romeo 147JTD 1.9 / 156 JTD 16v 1.9.	
0 445 110 183	0 433 171 889 (DLLA 150 P 1437)	F00VC01334	Inyector Common Rail - Fiat Idea 1.3JTD16v / Punto Evo1.3 JTD / MJTD. - A. Romeo Mito 1.3 JTD.	
0 445 110 248	0433171945 DLLA 138 P 1533	F00VC01338	Inyector Common Rail - Fiat Ducato Motor JTD Iveco Daily 35/40/45/50CC.	

Código Inyector	N° Tobera	3° Etapa	Aplicación	
0 445 110 682			Inyector Common Rail - Fiat Toro	
0 445 120 002	0 433 175 203 (DSLA 136 P 804)	F00RJ00005	Inyector Common Rail - Fiat Ducato 10 / 11 / 14 / 15 / 18 2.8 JTD - Iveco Daily 29 L13 / 9 / Daily 35 C11 / 13 / 15 - Citroën Jumper 2.8 HDI - Peugeot Boxer 2.8 HDI.	
Ford				
0 445 110 136	0 433 171 801 (DLLA 150 P 1274)	F00VC01315	Inyector Common Rail - Ford Focus C-MAX 1.6 TDCI.	
0 445 110 188	0 433 171 853 (DLLA 150 P 1373)	F00VC01315	Inyector Common Rail - Ford Focus 1.6 TDCI - Citroën C4 1.6 HDI / C5 1.6 HDI / Xsara Picasso 1.6 HDI - Peugeot 407 / 1.6 HDI / 307 1.6 HDI.	
0 445 110 239	0 433 171 914 (DLLA 150 P 1471)	F00VC01315	Inyector Common Rail - Ford Fiesta 1.6 TDCI / Focus 1.6 TDCI - Citroën Berlingo 1.6 HDI / C3 1.6 HDI / C4 1.6 HDI / Xsara Picasso 1.6 HDI - Peugeot 207 1.6 HDI / 307 1.6 HDI / Expert 1.6 HDI / Partner 1.6 HDI.	
0 445 120 120	0 433 172 037 (DLLA 118 P 1691)	F00RJ01941	Inyector Common Rail - Ford Cargo C 2632 / 2932 / 4432 / E - VW 18.320 EOT / Constelación 19.320 Titan.	
0 445 120 212	0433175501 (DSLA 143 P 5501)	F00RJ02130	Inyector Common Rail - Ford Cargo C1317-15-17-1717-1712-2422- VW8150 Common Rail	
0 445 120 236	0433172203 (DLLA 118 P 2203)	F00RJ01941	Inyector Common Rail - Ford Cargo 1832. Motor Cummins.	

INYECTORES COMPLETOS

Código Inyector	N° Tobera	3° Etapa	Aplicación	
0 445 120 273	0433175540 (DSL A 143P 5540)	F00RJ02130	Inyector Common Rail - Ford Cargo C1717, C1722, F250, Iveco Euro-cargo, VW Worker, Motor Cummins.	
Hyundai				
0 445 110 092	0 433 171 719 (DLLA 156 P 1114)	F00VC01033	Inyector Common Rail - Hyundai H1 2.5 CRDI.	
0 445 110 186	0 433 171 848 (DLLA 156 P 1368)	F00VC01033	Inyector Common Rail - Hyundai	
0 445 110 253	0433171933 DLLA 150 P 1512	F00VC01346	Inyector Hyundai Sta. Fe 2.2 Common Rail	
0 445 110 290	0 433 171 755 (DLLA 150 P 1197)	F00VC01044	Inyector Common Rail - Hyundai Sta. Fe 2.0 CRDI - Kia Sportage New 2.0 CRDI.	
Iveco				
0 445 110 248	0433171945 DLLA 138 P 1533	F00VC01338	Inyector Common Rail - Iveco Daily 35/40/45/50CC - Fiat Ducato Motor JTD	
0 445 116 059			Inyector Common Rail - Iveco Daily Nuevo 55 C 17 /70 C 17 3.0 17 3.0	
0 445 120 002	0 433 175 203 (DSL A 136 P 804)	F00RJ00005	Inyector Common Rail - Iveco Daily 29 L13 / 9 / Daily 35 C11 / 13 / 15 - Citroën Jumper 2.8 HDI - Fiat Ducato 10 / 11 / 14 / 15 / 18 2.8 JTD - Peugeot Boxer 2.8 HDI.	

Código Inyector	N° Tobera	3° Etapa	Aplicación	
0 445 120 007	0 433 175 271 (DSLAL 143 P 970)	F00RJ0339	Inyector Common Rail - Iveco 170 E25 (T) 240E25 (S) - Eurocargo 100 E17 / 18.	
0 445 120 028	0433171827 (DLLA 142 P 1333)	F00RJ01052	Inyector motor Marino Iveco N50	
0 445 120 054	0433171947 (DLLA 143 P 1536)	F00RJ01278	Inyector Common Rail Iveco, Eurocargo, 170E, 240E, 260E	
0 445 120 273	0433175540 (DSLAL 143P 5540)	F00RJ02130	Inyector Common Rail - Iveco Eurocargo, VW Worker, Motor Cummins-Ford Cargo C1717, C1722, F250.	
Jeep				
0 445 110 189	0 433 175 395 (DSLAL 154 P 1320)	F00VC01051	Inyector Common Rail - Jeep Grand Cherokee 2.7 CRD - M. Benz 208 / 211 / 213 / 216 / 308 / 311 / 313 / 316 / 408 / 411 / 413 / 416 DCI Sprinter.	
0 445 110 218	0433171888 (DLLA 145 P 1430)	F00VC01333	Inyector Common Rail - Jeep Cherokee 2.5-2.8 4X4	
0 445 110 260	0 433 171 940 (DLLA 152 P 1525)	F00VC01334	Inyector Common Rail - Jeep Mahindra - Scorpio Pick-up 2.6 CRDE.	
0 445 115 067	Inyector completo	PIEZOELECTRICO	Inyector Common Rail - Jeep Cherokee 2.8 CRD	
Kia				

INYECTORES COMPLETOS

Código Inyector	N° Tobera	3° Etapa	Aplicación	
0 445 110 274	0433171982 (DLLA 153 P 1608)	F00VC01352	Inyector Common Rail Kia Sorento 2.8 C.R.	
0 445 110 290	0 433 171 755 (DLLA 150 P 1197)	F00VC01044	Inyector Common Rail - Kia Sportage New 2.0 CRDI - Hyundai Sta. Fe 2.0 CRDI.	
Land Rover				
0 445 110 049	0 433 171 618 (DLLA 145 P 928)	F00VC01043	Inyector Common Rail - Land Rover Freelander I 2.0 Td4.	
0 445 110 130	0433171773 DLLA 145 P 1223	F00VC01043	Inyector Common Rail - Land Rover Freelander motor BMW	
0 445 115 042	Inyector completo	PIEZOELECTRICO	Inyector Common Rail - Land Rover Freelander II 2.2 Td4.	
Mercedes Benz				
0 445 110 011	0433175163 (DSL A 156 P 736)	F00VC01001	Inyector Common Rail - M. Benz 108 - 110 - 112 CDI Vito	
0 445 110 024	0 433 175 163 (DSL A 156 P 736)	F00VC01001	Inyector Common Rail - M. Benz Sprinter DCI 208 (OM611.987DeLA) / 211 (OM611.981DeLA) / 213 (OM611.981DeLA) / 216 (OM612.981DeLA) / 308 (OM611.987DeLA) / 311 / 313 / 316	

Código Inyector	N° Tobera	3° Etapa	Aplicación	
0 445 110 054	0 433 175 314 (DSL A 156 P 1079)	F00VC01309	Inyector Common Rail - M. Benz E 200 / 220 / 270 DCI C / motor OM 646,951 / 961. Reemplaza a 0986435095.	
0 445 110 069	0 433 175 298 (DSL A 154 P 1034)	F00VC01001	Inyector Common Rail - M. Benz 208 / 211 / 213 / 216 / 308 / 311 / 313 / 316 / 408 / 411 / 413 / DCI Sprinter.	
0 445 110 071	0 433 175 163 (DSL A 156 P 736)	F00VC01001	Inyector Common Rail - M. Benz. C 200DCI / E200 DCI.	
0 445 110 095	0 433 171 712 (DLL A 156 P 1107)	F00VC01045	Inyector Common Rail - M. Benz 211 / 213 / 216 / 316 / 311 / 313 DCI Sprinter / E320.	
0 445 110 099	0 433 175 326 (DSL A 156 P 1113)	F00VC01045	Inyector Common Rail - M. Benz C 200 DCI T-Modell / 220 DCI / E 200 / 220 DCI.	
0 445 110 107	0 433 175 395 (DSL A 154 P 1320)	F00VC01045	Inyector Common Rail - M. Benz 208 / 211 / 213 / 216 / 308 / 311 / 313 / 316 / 408 / 411 / 416 DCI Sprinter.	
0 445 110 120	0 433 171 712 (DLL A 156 P 1107)	F00VC01045	Inyector Common Rail - M. Benz C270 DCI / C270 DCI T.Modell / CLK 270 DCI Coupe. Reemplazado x 0 445 110 205	
0 445 110 176	0 433 171 800 (DLL A153 P 1270)	F00VC01328	Inyector Common Rail - M. Benz C200 / 220 / 270 / 280 / 320 DCI.	

INYECTORES COMPLETOS

Código Inyector	N° Tobera	3° Etapa	Aplicación	
0 445 110 189	0 433 175 395 (DSL A 154 P 1320)	F00VC01051	Inyector Common Rail - M. Benz 208 / 211 / 213 / 216 / 308 / 311 / 313 / 316 / 408 / 411 / 413 / 416 DCI Sprinter Jeep Grand Cherokee 2.7 CRD.	
0 445 110 201	0 433 171 712 (DLA 156 P 1107)	F00VC01051	Inyector Common Rail - M. Benz. 108 DCI Vito / 110 / 112.	
0 445 110 203	0 433 171 718 (DLA 156 P 1111)	F00VC01054	Inyector Common Rail - M. Benz 208 / 211 / 213 / 216 / 308 / 311 / 313 / 316 / 408 / 411 / 416 DCI Sprinter.	
Mercedes Benz				
0 445 110 205	0 433 171 913 (DLA 156 P 1473)	F00VC01051	Inyector Common Rail - M. Benz C200, 220, 270, E200, E220, E270. Reemplaza a 0 445 110 120	
0 445 115 063	Inyector completo	PIEZOELECTRICO	Inyector Common Rail - M. Benz 218 / 318 / 418 / 518 DCI Sprinter - C 320 DCI - E 280 / 320 DCI - Viano DCI 3.0.	
New Holland				
0 445 120 057	0 433 175 456 (DSL A 143 P 1535)	F00RJ01278	Inyector Common Rail - New Holland 93W - W 170B / 190B.	
0 445 120 075	0 433 171 966 (DLA 137 P 1577)	F00RJ01278	Inyector Common Rail - Cosechadora New Holland, Case 211 con motor 667.	
0 445 120 092	0 433 172 011 (DLA 137 P 1648)	F00RJ01819	Inyector Common Rail - Cosechadora New Holland CR9060.	

Código Inyector	N° Tobera	3° Etapa	Aplicación	
Nissan				
0 445 110 110	0 433 175 337 (DSLA 140 P 1142)	F00VC01034	Inyector Common Rail - Nissan InterstarTurbo DCI80 - Renault Megane 1.9 DCI / Master 1.9 DCI80.	
0 445 110 141	0 433 171 811 (DLLA 146 P 1296)	F00VC01022	Inyector Common Rail - Nissan Interstar 2.5 Diesel Turbo DCI 100 - Renault Master 2.5 DCI100.	
0 445 110 231	0 433 171 693 (DLLA 148 P 1067)	F00VC01023	Inyector Common Rail - Nissan Frontier 2.8 Diesel Electronic / Xterra 2.8 -VW 5.140 E - Chevrolet Blazer 2.8 Diesel Electronic / S10 2.8 D. E.	
0 445 110 336			Inyector Common Rail Nissan Fron- tier - Xterra 2.8	
Peugeot				
0 445 110 044	0 433 175 196 (DSLA 142 P 795)	F00VC01003	Inyector Common Rail - Peugeot 206 2.0 HDI Mot. T1 - Expert 2.0 HDI Mot. U64 - Citroën Berlingo Mot. M49 / Jumpi Mot. U64 / Xantia Mot. X2 2.0 HDI - Suzuki Grand Vitara 2.0 Tdi diesel turbo.	
0 445 110 057	0 433 175 272 (DSLA 144 P 971)	F00VC01013	Inyector Common Rail - Peugeot 806 2.0 HDI / 807 2.0 HDI / Expert 2.0 HDI - Citroën 2.0 HDI / Jumpy 2.0 HDI.	
0 445 110 062	0 433 175 281 (DSLA 142 P 988)	F00VC01003	Inyector Common Rail - Peugeot 307 2.0 HDI - Citroën Berlingo 2.0HDI / C5 2.0HDI / Jumpy 2.0 HDI.	
0 445 110 076	0 433 175 431 (DSLA 142 P 1474)	F00VC01053	Inyector Common Rail - Peugeot 206 / 307 / 406 / Boxer / Expert 2.0 HDI - Citroën C5 2.0HDI - Jumper 2.0 HDI - Fiat Ducato 11 2.0 JTD.	

INYECTORES COMPLETOS







Código Inyector	N° Tobera	3° Etapa	Aplicación	
0 445 110 135	0 433 175 308 (DSLA 146 P 1055)	F00VC01303	Inyector Common Rail - Peugeot 206 1.4 HDI / 16v / 307 1.4HDI - Citroën C3 1.4 HDI / Xsara 1.4 HDI.	
0 445 110 188	0 433 171 853 (DLLA 150 P 1373)	F00VC01315	Inyector Common Rail - Peugeot 407 / 1.6 HDI / 307 1.6 HDI - Citroën C4 1.6 HDI / C5 1.6 HDI / Xsara Picasso 1.6 HDI - Ford Focus 1.6 TDCI.	
0 445 110 239	0 433 171 914 (DLLA 150 P 1471)	F00VC01315	Inyector Common Rail - Peugeot 207 1.6 HDI / 307 1.6 HDI / Expert 1.6 HDI / Partner 1.6 HDI - Citroën Berlingo 1.6 HDI / C3 1.6 HDI / C4 1.6 HDI / Xsara Picasso 1.6 HDI - Ford Fiesta 1.6 TDCI / Focus 1.6 TDCI.	
0 445 110 252	0 433 171 944 (DLLA 143 P 1532)	F00VC01342	Inyector Common Rail - Peugeot 206 1.4 HDI / 207 1.4 HDI - Citroën C3 1.4HDI.	
0 445 110 273			Inyector Common Rail - Peugeot Boxer / Ducato / Daily / Jumper 2.3	
0 445 120 002	0 433 175 203 (DSLA 136 P 804)	F00RJ00005	Inyector Common Rail - Peugeot Boxer 2.8 HDI - Citroën Jumper 2.8 HDI - Fiat Ducato 10 / 11 / 14 / 15 / 18 2.8 JTD - Iveco Daily 29 L13 / 9 / Daily 35 C11 / 13 / 15.	
Renault				
0 445 110 110	0 433 175 337 (DSLA 140 P 1142)	F00VC01034	Inyector Common Rail - Renault Megane 1.9 DCI / Master 1.9 DCI80 - Nissan InterstarTurbo DCI80.	
0 445 110 141	0 433 171 811 (DLLA 146 P 1296)	F00VC01022	Inyector Common Rail - Renault Master 2.5 DCI100 - Nissan Interstar 2.5 Diesel Turbo DCI 100.	
0 445 110 146	0 433 175 230 (DSLA 140 P 862)	F00VC01005	Inyector Common Rail - Renault Laguna II 1.9 DCI - Master 1.9 DCI 80 - Scenic 1.9 DCI.	

Código Inyector	N° Tobera	3° Etapa	Aplicación	
0 445 110 265	0433171960 DLLA 150 P 1557	F00VC01353	Inyector Common Rail - Renault Master 2,5.	
0 445 110 375	0 433 172 147 (DLLA 150P 2147)	F 00V C01 380	Inyector Common Rail - Renault Master 2.3 DCI	
0 445 120 003	0 433 171 562 (DLLA 155 P 822)	F00RJ00218	Inyector Common Rail - Renault 420 Premium Route.	
0 445 120 012	0 433 171 681 (DLLA 144 P 1050)	F00RJ02067	Inyector Common Rail - Renault 210 Midlum / 220 4x2 Midlum / 220 Premium.	
0 445 120 014	0 433 171 683 (DLLA 155 P 1052)	F00RJ00399	Inyector Common Rail - Renault Premium 320 DCI.	
0 445 120 019	0 433 171 699 (DLLA 150 P 1076)	F00RJ00399	Inyector Common Rail - Renault 420.	
0 445 120 074	0433171965 DLLA 156 P 1566	F00RJ01451	Inyector Common Rail - Renault Midlum, Premium II Volvo.	
Sisu				
0 445 120 062	0433171962 DLLA 152 P 1563	F00RJ01522	Inyector Sistema Common Rail - Sisu.	

INYECTORES COMPLETOS

Código Inyector	N° Tobera	3° Etapa	Aplicación	
0 445 120 063	0 433 171 961 (DLLA 149 P 1562)	F00RJ01533	Inyector Common Rail - Sisu 74 / 84. Reemplazado x 0445120340	
0 445 120 340	No disponible	No disponible	Inyector Common Rail - Agro (Deutz, Allis) Reemplaza a 0445120063	
Suzuki				
0 445 110 044	0 433 175 196 (DSL A 142 P 795)	F00VC01003	Inyector Common Rail - Suzuki Grand Vitara 2.0 Tdi diesel turbo - Citroën Berlingo Mot. M49 / Jumpi Mot. U64 / Xantia Mot. X2 2.0 HDI - Peugeot 206 2.0 HDI Mot. T1 - Expert 2.0 HDI Mot. U64.	
Volkswagen				
0 445 110 231	0 433 171 693 (DLLA 148 P 1067)	F00VC01023	Inyector Common Rail - VW 5.140 E, Delivery 3.0/ 4.8 TCE.	
0 445 110 646	No disponible	No disponible	Inyector Common Rail - VW Amarok 2.0, Beetle 2.0	
0 445 115 078	Inyector completo	PIEZOELECTRICO	Inyector Common Rail - Common Rail - VW, Audi A4, A6, A8, Q7 3.0 TDI. Reemplaza a 0445 115 036.	
0 445 116 034	Inyector completo	PIEZOELECTRICO	Inyector Common Rail - VW Amarok 2.0 TDI -Transporter T5 2.0 TDI.	
Volkswagen				
0 445 120 043	0 433 171 870 (DLLA 143 P 1404)	F00RJ02067	Inyector Common Rail - VW 15.180 / 15.190 / 17.210 / 17.230 EOD Eléctronico - Agrale Deutz 8500E-Tronic - Marco Polo Volare W8 Eléctronico. Reemplazado x 0445120326	

Código Inyector	N° Tobera	3° Etapa	Aplicación	
0 445 120 089	0 433 171 988 (DLLA 143 P 1619)	F00RJ02067	Inyector Common Rail - VW Constellation 13.180 / 15.180 / 26.260 / 31.260 / Volvo 1265 VM210 / 1237 VM260 / 1236 VM310. Reemplazado x 0445120330	
0 445 120 120	0 433 172 037 (DLLA 118 P 1691)	F00RJ01941	Inyector Common Rail - VW 18.320 EOT / Constellation 19.320 Titan - Ford Cargo C 2632 / 2932 / 4432 / E.	
0 445 120 140	0 433 172 083 (DLLA 126 P 1776)	F00RJ01941	Inyector Common Rail - VW 18.320 EOT - Constellation 19.320 Titan / 25.320 / 31.320.	
0 445 120 212	0433175501 (DSLA 143 P 5501)	F00RJ02130	Inyector Common Rail - VW8150 - Ford Cargo C1317-15-17-1717-1712-2422-VW8150.	
0 445 120 273	0433175540 (DSLA 143P 5540)	F00RJ02130	Inyector Common Rail - VW Worker, Motor Cummins - Ford Cargo C1717, C1722, F250, Iveco Eurocargo.	
0 445 120 326	No disponible	No disponible	Inyector Common Rail - VW 15.180 / 15.190 / 17.210 / 17.230 EOD Electrónico - Agrale Deutz con MWM 4.8. Reemplaza a 0445120043.	
0 445 120 330	No disponible	No disponible	Inyector Common Rail - VW Constellation 13.180 / 15.180 / 26.260 / 31.260 / Volvo 1265 VM210 / 1237 VM260 / 1236 VM310. MWM, Volvo. Reemplaza a 0445120089	
Volvo				
0 445 110 078	0433175310 (DSLA 140 P 1061)	F00VC01301	Inyector Common Rail - Volvo S60.2.4/S80/VT70II/XC70/XC90	

Código Inyector	N° Tobera	3° Etapa	Aplicación	
0 445 110 251	0 433 171 923 DLLA 139P 1497	F00VC01345	Inyector Common Rail - Volvo C30, C70, S60, XC70, XC90.	
0 445 120 066	0 433 171 964 (DLLA 145 P 1068)	F00RJ01479	Inyector Common Rail - Volvo G900 con motor D7D Orig - 04290986-5.	
0 445 120 074	0433171965 DLLA 156 P 1566	F00RJ01451	Inyector Common Rail Renault Midlum/Premium II Volvo	
0 445 120 089	0 433 171 988 (DLLA 143 P 1619)	F00RJ02067	Inyector Common Rail - VW Constellation 13.180 / 15.180 / 26.260 / 31.260 / Volvo 1265 VM210 / 1237 VM260 / 1236 VM310. Reemplazado x 0445120330	
0 445 120 173	0433172109 (DLLA 150 P 1817)	F00RJ01222	Inyector Sistema Common Rail - Volvo Penta.	
0 445 120 330	No disponible	No disponible	Inyector Common Rail - Volvo con motor MWM, VW Constellation 13.180 / 15.180 / 26.260 / 31.260 / Volvo 1265 VM210 / 1237 VM260 / 1236 VM310. MWM. Reemplaza a 0445120089	

DESPIECE DE INYECTORES | TOBERAS

N° Tobera	Código Inyector	3° Etapa	Aplicación
0 433 171 562 (DLLA 155 P 822)	0 445 120 003	F00RJ00218	Inyector Common Rail - Renault 420 Premium Route.
0 433 171 594 (DLLA 156P889)	0445110034	F00VC01001	Inyector Common Rail - M. Benz Sprinter 311
0 433 171 616 (DLLA145 P 926)	0 445 110 266	F00VC01043	Inyector Common Rail - BMW 330D.
0 433 171 618 (DLLA 145 P 928)	0 445 110 049	F00VC01043	Inyector Common Rail - Land Roverd Freelander I 2.0 Td4.
0 433 171 641 (DLLA 145 P 978)	0 445 110 059	F00VC01015	Inyector Common Rail - Chrysler Voyager 2.5 / 2.8 CRD.
0 433 171 681 (DLLA 144 P 1050)	0 445 120 012	F00RJ02067	Inyector Common Rail - Renault 210 Midlum / 220 4x2 Midlum / 220 Premium.
0 433 171 683 (DLLA 155 P 1052)	0 445 120 014	F00RJ00399	Inyector Common Rail - Renault Premium 320 DCI.
0 433 171 690 (DLLA 160 P 1063)	0 445 110 131	F00VC01310	Inyector Common Rail - M. Benz 320 Cd Cabrio / 330d / 330xd.
0 433 171 693 (DLLA 148 P 1067)	0 445 110 231	F00VC01023	Inyector Common Rail - Chevrolet Blazer 2.8 Diesel Electronic / S10 2.8 D. E - Nissan Frontier 2.8 Diesel Electronic / Xterra 2.8 - VW 5.140 E.
0 433 171 698 (DLLA 152 P 1075)	0 445 120 067	F00RJ01479	Inyector Common Rail - Deutz SD2012 L.
0 433 171 699 (DLLA 150 P 1076)	0 445 120 019	F00RJ00399	Inyector Common Rail - Renault 420.
	0 445 110 095	F00VC01045	Inyector Common Rail - M. Benz 211 / 213 / 216 / 316 / 311 / 313 DCI Sprinter / E320.
0 433 171 712 (DLLA 156 P 1107)	0 445 110 120	F00VC01045	Inyector Common Rail - M. Benz C270 DCI / C270 DCI T.Modell / CLK 270 DCI Coupe.
	0 445 110 201	F00VC01051	Inyector Common Rail - M. Benz. 108 DCI Vito / 110 / 112.
0 433 171 718 (DLLA 156 P 1111)	0 445 110 203	F00VC01054	Inyector Common Rail - M. Benz 208 / 211 / 213 / 216 / 308 / 311 / 313 / 316 / 408 / 411 / 416 DCI Sprinter.
0 433 171 719 (DLLA 156 P 1114)	0 445 110 092	F00VC01033	Inyector Common Rail - Hyunday H1 2.5 CRDI.

N° Tobera	Código Inyector	3° Etapa	Aplicación
0 433 171 755 (DLLA 150 P 1197)	0 445 110 290	F00VC01044	Inyector Common Rail - Hyundai Sta. Fe 2.0 CRDI - Kia Sportage New 2.0 CRDI.
0 433 171 771 (DLLA 148 P 1221)	0 445 110 111	F00VC01036	Inyector Common Rail - A. Romeo 147JTD 1.9 / 156 JTD 16v 1.9 - Fiat Stilo 1.9 JTD 16v.
0 433 171 773 (DLLA 145 P 1223)	0 445 110 130	F00VC01043	Inyector Common Rail - BMW.
0 433 171 774 (DLLA 150 P 1224)	0 445 110 083	F00VC01038	Inyector Common Rail - Chevrolet combo 1.3 CDTI c/mot Isuzu .
0 433 171 800 (LLA153 P 1270)	0 445 110 176	F00VC01328	Inyector Common Rail - M. Benz C200 / 220 / 270 / 280 / 320 DCI.
0 433 171 801 (DLLA 150 P 1274)	0 445 110 136	F00VC01315	nyector Common Rail - Focus C-MAX 1.6 TDCI.
0 433 171 811 (DLLA 146 P 1296)	0 445 110 141	F00VC01022	Inyector Common Rail - Nissan Interstar 2.5 Diesel Turbo DCI 100 - Renault Master 2.5 DCI100.
0 433 171 827 (DLLA 142 P 1333)	0 445 120 028	F00RJ01052	Inyector Common Rail - Motor marino Iveco n50.
0 433 171 843 (DLLA118P 1357)	0 445 120 029	F00RJ01941	Inyector Common Rail - Motor Cummins
0 433 171 848 (DLLA 156 P 1368)	0 445 110 186	F00VC01033	Inyector Common Rail - Kia Sorento 2.5.
0 433 171 853 (DLLA 150 P 1373)	0 445 110 188	F00VC01315	Inyector Common Rail - Citroën C4 1.6 HDI / C5 1.6 HDI / Xsara Picaso 1.6 HDI - Ford Focus 1.6 TDCI - Peugeot 407 / 1.6 HDI / 307 1.6 HDI.
0 433 171 862 (DLLA 144P 1387)	0 445 120 037	F00RJ01941	Inyector Common Rail - Dodge Ram c/bomba UP44.
0 433 171 870 (DLLA 143 P 1404)	0 445 120 043	F00RJ02067	Inyector Common Rail - Agrale Deutz 8500E-Tronic - Marco Polo Volare W8 Eléctronico - VW 15.180 / 15.190 / 17.210 / 17.230 EOD Eléctronico.
0 433 171 888 (DLLA 145 P 1430)	0 445 110 218	F00VC01333	Inyector Common Rail - Cherokee 2.5-2.8 4X4.
0 433 171 889 (DLLA 150 P 1437)	0 445 110 183	F00VC01334	Inyector Common Rail - A. Romeo Mito 1.3 JTD - Fiat Idea 1.3JTD16v / Punto Evo1.3 JTD / MJTD.
0 433 171 910 (DLLA150P1467)	0 445 120 051	F00RJ01222	Inyector Volvo Penta N° Original 3587680

DESPIECE DE INYECTORES | TOBERAS

N° Tobera	Código Inyector	3° Etapa	Aplicación
0 433 171 914 (DLLA 150 P 1471)	0 445 110 239	F00VC01315	Inyector Common Rail - Citroën Berlingo 1.6 HDI / C3 1.6 HDI / C4 1.6 HDI / Xsara Picasso 1.6 HDI - Ford Fiesta 1.6 TDCI / Focus 1.6 TDCI - Peugeot 207 1.6 HDI / 307 1.6 HDI / Expert 1.6 HDI / Partner 1.6 HDI.
0 433 171 933 (DLLA 150 P 1512)	0 445 110 253	F00VC01346	Inyector Common Rail - Hyundai Santa Fe 2.2.
0 433 171 940 (DLLA 152 P 1525)	0 445 110 260	F00VC01334	Inyector Common Rail - Scorpio Pick-up 2.6 CRDe.
0 433 171 944 (DLLA 143 P 1532)	0 445 110 252	F00VC01342	Inyector Common Rail - Citroën C3 1.4HDI - Peugeot 206 1.4 HDI / 207 1.4 HDI.
0 433 171 945 (DLLA 138 P 1533)	0 445 110 248	F00VC01338	Inyector Common Rail - Fiat ducato motor JTD Iveco Daily 35/40/45/50cc
0 433 171 947 (DLLA 143 P 1536)	0 445 120 054	F00RJ01278	Inyector Common Rail - Iveco, Eurocargo, New Holland.
0 433 171 960 (DLLA 150 P 1557)	0 445 110 265	F00VC01353	Inyector Common Rail - Nueva Renault Master
0 433 171 961 (DLLA 149 P 1562)	0 445 120 063	F00RJ01533	Inyector Common Rail - Sisu 74 / 84.
0 433 171 962 (DLLA 152 P 1563)	0 445 120 062	F00RJ01522	Inyector Common Rail - Common Rail Sisu.
0 433 171 964 (DLLA 145 P 1068)	0 445 120 066	F00RJ01479	Inyector Common Rail - Volvo G900 con motor D7D Orig 04290986-5
0 433 171 965 (DLLA 156 P 1566)	0 445 120 074	F00RJ01451	Inyector Common Rail - Renault Midlum/Premium II Volvo.
0 433 171 966 (DLLA 137 P 1577)	0 445 120 075	F00RJ01278	Inyector Common Rail cosechadora Case 211 con motor 667.
0 433 171 974 (DLLA 142P 1595)	0 445 110 273	F00VC01338	Inyector Common Rail - Ducato 2.3 c/motor Fiat 4815
0 433 171 980 (DLLA 150P 1606)	0 445 110 269	F00VC01346	Inyector Common Rail - Chevrolet Captiva Cruze
0 433 171 982 (DLLA 153 P 1608)	0 445 110 274	F00VC01352	Inyector Common Rail - Kia Sorento 2.8 Common Rail.
0 433 171 988 (DLLA 143 P 1619)	0 445 120 089	F00RJ02067	Inyector Common Rail - VW Constellation 13.180 / 15.180 / 26.260 / 31.260 / Volvo 1265 VM210 / 1237 VM260 / 1236 VM310.
0 433 172 011 (DLLA 137 P 1648)	0 445 120 092	F00RJ01819	Inyector Common Rail - cosechadora New Holland CR9060.

N° Tobera	Código Inyector	3° Etapa	Aplicación
0 433 172 037 (DLLA 118 P 1691)	0 445 120 120	F00RJ01941	Inyector Common Rail - Ford Cargo C 2632 / 2932 / 4432 / E - VW 18.320 EOT / Constelación 19.320 Titan.
0 433 172 040 (DLLA 118 P 1697)	0 445 120 125	F00RJ01941	Inyector Common Rail - Ford Cargo 1832 - Renault.
0 433 172 051 (DLLA 145 P 1714)	0 445 120 133	F00RJ01941	Inyector Common Rail - Cummins.
0 433 172 083 (DLLA 126 P 1776)	0 445 120 140	F00RJ01941	Inyector Common Rail VW 18.320 EOT - Constellation 19.320 Titan / 25.320 / 31.320.
0 433 172 109 (DLLA 150 P 1817)	0 445 120 173	F00RJ01222	Inyector Common Rail - Volvo.
0 433 172 135 (DLLA 145 P 2135)	0 445 110 354	F00VC01379	Inyector Common Rail - Nueva Chevrolet S10.
0 433 172 147 (DLLA 150 P 2147)	0 445 110 375	F 00V C01 380	Inyector Common Rail - Renault Master 2.3 DCI
0 433 172 203 (DLLA 118 P 2203)	0 445 120 236	F00RJ01941	Inyector Common Rail - Ford Cargo 1832.
0 433 175 163 (DSL A 156 P 736)	0 445 110 024	F00VC01001	Inyector Common Rail - M. Benz Sprinter DCI 208 (OM611.987DeLA) / 211 (OM611.981DeLA) / 213 (OM611.981DeLA) / 216 (OM612.981DeLA) / 308 (OM611.987DeLA) / 311 / 313 / 316.
	0 445 110 011	F00VC01001	Inyector Common Rail - M. Benz 108 - 110 - 112 CDI vito.
	0 445 110 071	F00VC01001	Inyector Common Rail - M. Benz. C 200DCI / E200 DCI.
0 433 175 175 (DSL A 145 P 763)	0 445 110 002	F00VC01016	Inyector Common Rail - A. Romeo 156 / 145 / 146 1.9JTD - Fiat Bravo / Marea 1.9 JTD.
0 433 175 196 (DSL A 142 P 795)	0 445 110 044	F00VC01003	Inyector Common Rail - Citroën Berlingo Mot. M49 / Jumpi Mot. U64 / Xantia Mot. X2 2.0 HDI - Peugeot 206 2.0 HDI Mot. T1 - Expert 2.0 HDI Mot. U64 - Suzuki Grand Vitara 2.0 Tdi diesel turbo.
0 433 175 203 (DSL A 136 P 804)	0 445 120 002	F00RJ00005	Inyector Common Rail - Citroën Jumper 2.8 HDI - Fiat Ducato 10 / 11 / 14 / 15 / 18 2.8 JTD - Iveco Daily 29 L13 / 9 / Daily 35 C11 / 13 / 15 - Peugeot Boxer 2.8 HDI.
0 433 175 230 (DSL A 140 P 862)	0 445 110 146	F00VC01005	Inyector Common Rail - Laguna II 1.9 DCI - Master 1.9 DCI 80 - Scenic 1.9 DCI.
0 433 175 271 (DSL A 143 P 970)	0 445 120 007	F00RJ0339	Inyector Common Rail - Iveco 170 E25 (T) 240E25 (S) - Eurocargo 100 E17 / 18.

DESPIECE DE INYECTORES | TOBERAS

N° Tobera	Código Inyector	3° Etapa	Aplicación
0 433 175 272 (DSLA 144 P 971)	0 445 110 057	F00VC01013	Inyector Common Rail - Citroën C8 2.0 HDI / Jumpy 2.0 HDI - Peugeot 806 2.0 HDI / 807 2.0 HDI / Expert 2.0 HDI.
0 433 175 281 (DSLA 142 P 988)	0 445 110 062	F00VC01003	Inyector Common Rail - Citroën Berlingo 2.0HDI / C5 2.0HDI / Jumpy 2.0 HDI - Peugeot 307 2.0 HDI.
0 433 175 290 (DSLA 160 P 1016)	0 445 110 065	F00VC01017	Inyector Common Rail - Audi A8 3.3 TDI Q Reemplaza 0445110113.
0 433 175 298 (DSLA 154 P 1034)	0 445 110 069	F00VC01001	Inyector Common Rail - M. Benz 208 / 211 / 213 / 216 / 308 / 311 / 313 / 316 / 408 / 411 / 413 / DCI Sprinter.
0 433 175 308 (DSLA 146 P 1055)	0 445 110 135	F00VC01303	Inyector Common Rail - Citroën C3 1.4 HDI / Xsara 1.4 HDI - Peugeot 206 1.4 HDI / 16v / 307 1.4HDI.
0 433 175 310 (DSLA 140 P 1061)	0 445 110 078	F00VC01301	Inyector Common Rail - Volvo S60.2.4/S80/VT70II/XC70/XC90 .
0 433 175 314 (DSLA 156 P 1079)	0 445 110 054	F00VC01309	Inyector Common Rail - M. Benz E 200 / 220 / 270 DCI C / motor OM 646,951 / 961.
0 433 175 326 (DSLA 156 P 1113)	0 445 110 099	F00VC01045	Inyector Common Rail - M. Benz C 200 DCI T-Modell / 220 DCI / E 200 / 220 DCI.
0 433 175 337 (DSLA 140 P 1142)	0 445 110 110	F00VC01034	Inyector Common Rail - Nissan InterstarTurbo DCI80 - Renault Megane 1.9 DCI / Master 1.9 DCI80.
0 433 175 395 (DSLA 154 P 1320)	0 445 110 107	F00VC01045	Inyector Common Rail - M. Benz 208 / 211 / 213 / 216 / 308 / 311 / 313 / 316 / 408 / 411 / 416 DCI Sprinter.
	0 445 110 189	F00VC01051	Inyector Common Rail - Jeep Grand Cherokee 2.7 CRD - M .Benz 208 / 211 / 213 / 216 / 308 / 311 / 313 / 316 / 408 / 411 / 413 / 416 DCI Sprinter.
0 433 175 431 (DSLA 142 P 1474)	0 445 110 076	F00VC01053	Inyector Common Rail - Citroën C5 2.0HDI - Jumper 2.0 HDI - Fiat Ducato 11 2.0 JTD - Peugeot 206 / 307 / 406 / Boxer / Expert 2.0 HDI.
0 433 175 449 (DSLA 128P 1510)	0 445 120 059	F00RJ02130	Inyector Common Rail - Cummins
0 433 175 450 (DSLA 143 P 1523)	0 445 120 060	F00RJ02130	Inyector Common Rail - Komatsu PC220.
0 433 175 456 (DSLA 143 P 1535)	0 445 120 057	F00RJ01278	Inyector Common Rail - New Holland 93W - VW 1708 / 1908.
0 433 175 470 (DSLA 124P 1659)	0 445 120 032	F00RJ02339	Inyector Common Rail - Cummins

N° Tobera	Código Inyector	3° Etapa	Aplicación
0 433 175 499 (DSLA 143 P 5499)	0 445 120 210	F00RJ02130	Inyector Common Rail - Cummins.
0 433 175 500 (DSLA 124 P 5500)	0 445 120 208	F00RJ02130	Inyector Common Rail - VW Omnibus 18320 / 19320.
0 433 175 501 (DSLA 143 P 5501)	0 445 120 212	F00RJ02130	Inyector Common Rail - Ford Cargo C1317-15-17-1717-1712-2422-VW8150
0 433 175 510 (DSLA 128 P 5510)	0 445 120 231	F00RJ02130	Inyector Common Rail - Cummins - Reemplaza 0445120059.
0 433 175 516 (DSLA 124 P 5516)	0 445 120 238	F00RJ02130	Inyector Common Rail - Motor Cummins.
0 433 175 517 (DSLA 143 P 5517)	0 445 120 250	F00RJ02130	Inyector Common Rail - Komatsu PC220-8 - 503.Ree a 0445120060
0 433 175 540 (DSLA 143P5540)	0 445 120 273	F00RJ02130	Inyector Common Rail - Motor Cummins.

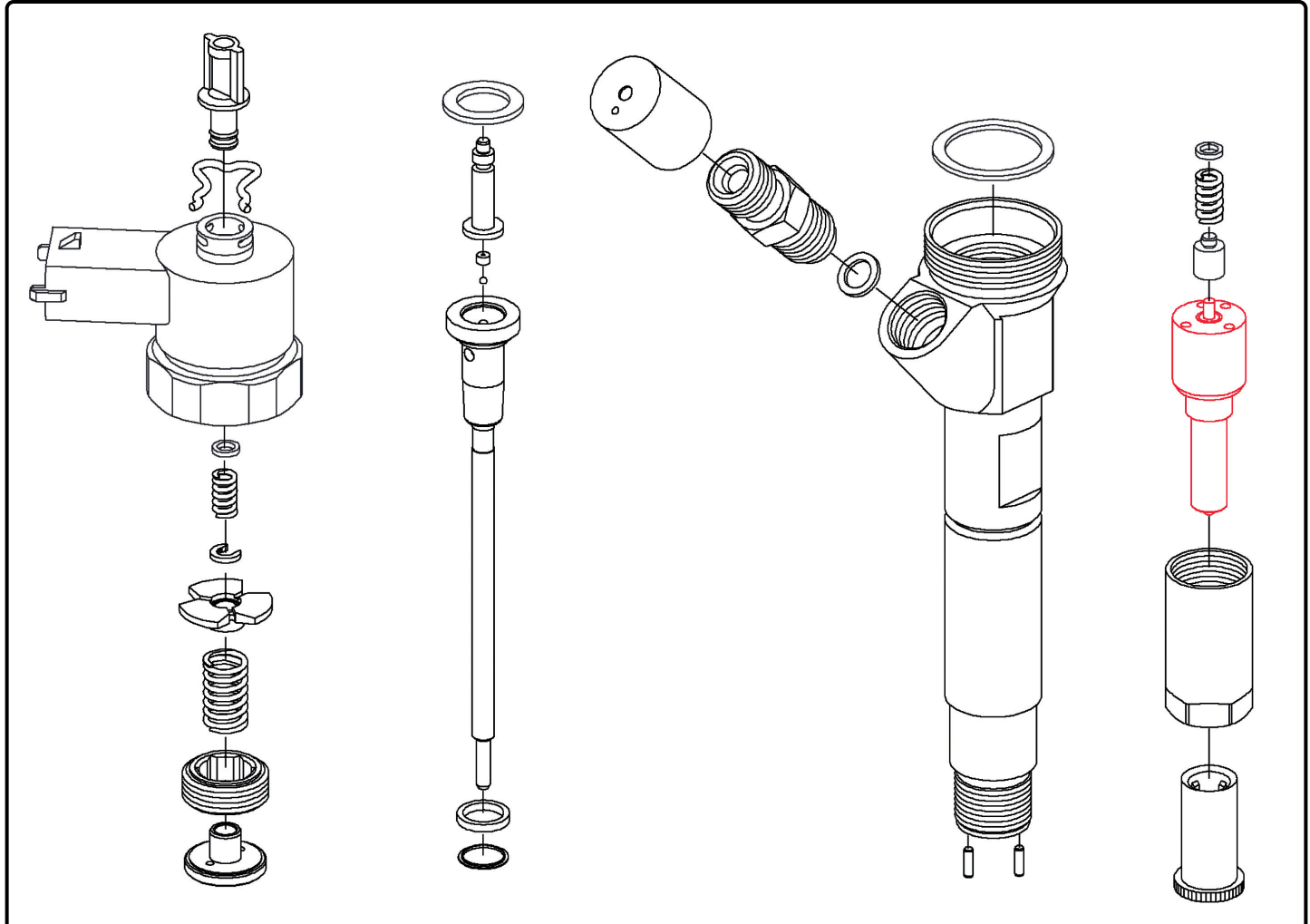

JUEGO DE VÁLVULAS 3° ETAPA

Código	Nº de Pieza	Codigo Inyector	Aplicación	
F 00R J00 005	4	0 445 120 002	Juego de válvulas de 3° etapa - Peugeot Boxer 2,8hdi / Citroën Jumper 2,8hdi / Iveco Daily.	
F 00R J00 339	4	0 445 120 007 0 445 120 018 0 445 120 032 0 445 120 079 0 445 120 103	Juego de válvulas de 3° etapa - Ford Cargo 1317 E / 1722 E - EuroCargo 170E 25 / 240 E25 / 100E17 / 120 E18.	 Imagen Ilustrativa
F 00R J00 399	4	0 445 120 009 0 445 120 010 0 445 120 014 0 445 120 015 0 445 120 019 0 445 120 020 0 445 120 084 0 445 120 085	Juego de válvulas de 3° etapa - Renault 420-370 Premium L.	
F 00R J01 052	4	0 445 120 028 0 445 120 069	Juego de válvulas de 3° etapa - Iveco / Cummins	
F 00R J01 222	4	0 445 120 033 0 445 120 034 0 445 120 051 0 445 120 052 0 445 120 096 0 445 120 108 0 445 120 173 0 445 120 174 0 445 120 175 0 445 120 176	Juego de válvulas de 3° etapa - IPL - Volvo Penta.	
F 00R J01 278	4	0 445 120 054 0 445 120 057 0 445 120 075	Juego de válvulas de 3° etapa - IFL - EuroCargo 100 E18 / 100 E18 / N . Holland 93 W1708 / 1908.	
F 00R J01 451	4	0 445 120 064 0 445 120 074	Juego de válvulas de 3° etapa - Renault, Camiones Premium / Midlum / Volvo fe / fl.	

Código	Nº de Pieza	Codigo Inyector	Aplicación	
F 00R J01 479	4	0 445 120 066 0 445 120 067	Juego de válvulas de 3º etapa - IPL - Volvo 6900 Motor D 7D.	
F 00R J01 522	4	0 445 120 062	Juego de válvulas de 3º etapa - Sisu	
F 00R J01 533	4	0 445 120 063	Juego de válvulas de 3º etapa - IPL - Isuzu.	
F 00R J01 819	4	0 445 120 092 0 445 120 157 0 445 120 279 0 445 120 282	Juego de válvulas de 3º etapa - IPL - Case New Holland CR 9060.	
F 00R J01 941	4	0 445 120 029-037- 070-097-112-115- 120-121-122-125- 133-140-144-159- 236-237-240-241- 253-272-273	Juego de válvulas de 3º etapa - IFL - Ford Cargo C2632E / C2932 E / VW 18.320 EOT.	
F 00R J01 945	4	0 445 120 010 0 445 120 113	Juego de válvulas de 3º etapa - Dodge Ram 2500/3500	
F 00R J02 067	4	0 445 120 043 0 445 120 077 0 445 120 089	Juego de válvulas de 3º etapa - IPL - VW 15.180 - 15.190 - 17.210 - 17.230 - 17.260 EOD Electronic - 8.150 - 9.150 EOD Electronic.	
F 00R J02 130	4	0 445 120 059-060- 123-132-151-152- 208-209-210-211- 212-231-238-239- 250-251-252-254- 255-256	Juego de válvulas de 3º etapa - IF - Ford Cargo C1317E / 1517E / 1717E / 1722E / F250 4BTAA.	

JUEGO DE VÁLVULAS 3° ETAPA

Código	Nº de Pieza	Codigo Inyector	Aplicación	
F 00V C01 001	4	0 445 110 003-004-005-006-009-010-011-012-014-015-024-035-045-046-069-070-071-072-073-074-093-094	Juego de válvulas de 3° etapa - IPS - M. Benz C 200 DCI / C 220 DCI / E 200 DCI / A 160 / 170 DCI.	
F 00V C01 003	4	0 445 110 008 0 445 110 020 0 445 110 044 0 445 110 062	Juego de válvulas de 3° etapa - IPS - Peugeot 306 / 408 / 206 HDI - Expert - Partner 2.0 HDI / C.Berlingo / Jumpy / Xantia 2.0HDI - Suzuki G. Vitara 2.0 Tdi D. Turbo.	 Imagen Ilustrativa
F 00V C01 013	4	0 445 110 057	Juego de válvulas de 3° etapa - IPS - Peugeot Expert / 807 / 806 2.0 HDI / Citroën Jumpy 2.0 HDI.	
F 00V C01 015	4	0 445 110 059	Juego de válvulas de 3° etapa - IPL - Voyager 2.5-2.8.	
F 00V C01 016	4	0 445 110 001 0 445 110 002	Juego de válvulas de 3° etapa - IPS - A. Romeo 145 / 146 / 156 1.9 JTD - Fiat Brava 1.9 JTD - Marea 1.9 JTD.	
F 00V C01 022	4	0 445 110 084 0 445 110 087 0 445 110 102 0 445 110 184	Juego de válvulas de 3° etapa - IFS - Renault Master 2.5 DCI 120 - Laguna II 2.2 DCI - Nissan Interstar 2.5 D.Turbo DCI 120.	 Imagen Ilustrativa
F 00V C01 023	4	0 445 110 081 0 445 110 125 0 445 110 231 0 445 110 336 0 445 110 337	Juego de válvulas de 3° etapa - IPL - Chevrolet 2.8 D.Electronic - S10 2.8 D.E. / Nissan Frontier 2.8 D. Electronic - X Terra 2.8.	 Imagen Ilustrativa
F 00V C01 024	4	0 445 110 089 0 445 110 090 0 445 110 097 0 445 110 098 0 445 110 115 0 445 110 116	Juego de válvulas de 3° etapa - IPL - M. Benz A 160 / 170 DCI - M. Benz Vaneo DCI 1.7.	

Código	Nº de Pieza	Codigo Inyector	Aplicación	
F 00V C01 033	4	0 445 110 091 0 445 110 092 0 445 110 185 0 445 110 186 0 445 110 279 0 445 110 283 0 445 110 306	Juego de válvulas de 3º etapa - IPL - Kia Sorento 2.5 CRDI - Hyundai H1 2.5CRDI - Hyundai H-1 2.5 CRDI.	
F 00V C01 034	4	0 445 110 109 0 445 110 110 0 445 110 127 0 445 110 144 0 445 110 145 0 445 110 160 0 445 110 178	Juego de válvulas de 3º etapa - IFS - Renault Kangoo I 1.9 DCI - Laguna II 1.9 DCI - Megane Classic 1.9 DCI - Scenic 1.9 DCI - Nissan Interstar D.T. DCI 80.	
F 00V C01 038	4	0 445 110 083	Juego de válvulas de 3º etapa - IPL - Fiat Idea 1.3 JTD 16V - Punto 1.3 MJTD 16V - Opel Corsa 1.3 CDTI - Meriva 1.3 CDTI.	
F 00V C01 043	4	0 445 110 047 0 445 110 048 0 445 110 049 0 445 110 130 0 445 110 266	Juego de válvulas de 3º etapa - IFS - Range Rover III 3.0 Td6 - BMW 330d / 330d Touring / 530d / 525 d / L.R. Freelander I 2.0 Td4.	
F 00V C01 044	4	0 445 110 064 0 445 110 101 0 445 110 126 0 445 110 290	Juego de válvulas de 3º etapa - IPL - Hyundai Santa Fe 2.0 CRDI / Kia Sportage New 2.0 CRDI.	
F 00V C01 045	4	0 445 110 095-096-099-100-103-104-105-106-107-108-120-121-151-152-170-171	Juego de válvulas de 3º etapa - IPS - M. Benz 211 / 213 / 216 / 311 / 313 / 316 DCI Sprinter / C200 / 220 / E200 / 220 / 270 DCI.	
F 00V C01 046	4	0 445 110 119	Juego de válvulas de 3º etapa - IPS - A. Romeo 147 / 156 1.9JTD - Fiat Stilo - Marea 1.9 JTD.	
F 00V C01 051	4	0 445 110 181-182-189-190-199-200-201-202-205-206-207-208-224-225	Juego de válvulas de 3º etapa - IPS - M. Benz 108 / 110 / 112 DCI Vito / 311 / 313 / 413 DCI Sprinter / C200 / 220 / 270 DCI - Jeep G. Cherokee 2.7 CRD.	

Imagen Ilustrativa

JUEGO DE VÁLVULAS 3° ETAPA

Código	Nº de Pieza	Codigo Inyector	Aplicación	
F 00V C01 053	4	0 445 110 076 0 445 110 240	Juego de válvulas de 3° etapa - IPS - Citroën Xsara - C5 - Jumper 2.0 HDI - Peugeot 307 HD - Fiat Ducato 11 2.0 JTD.	
F 00V C01 054	4	0 445 110 195 0 445 110 203	Juego de válvulas de 3° etapa - Cherokee (5Cil) / M. Benz Sprinter.	
F 00V C01 303	4	0 445 110 075 0 445 110 135	Juego de válvulas de 3° etapa - IPL - Peugeot 206 / 307 1.4 HDI - Citroën C3 1.4 HDI - Xsara 1.4 HDI.	
F 00V C01 310	4	0 445 110 122 0 445 110 131	Juego de válvulas de 3° etapa - IFL - BMW 740D / 330D / 530D / X5 3.0 D.	
F 00V C01 315	4	0 445 110 136-188- 200-239-259-271- 282-285	Juego de válvulas de 3° etapa - IFL - Peugeot 206 1.6 / 307 HDI - Partner 1.6 HDI / Ford Focus C-Max 1.6TDCI - Citroën C4 / C5 / Xsara Picasso 1.6 HDI / Volvo C30 1.6 D Drive.	 Imagen Ilustrativa
F 00V C01 331	4	0 445 110 209 0 445 110 212 0 445 110 216 0 445 110 219 0 445 110 301 0 445 110 400	Juego de válvulas de 3° etapa - IFL - BMW 118D / 318D / 325D / 525D / 330D / X3 2.0 / 3.0 D / X5 3.0 / 120D 2.0 / 535D.	
F 00V C01 334	4	0 445 110 183- 260-309-310-316- 322-331	Juego de válvulas de 3° etapa - IPL - A. Romeo MITO1.3JTD - Fiat Línea 1.3JTD - Punto Evo 1.3 JTD.	 Imagen Ilustrativa
F 00V C01 338	4	0 445 110 247 0 445 110 248 0 445 110 273	Juego de válvulas de 3° etapa - IPL - Iveco Daily 1766 35 S14 / 1768 55 C 16 / 1732 55 S 18 - Fiat Ducato 11 3.0 JTD.	

Código	Nº de Pieza	Codigo Inyector	Aplicación	
F 00V C01 342	4	0 445 110 252	Juego de válvulas de 3° etapa - IPL - Peugeot 207 1.4 HDI / 206 1.4 HDI - Citroën C3 1.4HDI.	 Imagen Ilustrativa
F 00V C01 345	4	0 445 110 251	Juego de válvulas de 3° etapa - IPL - Volvo C30 D5 / S540 II D5.	 Imagen Ilustrativa
F 00V C01 346	4	0 445 110 269	Juego de válvulas de 3° etapa - Hyundai Santa Fe 2,2 CRDI, Kia Sportage 2,0CRDI, Chevrolet Captiva, Inyectores Varios.	
F 00V C01 352	4	0 445 110 274 0 445 110 275 0 445 110 277 0 445 110 278	Juego de válvulas de 3° etapa - Kia Sorento 2.8 Ckdi - Hyundai H1 2.5 CRDI Cargo.	
F 00V C01 353	4	0 445 110 265	Juego de válvulas de 3° etapa - Renault Master 2,5 DCI.	
F 00V C01 379	4	0 445 110 354 0 445 110 424	Juego de válvulas de 3° etapa - Chevrolet S10 modelo nueva 2,8 CDTI.	 Imagen Ilustrativa
F 00V C01 380	4	0 445 110 375	Juego de válvulas de 3° etapa - Renault Master 2.3 DCI	 Imagen Ilustrativa

JUEGO DE VÁLVULAS 3° ETAPA

Código	Inyector	Aplicación
F 00R J04 566	0 445 120 002	CITROËN Jumper 2.8 HDI /
F 00R J04 568	0 445 120 043	
F 00R J04 597	0 445 120 089	
F 00R J04 569	0 445 120 120	
F 00R J04 598	0 445 120 140	
F 00R J04 567	0 445 120 007	
F 00R J04 570	0 445 120 212	
F 00R J04 599	0 445 120 273	

ESFERAS / GUIAS

Código	Nº de Pieza	Inyector	Aplicación
F 00V C05 001	6	0 445 110 001	Esfera de válvula Inyector Common Rail - A. Romeo 145 / 146 1.9 JTD / 156 1.9 JTD - Fiat Marea 1.9 JTD - Citroën Berlingo 2.0 HDI. Cummins. Sprinter. Acero 1,34 mm con guía F 00V C21 001
F 00V C05 006	6	0 445 110 183 0 445 110 319	Esfera de válvula de tercer etapa reemplazable por la F 00V C05 009. A. Romeo, Fiat, Ford, Kia. De cerámica 1,50 mm con guía F 00V C21 002
F 00V C05 008	6	0 445 110 054	Esfera de válvula Inyector Common Rail - BMW - Volvo. M. Benz, Audi, Cherokee, Citroën, Fiat, Ford. De cerámica 1,34 mm con guía F 00V 021 001
F 00V C05 009	6	0 445 110 183 0 445 110 319	Esfera de válvula de tercer etapa reemplazable por la F 00V C05 006. Con guía F 00V C21 002
F 00V C21 001	7	0 445 110 001	Guía de esfera Inyector Common Rail - Citroën Berlingo 2.0 HDI - Xantia 2.0 HDI - M. Benz. 208 / 211 / 213 / 308 / DCI Sprinter. Para bolilla 5 001 y 5 008
F 00V C21 002	7	0 445 110 183 0 445 110 319	Guía de esfera de válvula de tercer etapa para Inyector para bolilla 5 006 y 5 009.

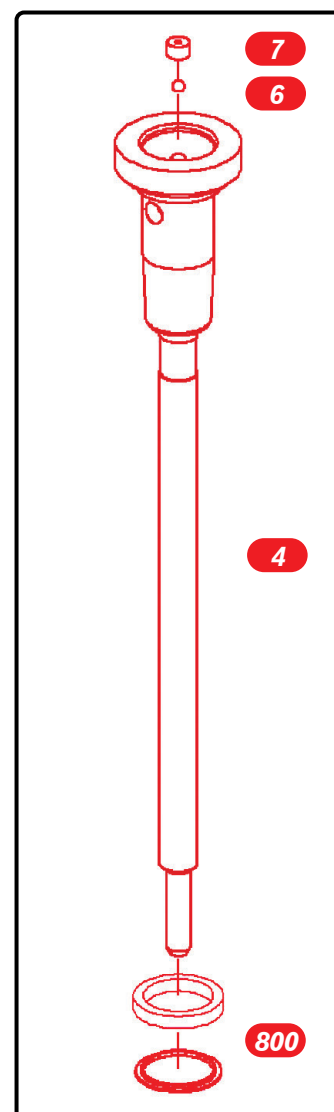

SELLOS / EMPAQUETADURAS

Código	Nº de Pieza	Inyector	Aplicación
F 00R J02 177	800	0 445 120 050 0 445 120 186 0 445 120 327	Sellos / Empaquetadura. Juego de anillos de válvula para Inyector Common Rail New Holland, Dodge Ram, Iveco. VW Constellation. Agrale Deutz.
F 00V C99 002	800	0 445 110 075 0 445 110 189 0 445 110 076	Sellos / Empaquetadura. Juego de anillos de válvula Inyector Common Rail - A. Romeo 145 1.9 JTD - Citroën Berlingo / Jumpy / Xantia / Picasso 2.0 HdI - Peugeot 206 / 406 / Expert 2.0 HDI.



INDUCIDOS / ELECTROIMANES

Código	Nº de Pieza	Inyector	Aplicación	
F 00R J00 395	2	0 445 120 002	Grupo magnético (Inducido) Inyector Common Rail - Iveco Daily - Citroën Jumper - Fiat Ducato - Peugeot Boxer.	
F 00R J01 638	802	0 445 120 074	Grupo magnético (Inducido) Inyector Common Rail - Sisu 74/84 CTA. Renault Midlum, Ford, Volkswagen c/ Cummins.	
F 00R J02 697	802	0 445 120 007	Grupo magnético (Inducido) Inyector Common Rail - Rail Iveco. Cummins, Ford Cargo, VW.	
F 00R J02 703	802	0 445 120 066	Grupo magnético (Inducido) Inyector Common Rail - Deutz, Volvo, VW. Reemplaza a F 00R J02 706	
F 00R J02 706	802	Ree. x F 00R J02 703	Grupo magnético (Inducido) Inyector Common Rail - Cosechadora New Holland CR 9060. Dodge Ram - Iveco - Eurocargo.	 Imagen Ilustrativa
F 00V C30 054	2	0 445 110 003-004-009-010-011-012-024-025-034-035-045	Grupo magnético Inyector Common Rail - M. Benz. C200 Sprinter - C200 / E200 / E220 DCI / 208 / 211 / 213 / 216 / 308 / 311 / 316 DCI Sprinter.	
F 00V C30 057	2	0 445 110 076	Grupo magnético (Inducido) Inyector Common Rail Varios - Citroën C4, Jumper, Xsara, Peugeot 206, Land Rover, Hyundai.	

INDUCIDOS / ELECTROIMANES

Código	Nº de Pieza	Inyector	Aplicación	
F 00V C30 058	2	0 445 110 038	Grupo magnético (Inducido) Inyector Common Rail - Renault Master, Chrysler, Nissan Frontier.	
F 00V C30 308	2	0 445 110 075-135- 0 445 110 249-250	Grupo magnético (Inducido) Inyector Common Rail - Peugeot 206 / 307 1.4 HDI - Citroën C3 / Xsara 1.4 HDI.	
F 00V C30 316	2	0 445 110 083-111	Grupo magnético (Inducido) Inyector Common Rail - Fiat Idea 1.3 JTD 16V / Stilo / Punto MJTD 16V - A. Romeo 147 / 156 / 1.9 JTDM 16v / 166 2.4 JTD.	 Imagen ilustrativa
F 00V C30 318	2	0 445 110 159-83- 213-43-55-56-61- 65-74-75-77	Grupo magnético (Inducido) Inyector Common Rail - Renault Master 2.5 DCI 100 - Hyundai H1 2.5 CRDI Cargo - Fiat Stilo 1.9 JTD 16v - A. Romeo 159 2.4 JTDM.	 Imagen ilustrativa
F 00V C30 319	2	0 445 110 165-244- 8-53-4-7-8-260-9- 70-3-6-80	Grupo magnético (Inducido) Inyector Common Rail - Fiat Ducato 3.0 JTD - Iveco Daily 35 C15 / C18 / S14 / S15 / S18 / 40 / C15 / C18 - Hyundai Santa Fe 2.2 CRDI.	
F 00V C30 321	2	0 445 110 252	Grupo magnético (Inducido) Inyector Common Rail - Citroën C3 1.4 HDI - Peugeot 206 / 207 / 1.4 HDI.	 Imagen ilustrativa
F 00V C30 322	2	0 445 110 297 0 445 110 311	Grupo magnético (Inducido) Inyector Common Rail - Citroën Berlingo C2 / C3 / C4 / C5. Peugeot 206 / 207 / 3008 / 307 / 308 / 407 / 5008 / Partner.	

O'RINGS





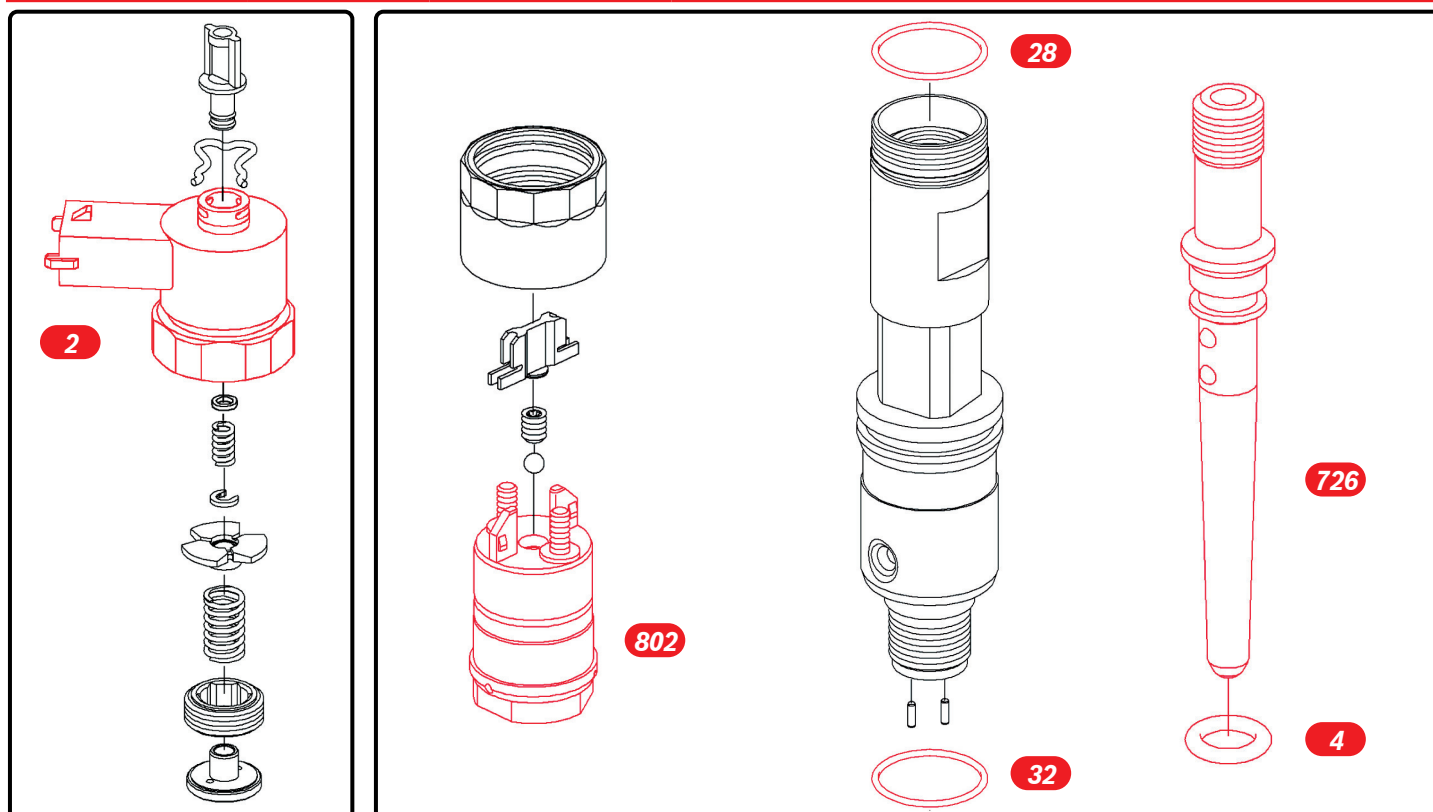

Código	Nº Figura	Inyector	Aplicación
2 430 210 081	32	0 445 120 007	O´ring de sellado Cummins.
2 430 210 082	4	0 445 120 007	O´ring de cánula Cummins.
F 00R J00 220	28	0 445 120 007 0 445 120 212	O´ring de inducido para Inyector Common Rail IPL EuroCargo 100E17 / VW 15.180 / 15.90 / 17.210 EOD Electronic. Cummins.
F 00R J00 222	28	0 445 120 064	O´ring de inducido para Inyector Common Rail. IPL Renault Midlum – New Holland - VW Delibery.
F 00R J00 529	4	0 445 120 025	O´ring de cánula de Inyector IPL - Ford Cargo - 1830 - 2524.
F 00R J01 452	32	0 445 120 064	O´ring de cuerpo de Inyectores Common Rail varios / Camiones Renault.
F 00R J01 605	32	0 445 120 134	O´ring de cuerpo de Inyector VW - Cummins.
F 00R J01 878	32	0 445 120 005 - 010 - 014 - 019	O´ring de cuerpo de Inyector - Renault Premium.

:: CÁNULAS

Código	Nº Figura	Inyector	Aplicación
F 00R J01 280	726	0 445 120 054	Racord - Tubo de presión (cánula) para Inyectores Common Rail - Iveco, Eurocargo, New Holland.
F 00R J01 224	726	0 445 120 113	Racord - Tubo de presión (cánula) para Cummins Dodge Ram - Reemplaza a F00RJ01572.
F 00R J00 414	726	0 445 120 007 0 445 120 212	Racord - Tubo de presión (cánula) para Inyectores Common Rail - IF Iveco Eurocargo 170E25 / 240E - Ford Cargo C1317E / 1517E / 1717 E / F250. Cummins - Ford - Volkswagen.
F 00R J01 535	726	0 445 120 063 0 445 120 340	Racord - Tubo de presión (cánula) Sisu 74/84 cta.



JUEGOS DE REPARACIÓN

Código	Inyector	Aplicación	
F 00R J02 760	Varios	Kits de arandelas de Inyector Common Rail. Línea pesado, incluye arandelas redondas y hexagonales.	
F 00V C99 004	0 445 110 273 / 401	Juego de reparación plato de inducido Inyector Common Rail. Fiat Ducato, Mini Cooper.	
F 00Z C99 007	0 445 110 189	Juego de reparación plato de inducido M. Benz Sprinter.	
F 00Z C99 008	0 445 110 076	Juego de reparación plato de inducido Citroën C4 / Xsara - Peugeot 206 / 307 / Boxer / Expert / Partner.	
F 00Z C99 009	Varios	Kit de arandelas de calibración para Inyectores Common Rail varios.	
F 00R J02 517	0 445 120 007	Juego de reparación plato de inducido Ford, Iveco, Cummins.	

TUERCAS

Código	N° Figura	Inyector	Aplicación
F 00R J00 337	20	0 445 120 012 0 445 120 016	Tuerca porta tobera Common Rail Renault Midlum 270. Premium. Reemplazado por F 00R J02 168
F 00R J00 840	11	0 445 120 007	Tuerca tensora de inducido para Inyectores Common Rail varios. Cummins, Ford, Volkswagen.
F 00R J00 841	20	0 445 120 007	Tuerca portatobera Common Rail IF - Iveco EuroCargo - Dodge Ram 2500 6.7 Pickup.
F 00R J00 845	43	0 445 120 025	Tuerca fijación grupo magnético Common Rail IPL - Volvo VM 260 / 310 MWM 6.12 TCE.
F 00R J01 005	11	0 445 120 074	Tuerca tensora de inducido Inyector Renault Midlum, Ford, Volkswagen c/ Cummins.
F 00R J02 219	20	0 445 120 074	Tuerca portatobera common Rail. Reemplaza a F00RJ00713. Renault Midlum, Ford, Volkswagen c/ Cummins.
F 00V C13 002	11	0 445 110 231	Tuerca tensora de inducido para Inyectores Common Rail varios. Chevrolet S10 Blazer.
F 00V C13 007	11	0 445 110 189	Tuerca tensora de inducido para Inyectores Common Rail varios. M. Benz Sprinter.
F 00V C13 300	11	0 445 120 122	Tuerca tensora de inducido para Inyectores Common Rail varios. BMW, Isuzu, Mitsubishi.
F 00V C14 010	20	0 445 110 008	Tuerca portatobera Common Rail - Cherokee 2.5 TD - Peugeot 307 2.0HDI.
F 00V C14 012	20	0 445 110 189 0 445 110 231	Tuerca porta tobera Common Rail - A. Romeo 145 1,9 JTD, 146 1,9 JTD, 156 1,9 JTD. Fiat Brava 1,9 JTD, Bravo 1,9 JTD, Marea 1,9 JTD, Palio Weekend 1,9 JTD, Punto 1,9 JTD, Idea 1,9 JTD 8V, Punto 1,9 JTD, Stilo 1,9 JTD, Doblo 1,9 JTD. M. Benz 108 CDI Vito, 110 CDI Vito, 112 CDI Vito, C200 CDI, E200 CDI, A160 Vito, A 170 Vito, 208 CDI Sprinter, 211 CDI Sprinter, 213211 CDI Sprinter, 216211 CDI Sprinter, 308211 CDI Sprinter.

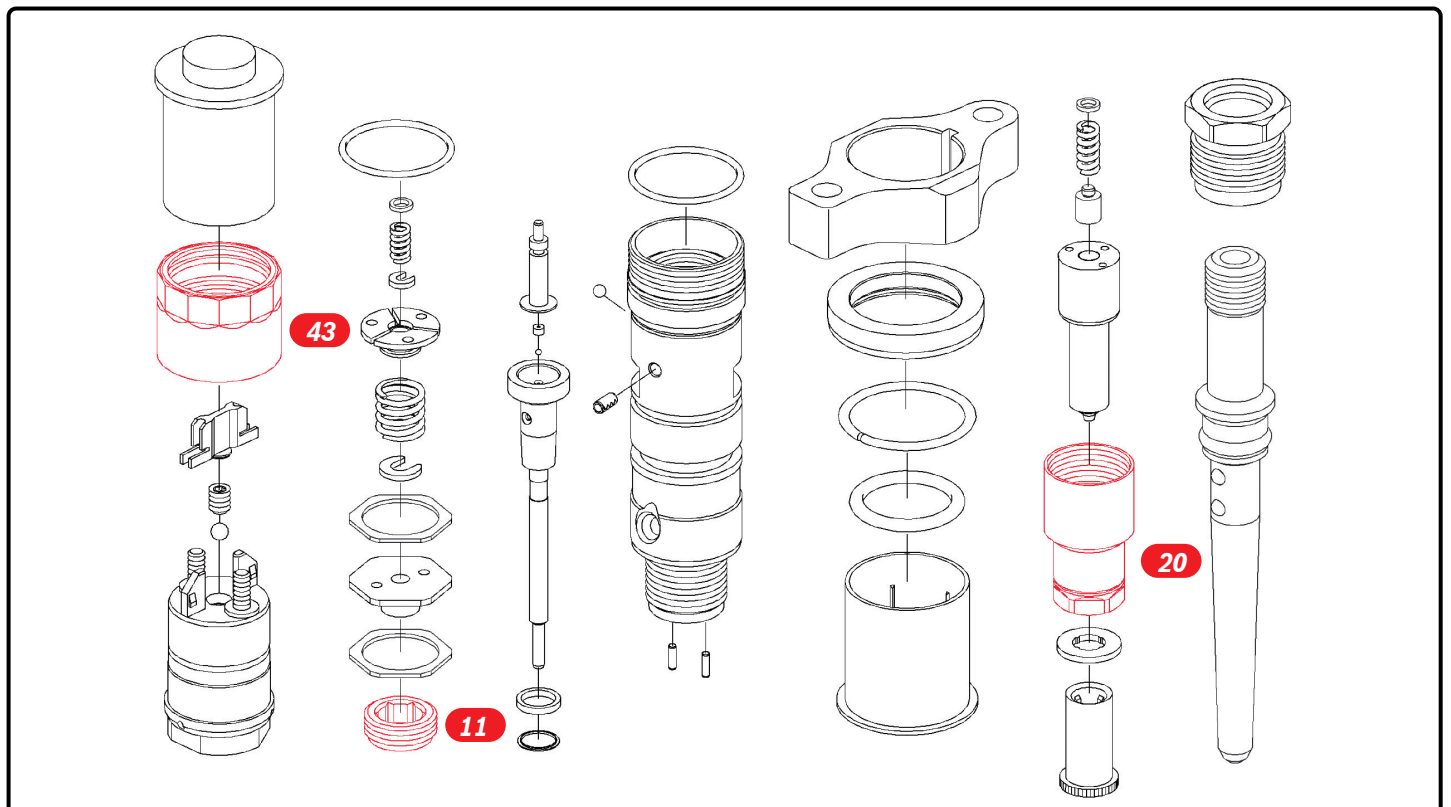

ARANDELAS DE CALIBRACIÓN AH (HEXAGONALES)

Código	N° Figura	Reemplaza a:	Espesor
Arandela de calibración inferior para platillo de inducido - Citroën Jumper 2.8HDI - Peugeot Boxer 2.8 HDI - Iveco Daily motor 8140 - Renault camión - Volkswagen camión con motor Cummins - Ford Cargo con motor Cummins - Inyectores 0445120002 / 003 / 007 / 012 / 014 / 019 / 028 / 043 / 059 / 060 / 089 / 114 / 120 / 125 / 151.			
F 00R J00 024	8		0,950 mm
F 00R J04 093	8	F 00R J00 026	0,954 mm
F 00R J00 028	8		0,958 mm
F 00R J00 030	8		0,962 mm
F 00R J00 032	8		0,966 mm
F 00R J00 034	8		0,970 mm
F 00R J00 036	8		0,974 mm
F 00R J00 038	8		0,978 mm
F 00R J00 040	8		0,982 mm
F 00R J00 042	8		0,986 mm
F 00R J00 044	8		0,990 mm
F 00R J00 046	8		0,994 mm
F 00R J00 048	8		0,998 mm
F 00R J00 050	8		1,002 mm
F 00R J00 052	8		1,006 mm
F 00R J00 054	8		1,010 mm
F 00R J00 056	8		1,014 mm
F 00R J00 058	8		1,018 mm
F 00R J00 060	8		1,022 mm
F 00R J00 062	8		1,026 mm
F 00R J00 064	8		1,030 mm
F 00R J00 066	8		1,034 mm
F 00R J00 068	8		1,038 mm
F 00R J00 070	8		1,042 mm
F 00R J00 072	8		1,046 mm
F 00R J00 074	8		1,050 mm
F 00R J00 076	8		1,054 mm
F 00R J04 239	8		1.125 mm

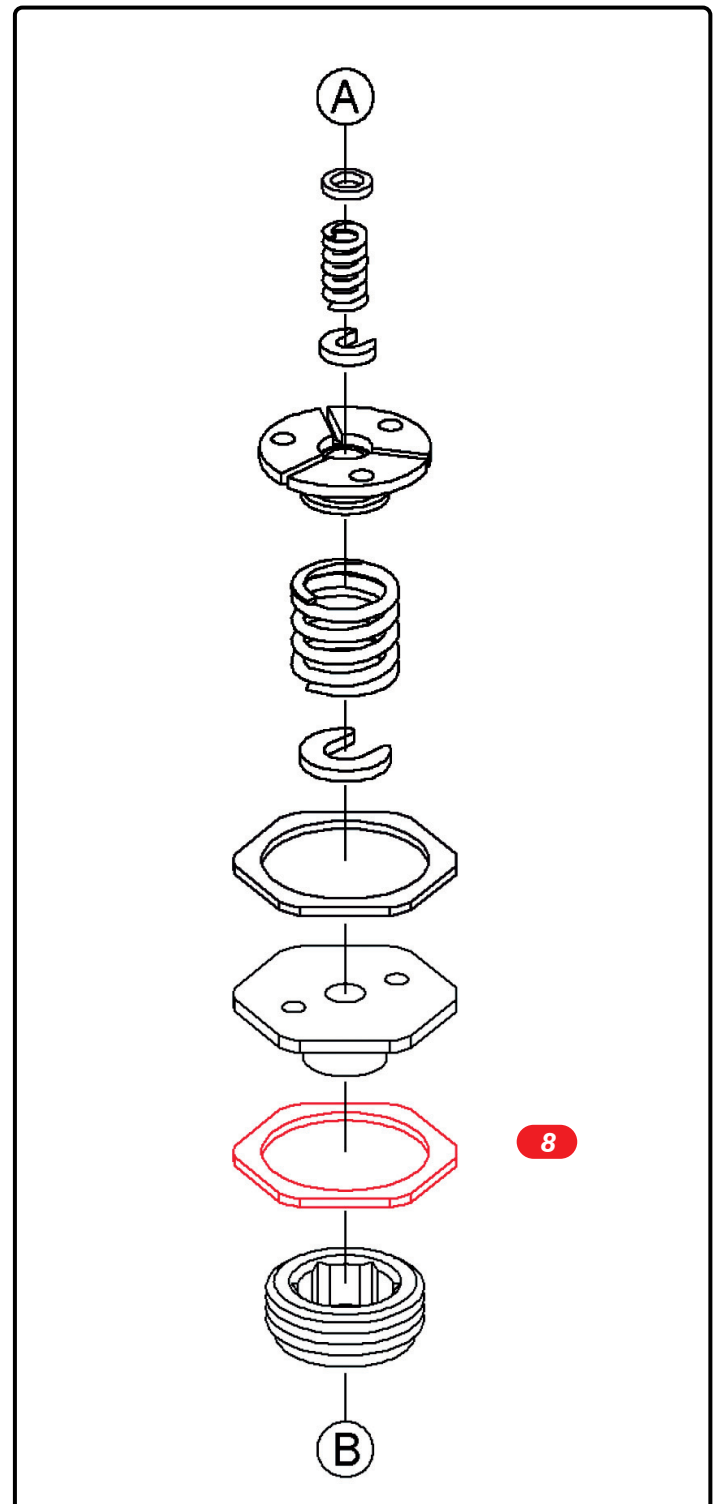
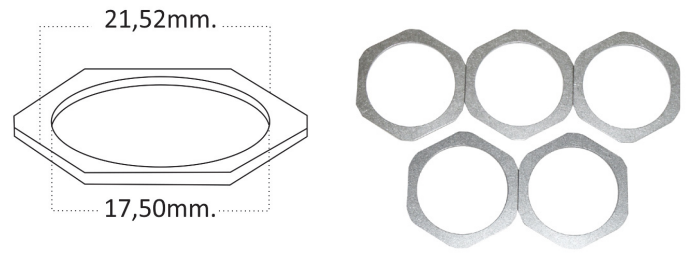

ARANDELAS DE CALIBRACIÓN AG (HEXAGONALES)

Código	Nº Figura	Espesor
Arandela de calibración superior para plato de Inducido, Inyector Common Rail - A. Romeo 145 1.9 JTD - Fiat Brava 1.9 JTD - Citroën Berlingo 2.0 HDI - Inyectores CRI 0 445 120 002 -003 -004 -005 -006 -007-008 -009 -010 -011-012 -013 - 014 -015 -016 -017 -018 -019 -020		
F 00R J00 120	23	1,21 mm
F 00R J00 122	23	1,22 mm
F 00R J00 124	23	1,23 mm
F 00R J00 126	23	1,24 mm
F 00R J00 128	23	1,25 mm
F 00R J00 130	23	1,26 mm
F 00R J00 132	23	1,27 mm
F 00R J00 134	23	1,28 mm
F 00R J00 136	23	1,29 mm
F 00R J00 138	23	1,30 mm
F 00R J00 140	23	1,31 mm
F 00R J00 142	23	1,32 mm
F 00R J00 144	23	1,33 mm
F 00R J00 146	23	1,34 mm
F 00R J00 148	23	1,35 mm
F 00R J00 150	23	1,36 mm
F 00R J00 152	23	1,37 mm
F 00R J00 154	23	1,38 mm

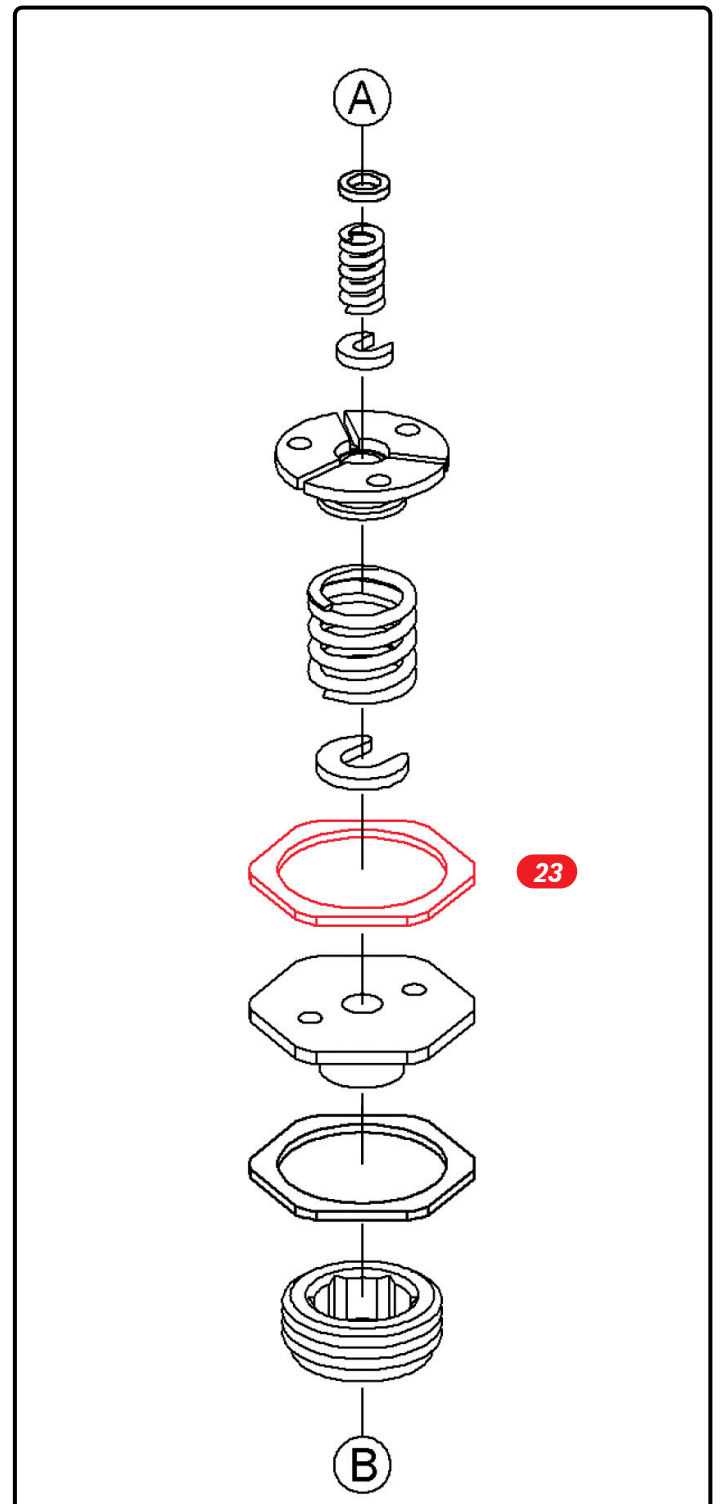
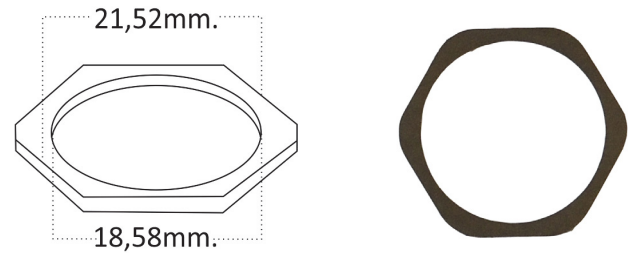

ARANDELAS DE CALIBRACIÓN AH (REDONDAS)

Código	N° Figura	Espesor
--------	-----------	---------

Arandela de calibración del cuerpo de Inyector Common Rail - New Holland cosechadora motor Iveco - Cosechadora Case Serie 800 - Camión Volkswagen Contellation con motor MWM - Volvo 210 con motor MWM - Inyectores 0445120053 / 063 / 066 / 067 / 075 / 089 / 092.

F 00R J00 869	8	1,512 mm
F 00R J00 871	8	1,516 mm
F 00R J00 873	8	1,520 mm
F 00R J00 875	8	1,524 mm
F 00R J00 877	8	1,528 mm
F 00R J00 879	8	1,532 mm
F 00R J00 881	8	1,536 mm
F 00R J00 883	8	1,540 mm
F 00R J00 885	8	1,544 mm
F 00R J00 887	8	1,548 mm
F 00R J00 889	8	1,552 mm
F 00R J00 891	8	1,556 mm
F 00R J00 893	8	1,560 mm
F 00R J00 895	8	1,564 mm
F 00R J00 897	8	1,568 mm
F 00R J00 899	8	1,572 mm
F 00R J00 901	8	1,576 mm
F 00R J00 903	8	1,580 mm
F 00R J00 905	8	1,584 mm
F 00R J00 907	8	1,588 mm
F 00R J00 909	8	1,592 mm
F 00R J00 911	8	1,596 mm
F 00R J00 913	8	1,600 mm
F 00R J00 915	8	1,604 mm
F 00R J00 917	8	1,608 mm
F 00R J00 919	8	1,612mm
F 00R J00 921	8	1,616 mm
F 00R J00 923	8	1,620 mm
F 00R J00 925	8	1,624 mm
F 00R J00 927	8	1,628 mm
F 00R J00 929	8	1,632 mm
F 00R J00 931	8	1,636 mm
F 00R J00 933	8	1,640 mm

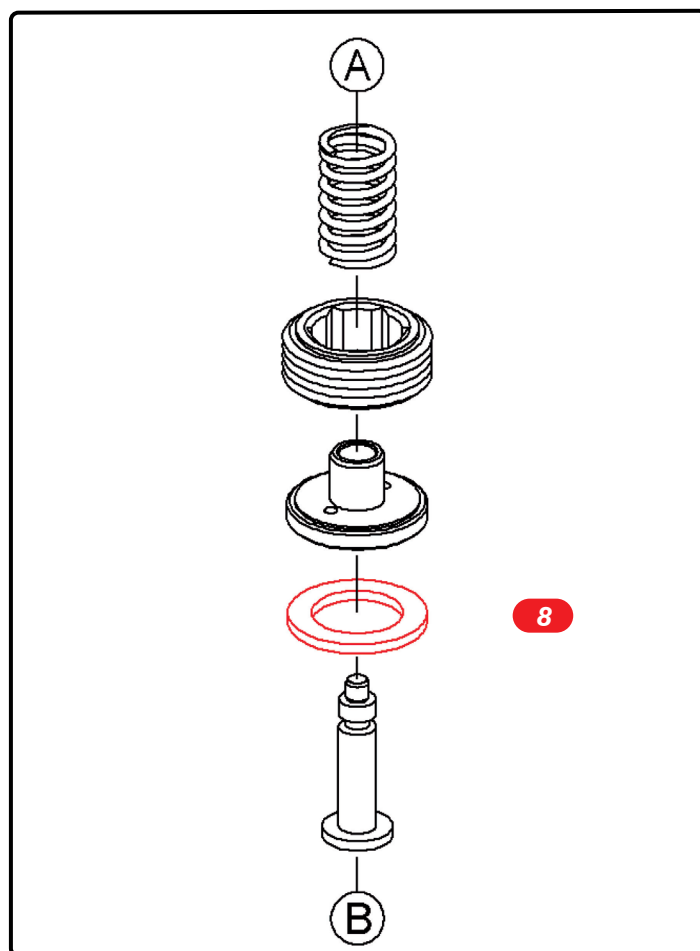
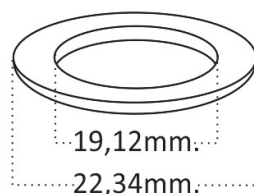

F 00R J00 935	8	1,644 mm
F 00R J00 937	8	1,648 mm
F 00R J00 939	8	1,652 mm
F 00R J00 941	8	1,656 mm
F 00R J00 943	8	1,660 mm
F 00R J00 945	8	1,664 mm
F 00R J00 947	8	1,668 mm
F 00R J00 949	8	1,668 mm
F 00R J00 951	8	1,676 mm
F 00R J00 953	8	1,680 mm
F 00R J00 955	8	1,684 mm

ARANDELAS DE CALIBRACIÓN AH (REDONDAS)

Código	N° Figura	Espesor
Arandela de calibración del cuerpo de Inyector Common Rail - A. Romeo 145 / 146 / 156 1.9 JTD - Citroën Berlingo / Jumpy / Xantia / Xsara Picasso 2.0 HDi - Peugeot / 306 / 406 / Expert / Partner 2.0 Hdi - M. Benz C 200 Cdi / E 200 Cdi / A160 Cdi / A 170 Cdi. - Iveco Dayli - Chevrolet Captiva - Fiat Bravo / Stilo / Ducato - Kia Sportage - Inyectores 0 445 110 002 - 008 - 009 - 010 - 011 - 012 - 014 - 015 - 019 - 020 - 044 - 244 - 268 - 269 - 276 - 410		
F 00V C10 400	8	1,190 mm
F 00V C10 402	8	1,194 mm
F 00V C10 404	8	1,198 mm
F 00V C10 406	8	1,202 mm
F 00V C10 408	8	1,206 mm
F 00V C10 410	8	1,210 mm
F 00V C10 412	8	1,214 mm
F 00V C10 414	8	1,218 mm
F 00V C10 416	8	1,222 mm
F 00V C10 418	8	1,226 mm
F 00V C10 420	8	1,230 mm
F 00V C10 422	8	1,234 mm
F 00V C10 424	8	1,238 mm
F 00V C10 426	8	1,242 mm
F 00V C10 428	8	1,246 mm
F 00V C10 430	8	1,250 mm
F 00V C10 432	8	1,254 mm
F 00V C10 434	8	1,258 mm
F 00V C10 436	8	1,262 mm
F 00V C10 438	8	1,266 mm
F 00V C10 440	8	1,270 mm
F 00V C10 442	8	1,274 mm
F 00V C10 444	8	1,278 mm
F 00V C10 446	8	1,282 mm
F 00V C10 448	8	1,286 mm
F 00V C10 450	8	1,290 mm
F 00V C10 452	8	1,294 mm

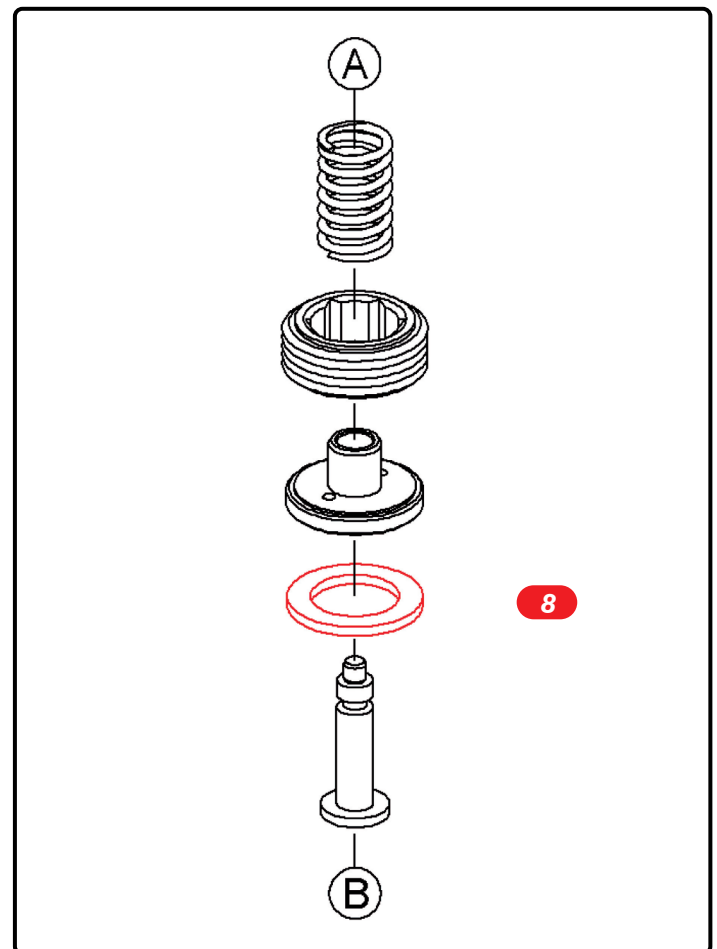
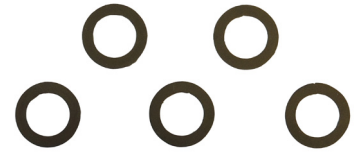
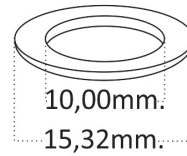

ARANDELAS DE CALIBRACIÓN AG (REDONDAS)

Código	Nº Figura	Espesor
Arandela de calibración del cuerpo de Inyector - A. Romeo 145 / 146 / 156 1.9 JTD - Citroën Berlingo / Jumpy / Xantia / Xsara Picasso 2.0Hdi - Peugeot/306 / 406 / Expert / Partner 2.0 Hdi - M. Benz C 200 Cdi / E 200 Cdi / A160 Cdi / A 170 Cdi. - Iveco Dayli - Chevrolet Captiva - Fiat Bravo / Stilo / Ducato - Kia Sportage - Inyectores 0 445 110 002 - 008 - 009 - 010 - 011 - 012 - 014 - 015 - 019 - 020 - 044 - 244 - 268 - 269 - 276 - 410		
F 00V C60 243	23	0,996 mm
F 00Z C99 335	23	1,000 mm
F 00Z C99 336	23	1,007 mm
F 00Z C99 337	23	1,008 mm
F 00Z C99 338	23	1,012 mm
F 00Z C99 339	23	1,016 mm
F 00Z C99 340	23	1,020 mm
F 00Z C99 341	23	1,024 mm
F 00V C60 259	23	1,028 mm
F 00V C60 261	23	1,032 mm
F 00V C60 263	23	1,036 mm
F 00V C60 265	23	1,040 mm
F 00V C60 267	23	1,044 mm
F 00V C60 269	23	1,048 mm
F 00V C60 271	23	1,052 mm
F 00V C60 273	23	1,056 mm
F 00V C60 275	23	1,060 mm
F 00V C60 277	23	1,064 mm
F 00V C60 279	23	1,068 mm
F 00V C60 281	23	1,072 mm
F 00V C60 283	23	1,076 mm
F 00V C60 285	23	1,080 mm
F 00V C60 287	23	1,084 mm
F 00V C60 289	23	1,088 mm
F 00V C60 291	23	1,092 mm
F 00V C60 293	23	1,096 mm
F 00V C60 295	23	1,100 mm
F 00V C60 297	23	1,104 mm
F 00V C60 299	23	1,108 mm
F 00V C60 301	23	1,112 mm
F 00V C60 303	23	1,116 mm

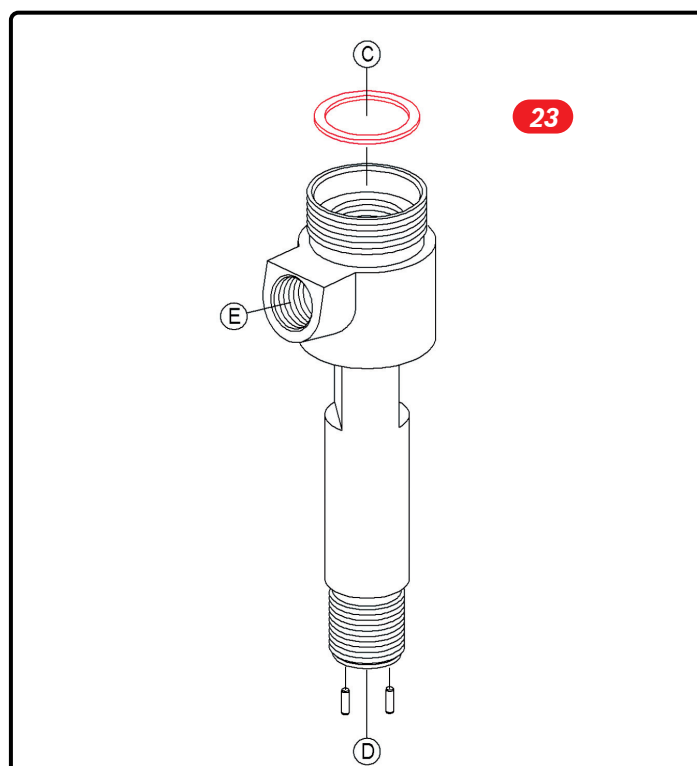
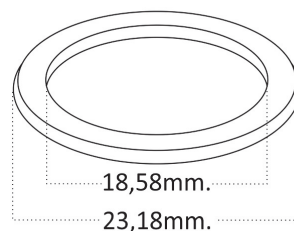

F 00V C60 305	23	1,120 mm
F 00V C60 307	23	1,124 mm
F 00V C60 309	23	1,128 mm
F 00V C60 311	23	1,132 mm
F 00V C60 313	23	1,136 mm
F 00V C60 315	23	1,140 mm
F 00V C60 317	23	1,144 mm
F 00V C60 319	23	1,148 mm
F 00V C60 321	23	1,152 mm
F 00V C60 323	23	1,156 mm
F 00V C60 325	23	1,160 mm
F 00V C60 327	23	1,164 mm
F 00V C60 329	23	1,168 mm
F 00V C60 331	23	1,172 mm
F 00V C60 335	23	1,180 mm

ARANDELAS DE CALIBRACIÓN VSF

Código	Nº Figura	Espesor
Arandela de calibración del cuerpo de Inyector Common Rail - A. Romeo 145 / 146 / 156 1.9 JTD - Citroën Berlingo / Jumpy / Xantia / Xsara Picasso 2.0HDi - Peugeot / 306 / 406 / Expert / Partner 2.0 Hdi - M. Benz C 200 Cdi / E 200 Cdi / A160 Cdi / A 170 Cdi. - Iveco Dayli - Chevrolet Captiva - Fiat Bravo / Stilo / Ducato - Kia Sportage - Inyectores 0 445 110 002 - 008 - 009 - 010 - 011 - 012 - 014 - 015 - 019 - 020 - 044 - 244 - 268 - 269 - 276 - 410		
F 00V C60 574	25	1,24 mm
F 00V C60 576	25	1,26 mm
F 00V C60 578	25	1,28 mm
F 00V C60 580	25	1,30 mm
F 00V C60 582	25	1,32 mm
F 00V C60 584	25	1,34 mm
F 00V C60 586	25	1,36 mm
F 00V C60 588	25	1,38 mm
F 00V C60 590	25	1,40 mm
F 00V C60 592	25	1,42 mm
F 00V C60 594	25	1,44 mm
F 00V C60 596	25	1,46 mm
F 00V C60 598	25	1,48 mm
F 00V C60 600	25	1,50 mm
F 00V C60 602	25	1,52 mm
F 00V C60 604	25	1,54 mm
F 00V C60 606	25	1,56 mm
F 00V C60 608	25	1,58 mm
F 00V C60 610	25	1,60 mm
F 00V C60 612	25	1,62 mm
F 00V C60 614	25	1,64 mm
F 00V C60 616	25	1,66 mm
F 00V C60 618	25	1,68 mm
F 00V C60 620	25	1,70 mm
F 00V C60 622	25	1,72 mm
F 00V C60 624	25	1,74 mm
F 00V C60 626	25	1,76 mm
F 00V C60 628	25	1,78 mm
F 00V C60 630	25	1,80 mm
F 00V C60 632	25	1,82 mm
F 00V C60 634	25	1,84 mm

4,60mm.



2,38mm.

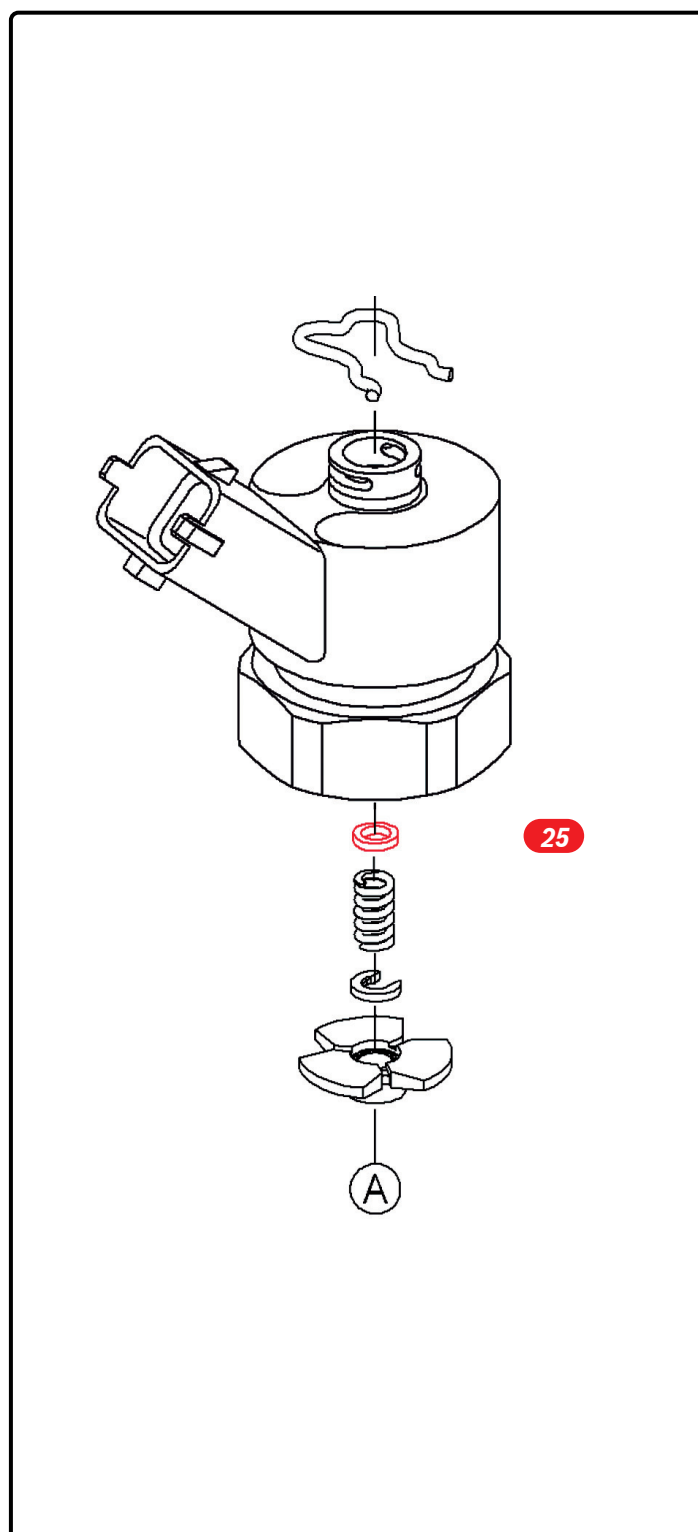

ARANDELAS DE CALIBRACIÓN VSF

Código	Nº Figura	Reemplaza a:	Espesor
Arandela de calibración del grupo magnético Citroën Jumper 2.8HDI - Peugeot Boxer 2.8 HDI - Iveco Daily 35 C - Renault Premium - Volkswagen 15 /180 electrónico motor Agrale - Deutz con motor MWM - Inyectores 0445120120 / 125 / 140 / 173 / 208 / 231 / 238 / 075 / 089 / 092 / 114 / 002 / 003 / 012 / 014 / 019 / 028 / 043 / 059 / 060 / 062 / 063 / 066.			
F 00R J00 772	25		0,94 mm
F 00R J00 775	25		0,97 mm
F 00R J00 778	25		1,00 mm
F 00R J00 781	25		1,03 mm
F 00R J00 784	25		1,06 mm
F 00R J00 787	25		1,09 mm
F 00R J00 790	25		1,12 mm
F 00R J04 654	25	F 00R J00 793	1,15 mm
F 00R J00 796	25		1,18 mm
F 00R J00 799	25		1,21 mm
F 00R J00 802	25		1,24 mm
F 00R J00 805	25		1,27 mm
F 00R J00 808	25		1,30 mm
F 00R J00 811	25		1,33 mm
F 00R J00 814	25		1,36 mm
F 00R J00 817	25		1,39 mm
F 00R J00 820	25		1,42 mm
F 00R J00 823	25		1,45 mm
F 00R J01 834	25		1,48 mm
F 00R J01 837	25		1,51 mm
F 00R J01 840	25		1,54 mm
F 00R J01 843	25		1,57 mm
F 00R J01 846	25		1,60 mm

3,76mm.



2,00mm.

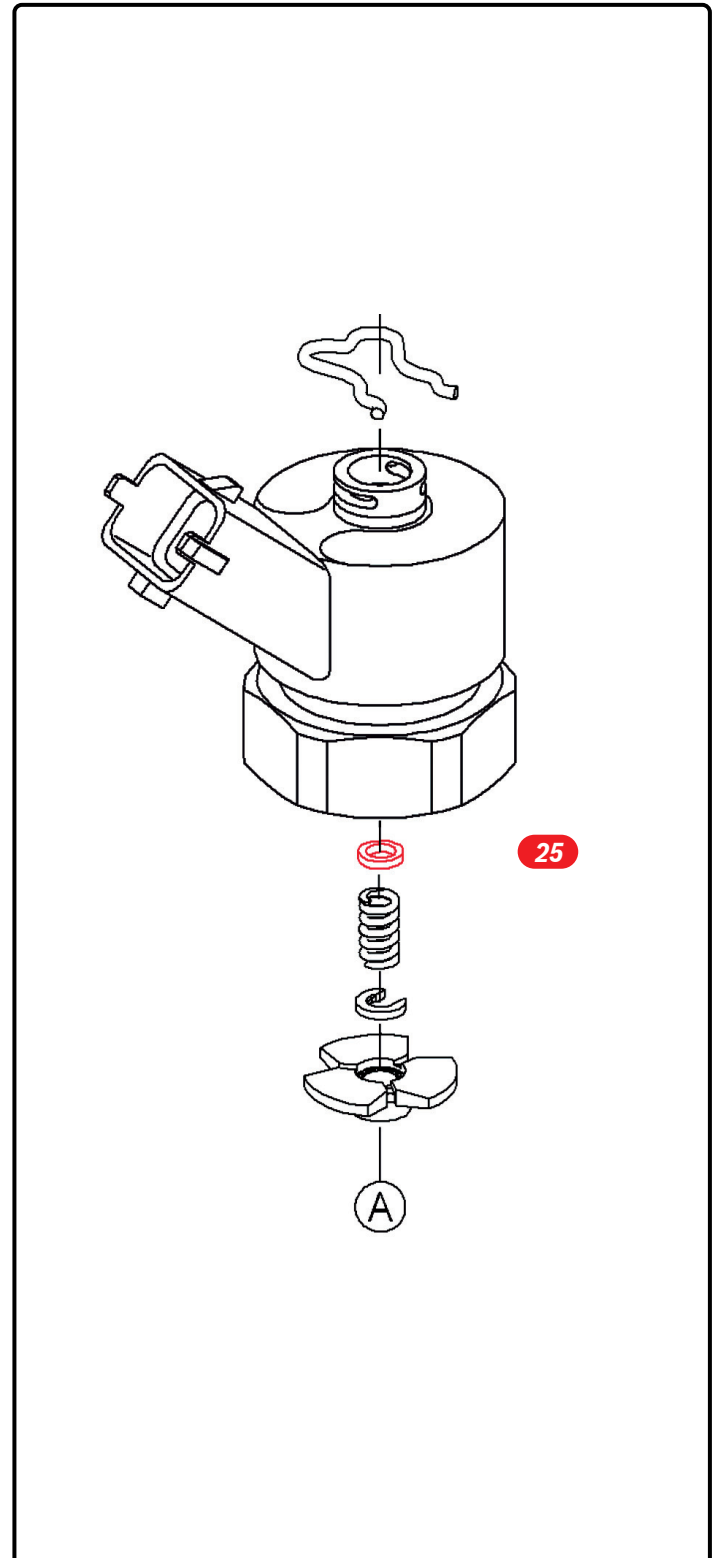

ARANDELAS DE CALIBRACIÓN VSF

Código	N° Figura	Espesor
Arandela de calibración del grupo magnético - Peugeot 206 / 307 - M. Benz Vito / Viano / C 200 / C 2200 - Citroën C4 / Xsara / Ford Focus / Renault laguna / Megane / Scenic - Honda CRV / Civic - Mercedes Benz 160 / 180 / 200 / Vito / Viano - Inyectores 0 445 110 075 / 139 / 176 / 188 / 230 / 288 / 323		
F 00V C60 485	25	1,40 mm
F 00V C60 487	25	1,42 mm
F 00V C60 489	25	1,44 mm
F 00V C60 491	25	1,46 mm
F 00V C60 493	25	1,48 mm
F 00V C60 495	25	1,50 mm
F 00V C60 497	25	1,52 mm
F 00V C60 499	25	1,54 mm
F 00V C60 501	25	1,56 mm
F 00V C60 503	25	1,58 mm
F 00V C60 505	25	1,60 mm
F 00V C60 507	25	1,62 mm
F 00V C60 509	25	1,64 mm
F 00V C60 511	25	1,66 mm
F 00V C60 513	25	1,68 mm
F 00V C60 515	25	1,70 mm
F 00V C60 517	25	1,72 mm
F 00V C60 519	25	1,74 mm
F 00V C60 521	25	1,76 mm
F 00V C60 523	25	1,78 mm
F 00V C60 525	25	1,80 mm
F 00V C60 527	25	1,82 mm
F 00V C60 529	25	1,84 mm
F 00V C60 531	25	1,86 mm
F 00V C60 533	25	1,88 mm
F 00V C60 535	25	1,90 mm

4,00mm.



2,00mm.

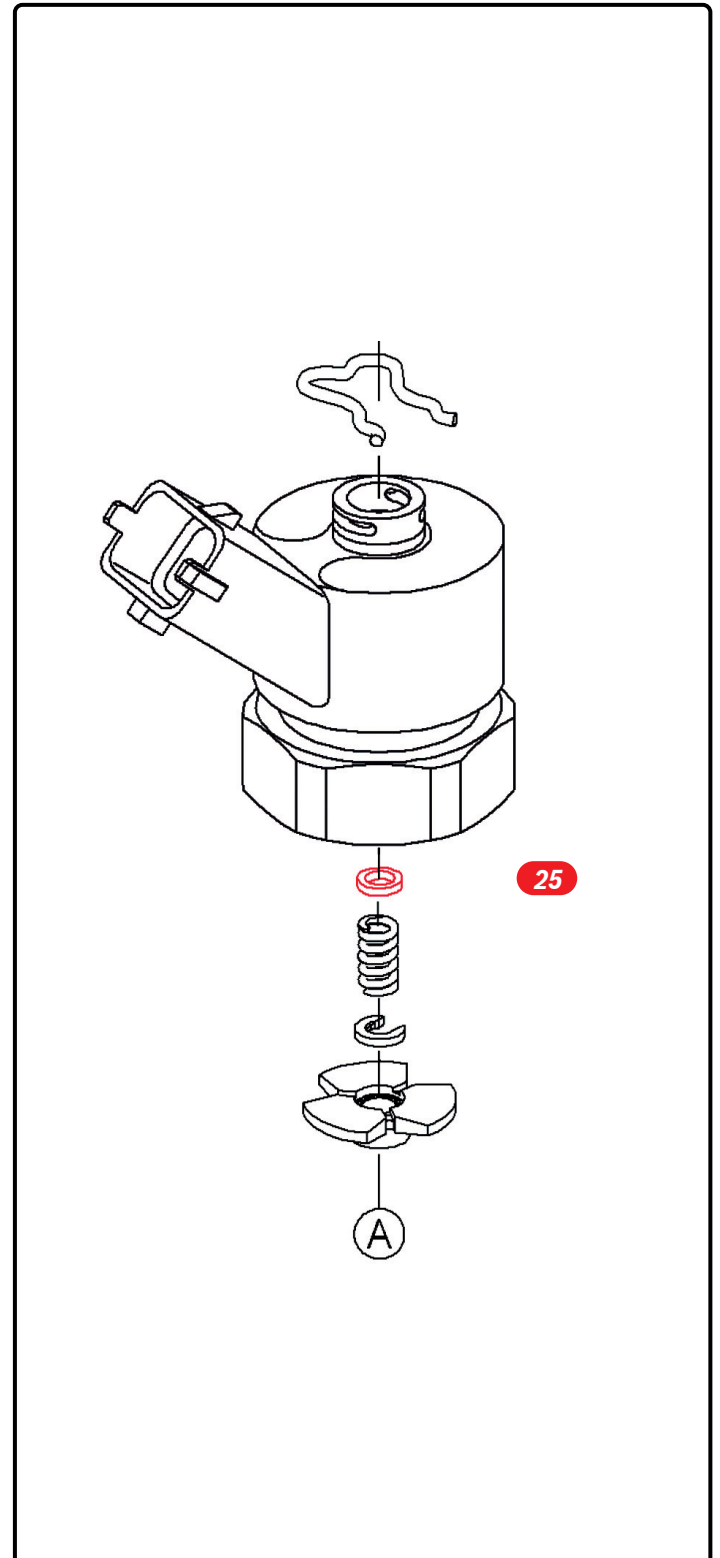

ARANDELAS DE CALIBRACIÓN VSF

Código	N° Figura	Espesor
Arandela de calibración del grupo magnético - Peugeot 206 / 307 - Citroën C4 / Xsara / Ford Focus / Renault laguna / Megane / Scenic - Honda CRV / Civic - M. Benz 160 / 180 / 200 / Vito / Viano / C 200 / C 2200 - Inyectores 0 445 110 075 / 139 / 176 / 188 / 230 / 288 / 323		
F 00V C60 386	47	1,089 mm
F 00V C60 389	47	1,098 mm
F 00V C60 392	47	1,107 mm
F 00V C60 395	47	1,116 mm
F 00V C60 398	47	1,125 mm
F 00V C60 401	47	1,134 mm
F 00V C60 404	47	1,143 mm
F 00V C60 407	47	1,152 mm
F 00V C60 410	47	1,161 mm
F 00V C60 413	47	1,170 mm
F 00V C60 416	47	1,179 mm
F 00V C60 419	47	1,188 mm
F 00V C60 422	47	1,197 mm
F 00V C60 425	47	1,206 mm
F 00V C60 428	47	1,215 mm
F 00V C60 431	47	1,224 mm
F 00V C60 434	47	1,233 mm
F 00V C60 437	47	1,242 mm
F 00V C60 440	47	1,251 mm
F 00V C60 443	47	1,260 mm
F 00V C60 446	47	1,269 mm
F 00V C60 449	47 </td <td>1,278 mm</td>	1,278 mm
F 00V C60 452	47	1,287 mm
F 00V C60 455	47	1,296 mm
F 00V C60 458	47	1,305 mm
F 00V C60 461	47	1,314 mm
F 00V C60 464	47	1,323 mm
F 00V C60 467	47	1,332 mm
F 00V C60 470	47	1,341 mm
F 00V C60 473	47	1,350 mm
F 00V C60 476	47	1,359 mm
F 00V C60 479	47	1,368mm

5,96mm.

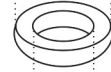

2,00mm.

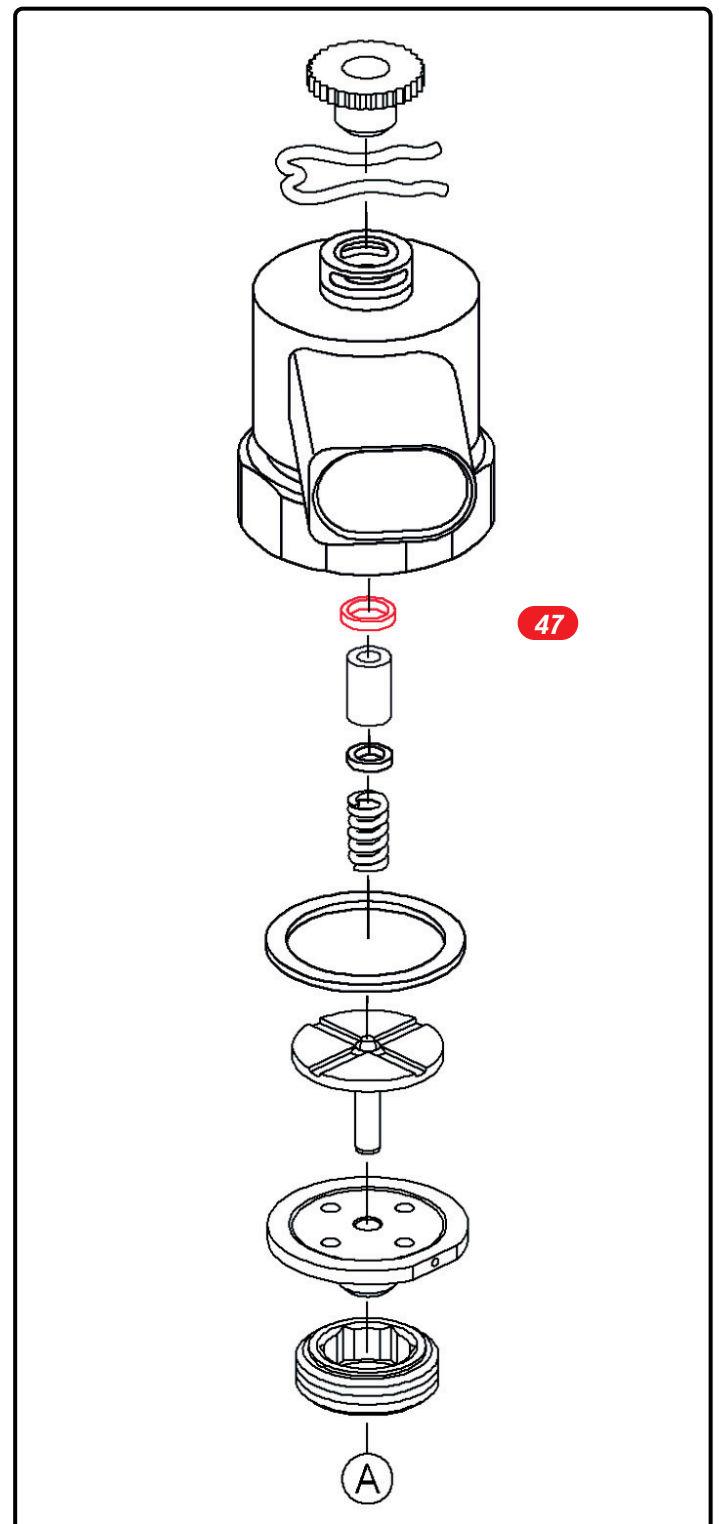

ARANDELAS DE CALIBRACION VSF - CRIN 1-14/16

Código	N° Figura	Espesor
Arandelas de calibracion del grupo magnetico, Peugeot Boxer 2.8, Fiat Ducato 2.8, Renault Inyector 0 445 120 002. Iveco Tector Ford, Vw 13170, Vw 15170 inyector 0 445 120 007, 012, 014, 028, 043.		
F 00R J04 225	47	0,985 mm
F 00R J04 226	47	0,995 mm
F 00R J04 227	47	1,005 mm
F 00R J04 228	47	1,015 mm
F 00R J04 229	47	1,025 mm
F 00R J04 230	47	1,035 mm
F 00R J04 231	47	1,045 mm
F 00R J04 232	47	1,055 mm
F 00R J04 233	47	1,065 mm
F 00R J04 234	47	1,075 mm
F 00R J04 235	47	1,085 mm
F 00R J04 236	47	1,095 mm
F 00R J04 237	47	1,105 mm
F 00R J04 238	47	1,115 mm
F 00R J04 239	47	1,125 mm
F 00R J04 240	47	1,135 mm
F 00R J04 241	47	1,145 mm

7,14mm.



4,08mm.

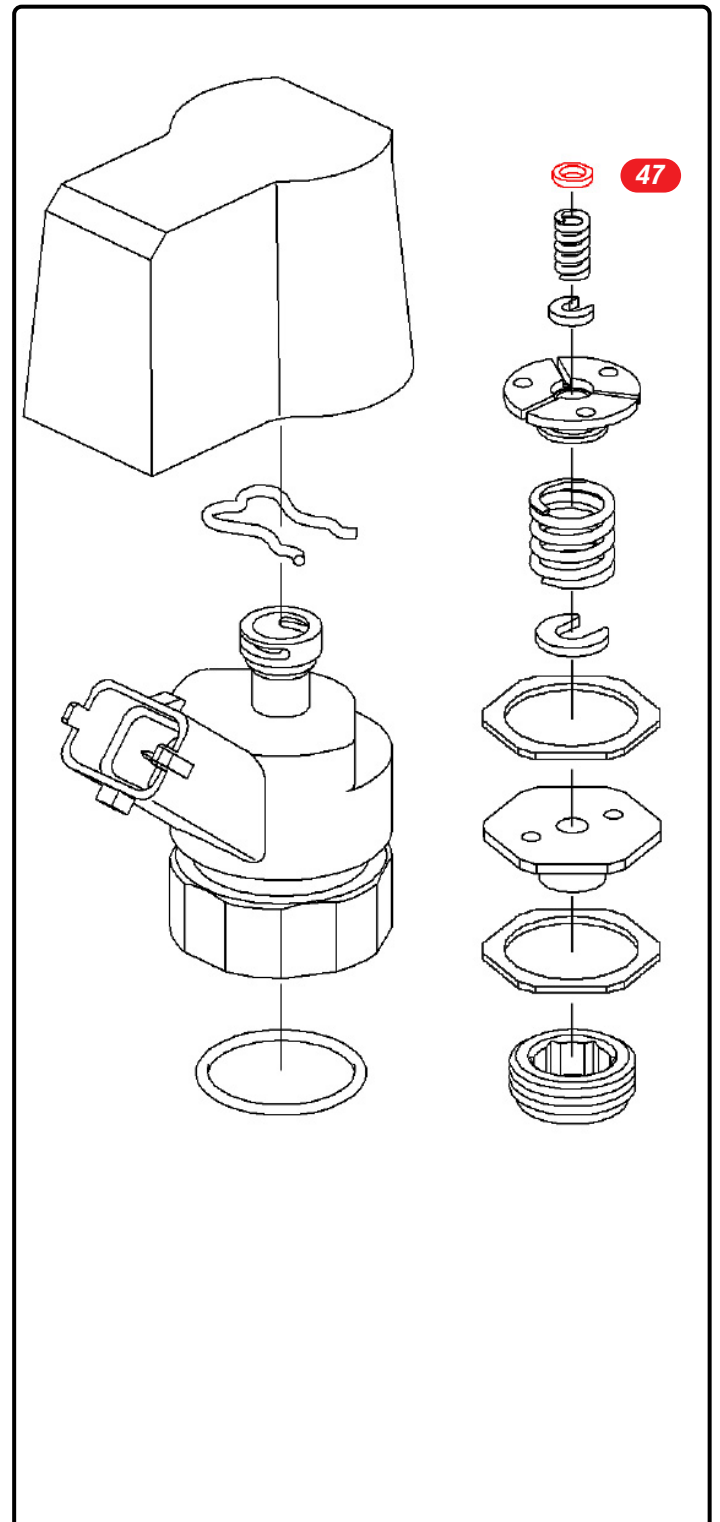

ARANDELAS DE CALIBRACIÓN OT

Código	N° Figura	Espesor
Aarandela de calibración de seguridad del plato de inducidos, Inyector Common Rail BMW 118 / 325 / 525 Fiat Punto 1.3 MJTD 16v - Idea 1.9 JTD 8V - Fiat Stilo 1.9 JTD 16v - A. Romeo 147 / 156 1.9 JTDM 16V - Inyectores 0 445 110 083 - 183 - 187 - 209		
F 00V C18 300	14	1,155 mm
F 00V C18 302	14	1,165 mm
F 00V C18 304	14	1,175 mm
F 00V C18 306	14	1,185 mm
F 00V C18 308	14	1,195 mm
F 00V C18 310	14	1,205 mm
F 00V C18 312	14	1,215 mm
F 00V C18 314	14	1,225 mm
F 00V C18 316	14	1,235 mm
F 00V C18 318	14	1,245 mm
F 00V C18 320	14	1,255 mm
F 00V C18 322	14	1,265 mm

5,00mm.



2,38mm.

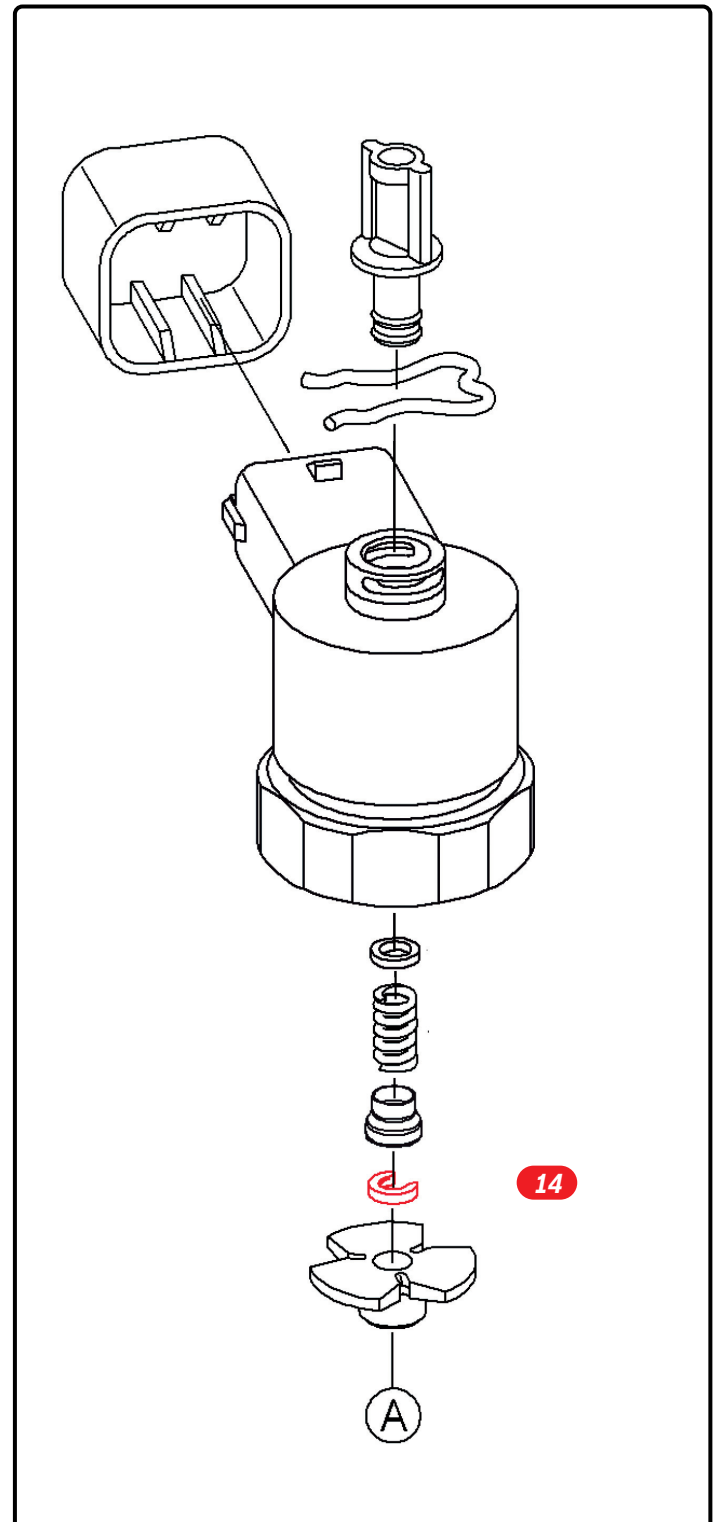

ARANDELAS DE CALIBRACIÓN VSF

Código	Nº Figura	Reemplaza a:	Espesor
Arandela de calibración de apoyo resorte de tobera, Inyector Common Rail - A. Romeo 145 1,9 JTD - Fiat Brava 1,9 JTD - Citroën Berlingo 2,0 HDI - Inyectores Cri 0 445 110 002 -008 -009 -010 -011 -012 -014 -015 -021 -022 -023 -024 -025.			
F 00V C10 570	25	F 00V C10 460	1,00 mm
F 00V C10 578	25	F 00V C10 468	1,08 mm
F 00V C10 580	25	F 00V C10 470	1,10 mm
F 00V C10 582	25	F 00V C10 472	1,12 mm
F 00V C10 584	25	F 00V C10 474	1,14 mm
F 00V C10 586	25	F 00V C10 476	1,16 mm
F 00V C10 588	25	F 00V C10 478	1,18 mm
F 00V C10 590	25	F 00V C10 480	1,20 mm
F 00Z C99 068	25	F 00V C10 592	1,22 mm
F 00Z C99 069	25	F 00V C10 594	1,24 mm
F 00V C10 596	25	F 00V C10 486	1,26 mm
F 00V C10 598	25	F 00V C10 488	1,28 mm
F 00V C10 600	25	F 00V C10 490	1,30 mm
F 00V C10 602	25	F 00V C10 492	1,32 mm
F 00Z C99 074	25	F 00V C10 604	1,34 mm
F 00V C10 606	25	F 00V C10 496	1,36 mm
F 00V C10 608	25	F 00V C10 498	1,38 mm
F 00V C10 610	25	F 00V C10 500	1,40 mm
F 00V C10 612	25	F 00V C10 502	1,42 mm
F 00V C10 614	25	F 00V C10 504	1,44 mm
F 00V C10 616	25	F 00V C10 506	1,46 mm
F 00V C10 618	25	F 00V C10 508	1,48 mm
F 00V C10 620	25	F 00V C10 510	1,50 mm
F 00V C10 622	25	F 00V C10 512	1,52 mm
F 00V C10 624	25	F 00V C10 514	1,54 mm
F 00V C10 626	25	F 00V C10 516	1,56 mm
F 00V C10 628	25	F 00V C10 518	1,58 mm
F 00V C10 630	25	F 00V C10 520	1,60 mm
F 00V C10 632	25	F 00V C10 522	1,62 mm
F 00V C10 634	25	F 00V C10 524	1,64 mm
F 00V C10 636	25	F 00V C10 526	1,66 mm
F 00V C10 638	25	F 00V C10 528	1,68 mm
F 00V C10 640	25	F 00V C10 530	1,70 mm

4,94mm.

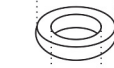

3,14mm.

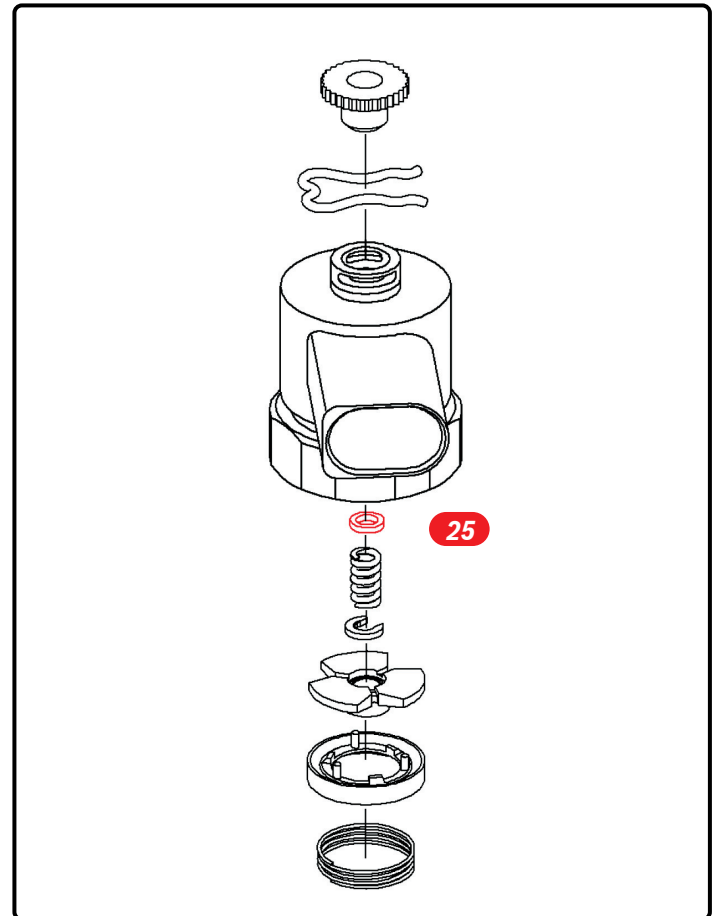

F 00V C10 642	25	F 00V C10 532	1,72 mm
F 00V C10 644	25	F 00V C10 534	1,74 mm
F 00V C10 646	25	F 00V C10 536	1,76 mm
F 00V C10 648	25	F 00V C10 538	1,78 mm
F 00V C10 650	25	F 00V C10 540	1,80 mm
F 00V C10 652	25	F 00V C10 542	1,82 mm
F 00V C10 654	25	F 00V C10 544	1,84 mm
F 00V C10 656	25	F 00V C10 546	1,86 mm
F 00V C10 658	25	F 00V C10 548	1,88 mm
F 00V C10 660	25	F 00V C10 550	1,90 mm
F 00V C10 666	25	F 00V C10 556	1,96 mm
F 00V C10 670	25	F 00V C10 560	2,00 mm

ARANDELAS DE CALIBRACIÓN NSF

Código	N° Figura	Reemplaza a:	Espesor
--------	-----------	--------------	---------

Arandela de calibración del resorte de tobera (NSF). Inyector CRIN 0 445 120 007 Cummins. Inyector CRI 0 454 110 186 Kia Sorento 2.5

F 00V C10 570	16	F 00V C10 460	1,00 mm
F 00V C10 578	16	F 00V C10 468	1,08 mm
F 00V C10 580	16	F 00V C10 470	1,10 mm
F 00V C10 582	16	F 00V C10 472	1,12 mm
F 00V C10 584	16	F 00V C10 474	1,14 mm
F 00V C10 586	16	F 00V C10 476	1,16 mm
F 00V C10 588	16	F 00V C10 478	1,18 mm
F 00V C10 590	16	F 00V C10 480	1,20 mm
F 00Z C99 068	16	F 00V C10 592	1,22 mm
F 00Z C99 069	16	F 00V C10 594	1,24 mm
F 00V C10 596	16	F 00V C10 486	1,26 mm
F 00V C10 598	16	F 00V C10 488	1,28 mm
F 00V C10 600	16	F 00V C10 490	1,30 mm
F 00V C10 602	16	F 00V C10 492	1,32 mm
F 00Z C99 074	16	F 00V C10 604	1,34 mm
F 00V C10 606	16	F 00V C10 496	1,36 mm
F 00V C10 608	16	F 00V C10 498	1,38 mm
F 00V C10 610	16	F 00V C10 500	1,40 mm
F 00V C10 612	16	F 00V C10 502	1,42 mm
F 00V C10 614	16	F 00V C10 504	1,44 mm
F 00V C10 616	16	F 00V C10 506	1,46 mm
F 00V C10 618	16	F 00V C10 508	1,48 mm
F 00V C10 620	16	F 00V C10 510	1,50 mm
F 00V C10 622	16	F 00V C10 512	1,52 mm
F 00V C10 624	16	F 00V C10 514	1,54 mm
F 00V C10 626	16	F 00V C10 516	1,56 mm
F 00V C10 628	16	F 00V C10 518	1,58 mm
F 00V C10 630	16	F 00V C10 520	1,60 mm
F 00V C10 632	16	F 00V C10 522	1,62 mm
F 00V C10 634	16	F 00V C10 524	1,64 mm
F 00V C10 636	16	F 00V C10 526	1,66 mm
F 00V C10 638	16	F 00V C10 528	1,68 mm
F 00V C10 640	16	F 00V C10 530	1,70 mm

4,94mm.



3,14mm.

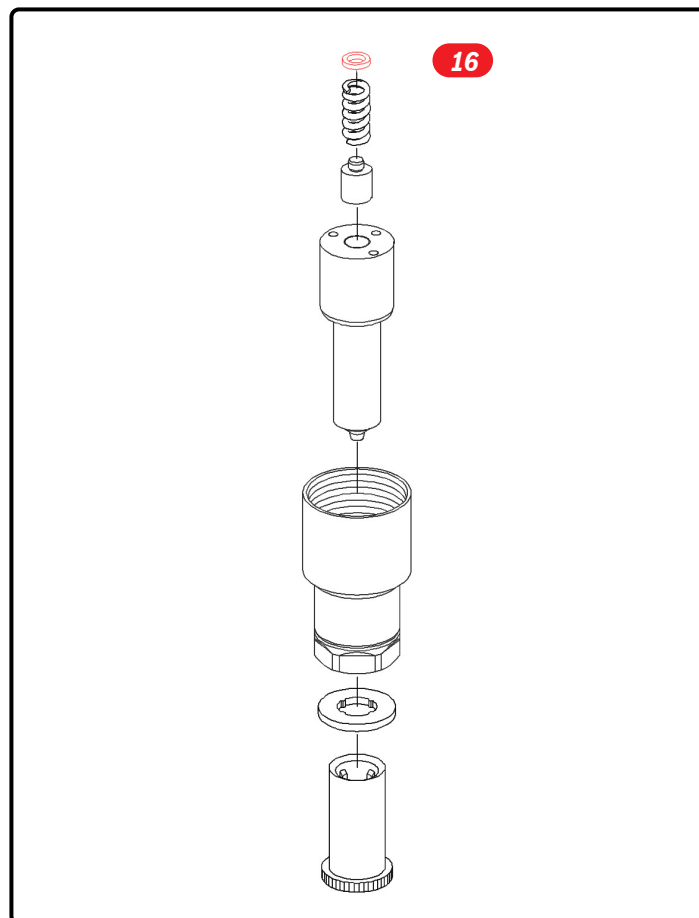

F 00V C10 642	16	F 00V C10 532	1,72 mm
F 00V C10 644	16	F 00V C10 534	1,74 mm
F 00V C10 646	16	F 00V C10 536	1,76 mm
F 00V C10 648	16	F 00V C10 538	1,78 mm
F 00V C10 650	16	F 00V C10 540	1,80 mm
F 00V C10 652	16	F 00V C10 542	1,82 mm
F 00V C10 654	16	F 00V C10 544	1,84 mm
F 00V C10 656	16	F 00V C10 546	1,86 mm
F 00V C10 658	16	F 00V C10 548	1,88 mm
F 00V C10 660	16	F 00V C10 550	1,90 mm
F 00V C10 666	16	F 00V C10 556	1,96 mm
F 00V C10 670	16	F 00V C10 560	2,00 mm

ARANDELAS DE CALIBRACIÓN

Código	Nº Figura	Reemplaza a:	Espesor
Arandela de calibración inferior para platillo de inducido 0.985 mm New Holland cosechadora motor Iveco - Cosechadora Case Serie 800 - Camión Volkswagen Constellation con motor MWM - Volvo 210 con motor MWM. Agrale - Deutz con motor Cummins - Iveco Eurocargo Inyectores 0445120002 / 003 / 007 / 012 / 019 / 028 / 043 / 059 / 060 / 062 / 063 / 066 / 075 / 089 / 092 / 114 / 120 / 125 / 140 / 173 / 208 / 231 / 005.			
F 00R J01 008	27		0,985 mm
F 00R J01 009	27		0,995 mm
F 00R J01 010	27		1,005 mm
F 00R J01 011	27		1,015 mm
F 00R J01 012	27		1,025 mm
F 00R J01 013	27		1,035 mm
F 00R J01 014	27		1,045 mm
F 00R J01 015	27		1,055 mm
F 00R J01 016	27		1,065 mm
F 00R J04 723	27	F 00R J01 017	1,075 mm
F 00R J01 018	27		1,085 mm
F 00R J01 019	27		1,095 mm
F 00R J01 020	27		1,105 mm
F 00R J01 021	27		1,115 mm
F 00R J01 022	27		1,125 mm
F 00R J01 023	27		1,135 mm
F 00R J01 024	27		1,145 mm

7,18mm.

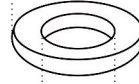

4,14mm.

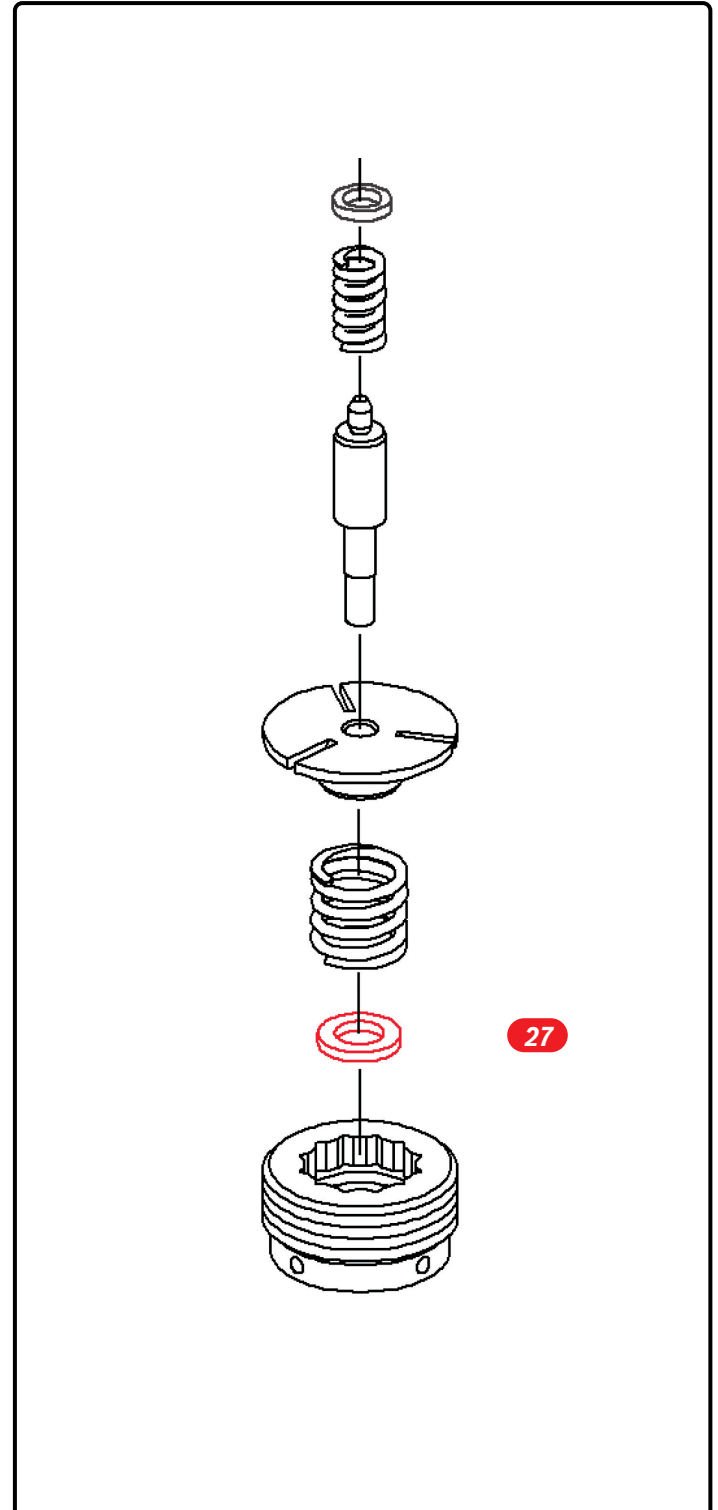
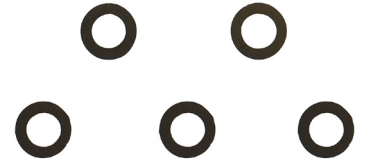

PERNOS DE PRESIÓN NL

Código	Nº Figura	Espesor
Pieza de presión de tobera Inyector Common Raill - A. Romeo 145 1.9 JTD - Citroën Berlingo 2.0 HDI - Peugeot 206 / 306 / 406 / Expert / Partner 2.0 HDI		
F 00V C12 340	18	8,397 mm
F 00V C12 348	18	8,421 mm
F 00V C12 356 Ree. x F 00V C12 456	18	8,445 mm
F 00V C12 364 Ree. x F 00V C12 464	18	8,469 mm
F 00V C12 388 Ree. x F 00V C12 499	18	8,541 mm

Código	Nº Figura	Espesor
Pieza de presión de tobera Inyector Common Raill - M.Benz A160 / 170CDI - 311 / 316 / 308 / 416 CDI Sprinter. Peugeot 206 / 307 1.4		
F 00V C12 400	18	8,277 mm
F 00V C12 404	18	8,289 mm
F 00V C12 408	18	8,301 mm
F 00V C12 412	18	8,313 mm
F 00V C12 416	18	8,325 mm
F 00V C12 420	18	8,337 mm
F 00V C12 424	18	8,349 mm
F 00V C12 428	18	8,361 mm
F 00V C12 432	18	8,373 mm
F 00V C12 436	18	8,385 mm
F 00V C12 440	18	8,397 mm
F 00V C12 444	18	8,409 mm
F 00V C12 448	18	8,421 mm
F 00V C12 452	18	8,433 mm
F 00V C12 456	18	8,445 mm
F 00V C12 460	18	8,457 mm
F 00V C12 464	18	8,469 mm
F 00V C12 468	18	8,481 mm
F 00V C12 472	18	8,493 mm
F 00V C12 476	18	8,505 mm
F 00V C12 480	18	8,517 mm
F 00V C12 484	18	8,529 mm

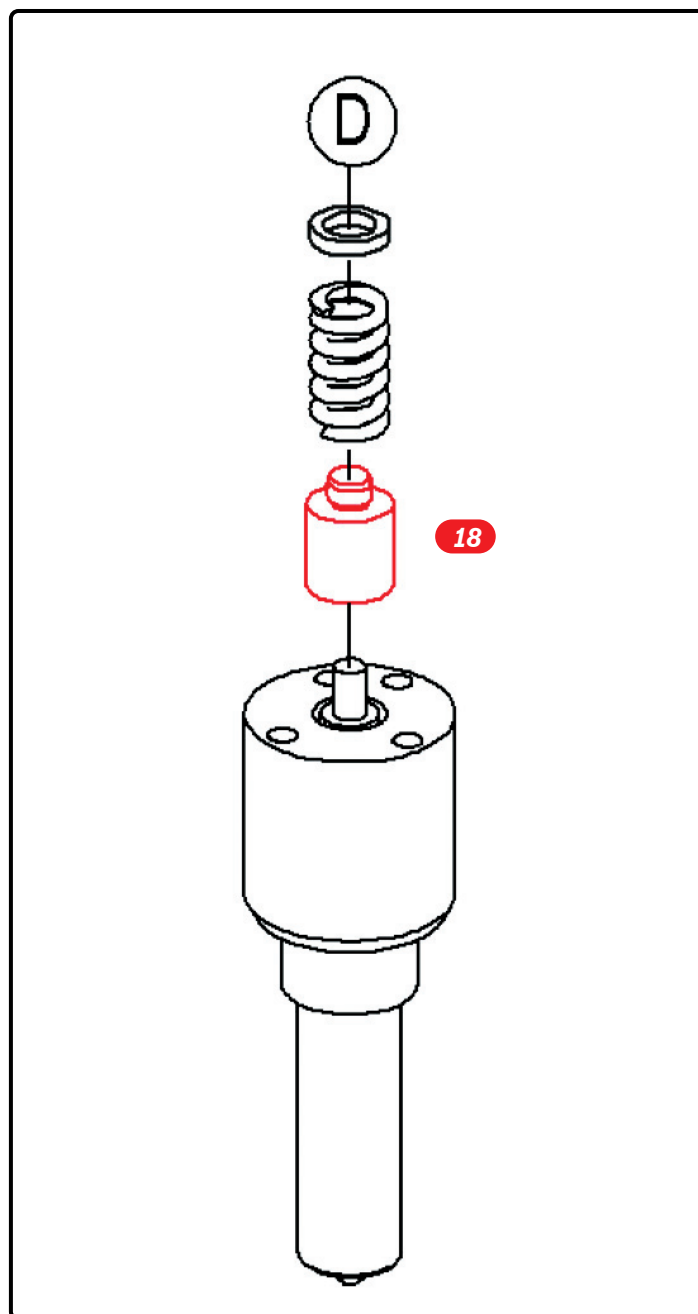

F 00V C12 488	18	8,541 mm
F 00V C12 492	18	8,553 mm
F 00V C12 496	18	8,565 mm
F 00V C12 498	18	8,571 mm

PERNOS DE PRESIÓN NL

Código	N° Figura	Reemolaza a	Espesor
Pieza de presión de tobera Inyector Common Rail - Fiat Palio Weekend 1.9 JTD - Punto 1.9 JTD / BMW 330d - 530 D			
F 00V C12 504	18		1,02 mm
F 00Z C99 111	18	F 00V C12 506	1,03 mm
F 00V C12 508	18		1,04 mm
F 00Z C99 113	18	F 00V C12 510	1,05 mm
F 00Z C99 114	18	F 00V C12 512	1,06 mm
F 00V C12 514	18		1,07 mm
F 00Z C99 116	18	F 00V C12 516	1,08 mm
F 00Z C99 117	18	F 00V C12 518	1,09 mm
F 00V C12 520	18		1,10 mm
F 00V C12 522	18		1,11 mm
F 00V C12 524	18		1,12 mm
F 00V C12 526	18		1,13 mm
F 00Z C99 127	18	F 00V C12 528	1,14 mm
F 00V C12 530	18		1,15 mm
F 00V C12 532	18		1,16 mm
F 00V C12 534	18		1,17 mm
F 00V C12 536	18		1,18 mm
F 00V C12 538	18		1,19 mm
F 00V C12 540	18		1,20 mm
F 00V C12 542	18		1,21 mm
F 00V C12 546	18		1,23 mm
F 00V C12 548	18		1,24 mm
F 00V C12 550	18		1,23 mm
F 00V C12 554	18		1,23 mm
F 00V C12 556	18		1,28 mm
F 00V C12 558	18		1,23 mm
F 00V C12 560	18		1,23 mm
F 00V C12 562	18		1,23 mm
F 00V C12 564	18		1,32 mm
F 00V C12 572	18		1,36 mm

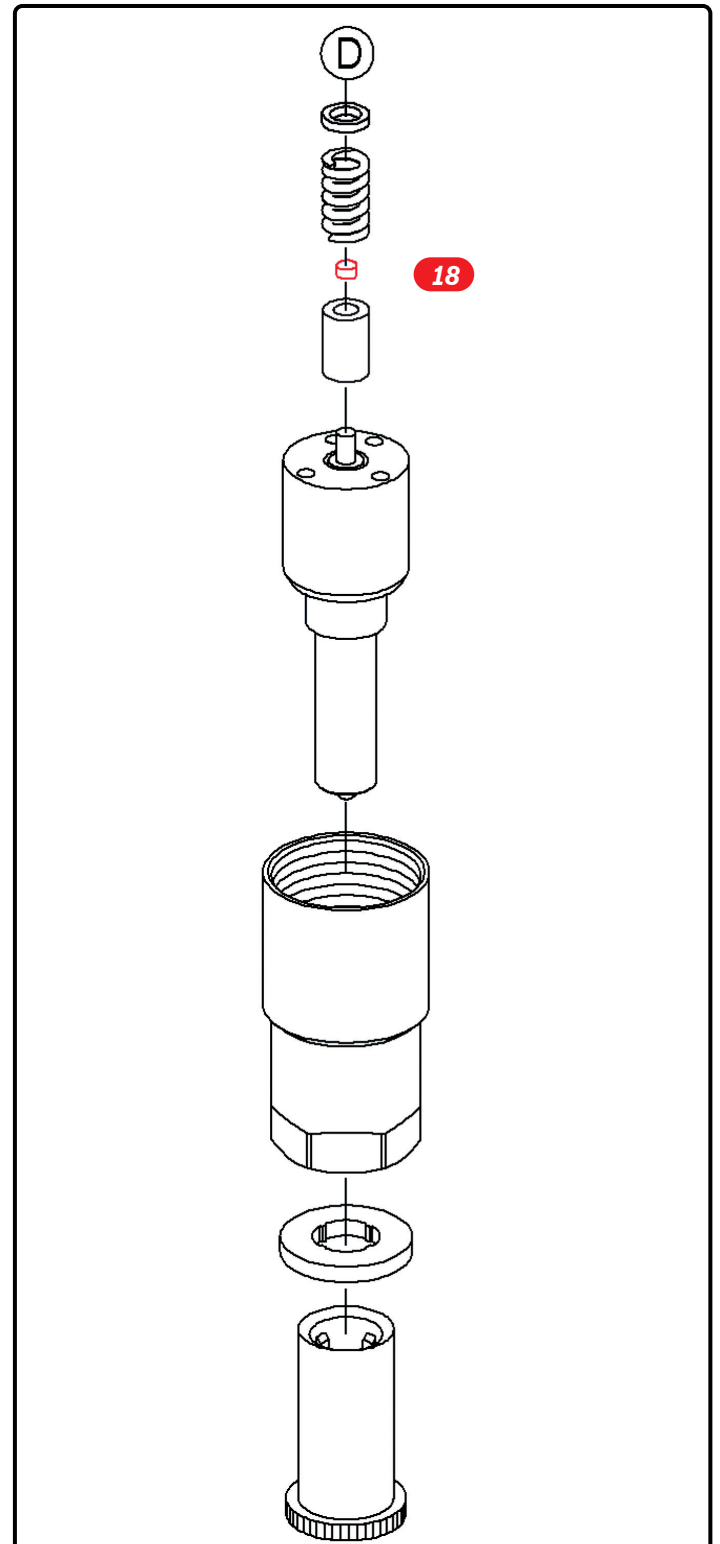

VARIOS

Código	Nº de Pieza	Inyector	Aplicación
F 00V C16 024	22	0 445 110 231 0 445 110 076	Racord de entrada combustible Inyector Common Rail - Fiat Bravo / Marea 1,9 JTD / Punto 1,9 JTD. Blazer S10 - Citroën Berlingo 2,0 HDI.
F 00V C16 027 Ree. x F 00V C16 017	22	0 445 110 189 0 445 110 263	Racord de entrada de combustible Inyector Common Rail - M. Benz A 160 / 170 DCI / E200 / 220 / 270 DCI / Sprinter 211 / 213 / 216 / 313 DCI.
F 00V C40 300	23	0 445 110 131	Casquillo tope de inducido.
F 00R J00 342	32	0 445 120 007	Anillo de seguridad cuerpo inyector Iveco Tector.
F 00R J00 531	727	0 445 120 022 0 445 120 074	Racord de montaje de cánula Common Rail IPL For Cargo 1830. Renault Midlum, Premium.
F 00R J00 849	35	0 445 120 007 0 445 120 016	Soporte de prisionero de grupo magnético de Inyector Common Rail IPL - VW 15.180 / 15.190 / 17.210 / 17.230 EOD Electronic.
F 00R J01 481	22	0 445 120 062	Racord de entrada de combustible Common Rail Sisu.

ARANDELAS VARIAS

Código	Nº de Pieza	Inyector	Aplicación
F 00V C17 002	21	0 445 110 047 - 068 - 127	Arandela de racord de empalme Inyector Common Rail - Renault Megane 1.9 DCI - BMW 330d - 530d. A. Romeo 156 / 166.
F 00V C17 003	21	0 445 110 047 - 068 - 127	Arandela de racord de Inyector Common Rail en general.
F 00V C17 503	750	0 445 110 008 - 036 - 076 / 0 445 120 007	Arandela de asiento de Inyector BMW 318d - Dodge Ram 2500 5,9. Citroën Berlingo, Xara, Peugeot 206, 306, 406, Partner.
F 00V C17 504	750	0 445 110 002 - 244	Arandela de asiento de Inyector Common Rail - Citroën C3 1,6 HDI - Fiat Punto 109 JTD - A. Romeo 156 SW 1,9 JTD / 166 / Spider, Ford Fiesta, Focus, Peugeot 207 / 208 / 308 / Partner.

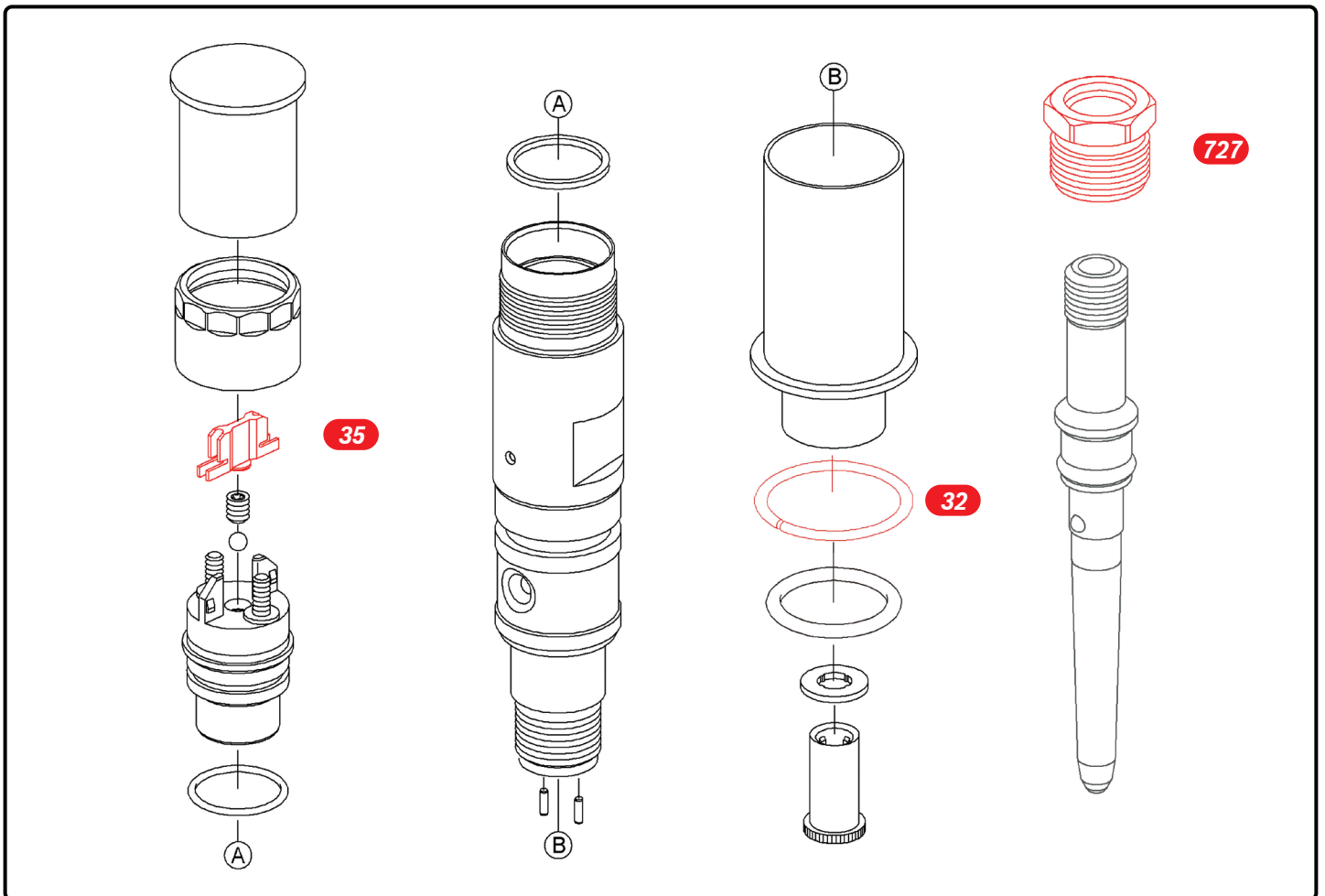
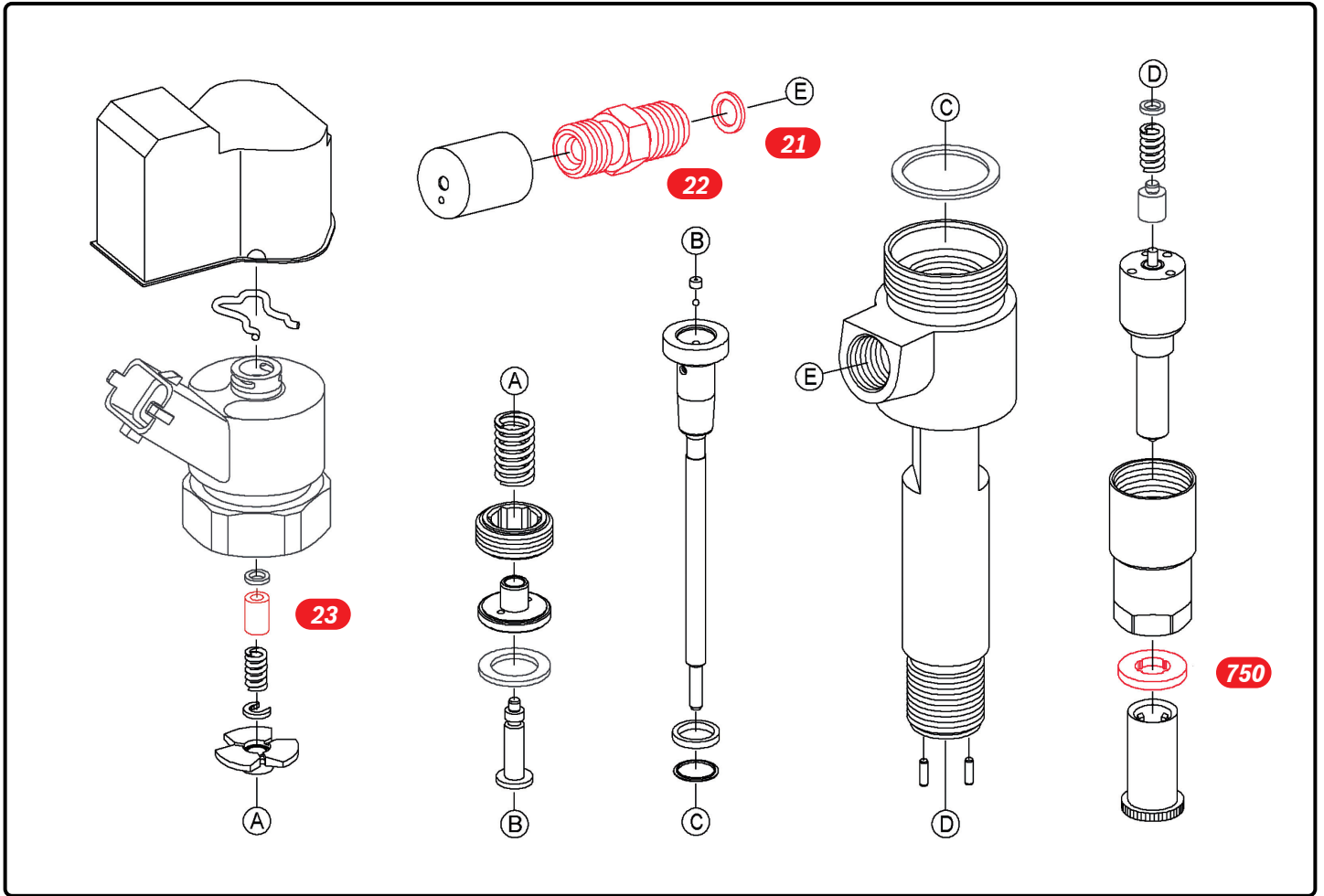

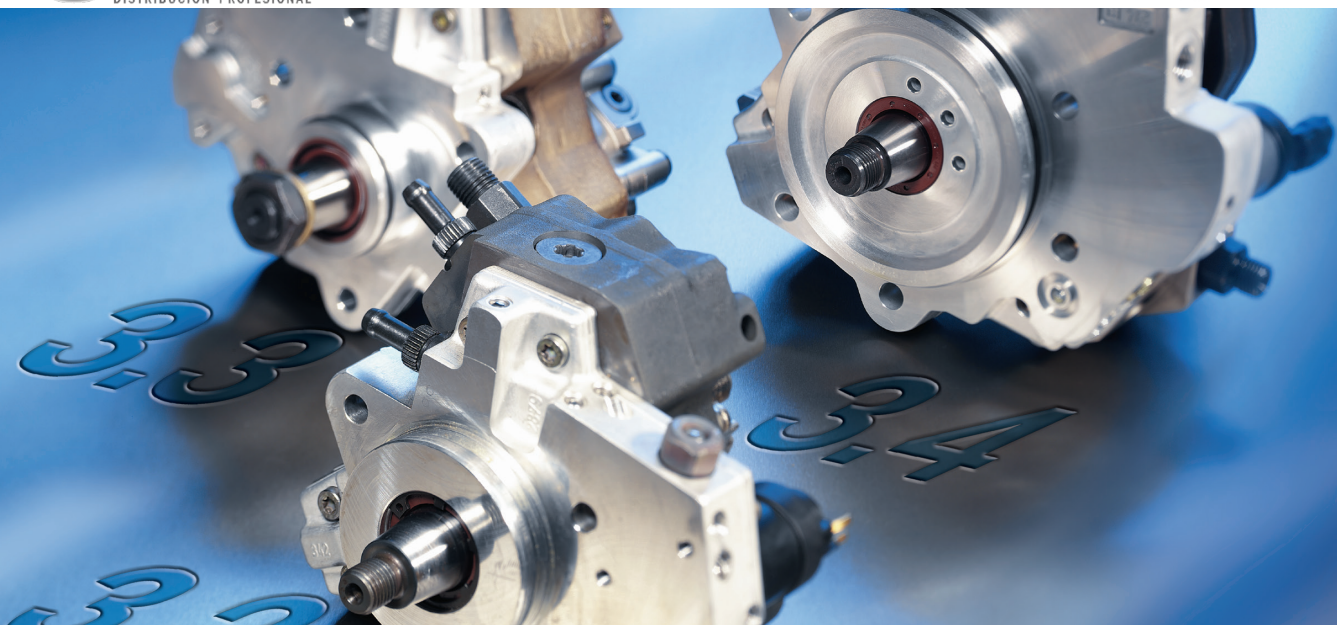

BOMBAS DE ALTA PRESIÓN

BOMBAS COMPLETAS

Código	Aplicación
0 445 010 008	Bomba alta presión - M. Benz 208 / 211 / 213 / 308 / 311 / 313 / 408 DCI Sprinter - 0986437003.
0 445 010 010	Bomba alta presión - Peugeot - Citroën 2.0 HDI. Reemplaza a 0445010046.
0 445 010 019	Bomba alta presión - M. Benz 216 / 316 / 416 DCI Sprinter.
0 445 010 024	Bomba alta presión - CP1K3 / L60 / 10 6S - M. Benz 408 / 411 / 413 DCI Sprinter, VW 17.260E0T Euro 3. Reemplazado x 0445010272
0 445 010 033	Bomba alta presión - CP3 S 3 - Renault Master 2.2 DCI 90 / 2.5 DCI 120.
0 445 010 034	Bomba alta presión - Common Rail - Cherokee 2.5 TD.
0 445 010 115	Bomba alta presión - CP3 S3 / R110 / 30 / 7895 - Chevrolet S10 - Blazer 2.8 Electrónico.
0 445 010 129	Bomba alta presión - CP1H3 / R80 / 10-895 Nissan Frontier 2.8 Electrónico. Reemplazado x 0445010294.
0 445 010 132	Bomba alta presión - Peugeot 307 2.0 HDI. Reemplazado x 0445010284
0 445 010 157	Bomba alta presión - CP1 H3 / R70 / 10-895 - A. Romeo - Fiat Turín Punto 1.3 MJTD.
0 445 010 259	Bomba alta presión - Chevrolet S10, Blazer 2.8
0 445 010 268	Bomba alta presión - M. Benz Sprinter. Reemplaza a 0445010008 - 5.

Código	Aplicación
0 445 010 271	Bomba alta presión - M. Benz 715 - Sprinter - Accelo c/motor OM 612. Reemplaza a 0445010019.
0 445 010 272	Bomba alta presión - M. Benz 208/211 Sprinter para banco de pruebas.Reemplaza a 0445010024.
0 445 010 284	Bomba alta presión - Peugeot 307 HDI - Reemplaza a 0 445 010 164
0 445 010 293	Bomba alta presión - Chevrolet Aveo 1,3 - Fiat doblo 1,3 - A. Romeo. Reemplaza a 0445010157
0 445 010 294	Bomba alta presión - Nisan Frontier 2,8 - Xterra 2,8 - VW 3,0. Reemplaza a 0445010129
0 445 010 318	Bomba alta presión - Fiat Iveco
0 445 010 507	Bomba alta presión - VW Amarok 2.0 TDI. Reemplazado x 0445010543
0 445 010 543	Bomba alta presión - Audi A3, A4, A5, A6 Q5, TT, VW Amarok, Passat, Tiguan.
0 445 010 546	Bomba alta presión - Volkswagen Amarok - Tiguan - Sirocco - Passat - Golf.
0 445 010 565	Bomba alta presión - Amarok / Vento / Passat / Audi 2.0 TDI
0 445 020 002	Bomba alta presión - Ducato 2,8 JTD - Iveco - 503.
0 445 020 007	Bomba alta presión - Ford Cargo - F250 - Volkswagen - Deutz - Cummins. Reemplazado x 0445020175.
0 445 020 033	Bomba alta presión - CP3 S 3 / L70 / 20-7895 - Chevrolet Blazer 2.8 D. Electrónica. VW Bus 17.260 EOT.
0 445 020 034	Bomba alta presión - CP3 S3 / R70 / 20 / 7895 - Diesel Cherokee.
0 445 020 035	Bomba alta presión - CP2 Renault 270 / 320 Premium.
0 445 020 043	Bomba alta presión - CP3 S3 / L110 / 30 / 7895 - Komatsu.
0 445 020 054	Bomba alta presión - Cosechadora Sisu 8,4 2007=>
0 445 020 093	Bomba alta presión - Tractor Case magnum c/motor Iveco.
0 445 020 122	Bomba alta presión VW motor Cummins.
0 445 020 151	Bomba alta presión - Ford 750 XTL Super Duty 4x2 motor Cummins
0 445 020 175	Bomba alta presión - Iveco Tector - Ford Cargo C1317E / C1517E / C1722E / F250, VW, Deutz, Cummins. Reemplaza a 0445020007
0 445 020 610	Bomba alta presión - Cosechadora Massey - Ferguson 9690/9790/ Trac 7600/8600 - Motor Sisu.

DESPIECE DE BOMBAS CR | ELEMENTOS

Código	Nº de Pieza	Nº de Bomba	Aplicación
F 00R 0P0 582	20	0 445 010 155	Elemento de Bomba CP3 Chevrolet S10, Blazer.
F 01M 101 349	4	0 445 010 008 0 445 010 013 0 445 010 024 0 445 010 027 0 445 010 253	Elemento de Bomba Common Rail CP1K3 / L60 / 10-S A. Romeo - Fiat 2.4 JTD - M. Benz. 208 / 211 / 213 / 308 / 311 / 313 DCI Sprinter. Reemplaza a F01M101457 / F01M101345 / F00ROP1684 / F01M100075.
2 469 403 352	6	0 445 020 024	Elemento de Bomba CP2 Renault Midlum, Premium, Iveco.

:: CULATAS

Código	Nº de Pieza	Nº de Bomba	Aplicación
F 00R 0P1 709	803		Tapa de elemento de bomba Common Rail - M. Benz. Accelo 715 c/ motor OM612.
F 00R 0P1 731	803	0 445 010 015 - 024 Bomba CP1K	Tapa de elemento de bomba Common Rail - M. Benz. Sprinter.
F 00R 0P1 732	803	0 445 010 006 - 010	Tapa de elemento de bomba Common Rail - Fiat - Peugeot - Renault - Chevrolet - Citroën.
F 00R 0P1 733	803	0 445 010 009 - 021 - 028 - Bomba CPIS	Tapa de elemento de bomba Common Rail - BMW 330d - 330xd - 530d - Citroën C5 2.2 Hdi - Peugeot 406 2.2 Hdi - 607 2.2 Hdi.
F 00R 0P1 734	803	0 445 010 014 - 019 - 030 - 038	Tapa de elemento de bomba Common Rail - M. Benz Sprinter 216 / 316 / 416 DCI, Kia Sportage.
F 00R 0P1 737	803	0 445 010 010	Tapa de elemento de bomba Common Rail - Common Rail Fiat - Peugeot - Renault.
F 00R 0P1 739	803	0 445 010 024	Tapa de elemento de bomba Common Rail - M. Benz. Sprinter 311.
F 00R 0P1 183	803		Tapa de elemento de bomba Common Rail - A. Romeo 156 2.4 JTD.
F 00R 0P1 758	803		Tapa de elemento de bomba Common Rail - M. Benz Sprinter 413 DCI.
F 01M 100 553	5	0 445 010 123 - 137	Tapa de elemento de bomba Common Rail - A. Romeo 159 2.4 JTDM 20V - 166 2.4 JTDM - 147 1.9 JTDM - 156 1.9 JTDM. Spider, Fiat Ducato
F 01M 100 927	5	0 445 010 150 - 180 - 181 - 222 - 247	Tapa de elemento de bomba Common Rail - Fiat Ducato 2.3 JTD. A. Romeo, Daewo, Iveco Daily, Opel Corsa.
F 01M J00 102 Ree. x F 01M 100 927	5	F01M100927	Tapa de elemento de bomba Common Rail - Common Rail - Peugeot 307 1.6 Brak HDI SW.
F 01M J00 087 Ree. x F 01M 100 553	5	F01M100553	Tapa de elemento de bomba Common Rail - Nissan Frontier 2.8 D.Electronic. A. Romeo 159/166/Spider, Fiat Ducato 2.3.

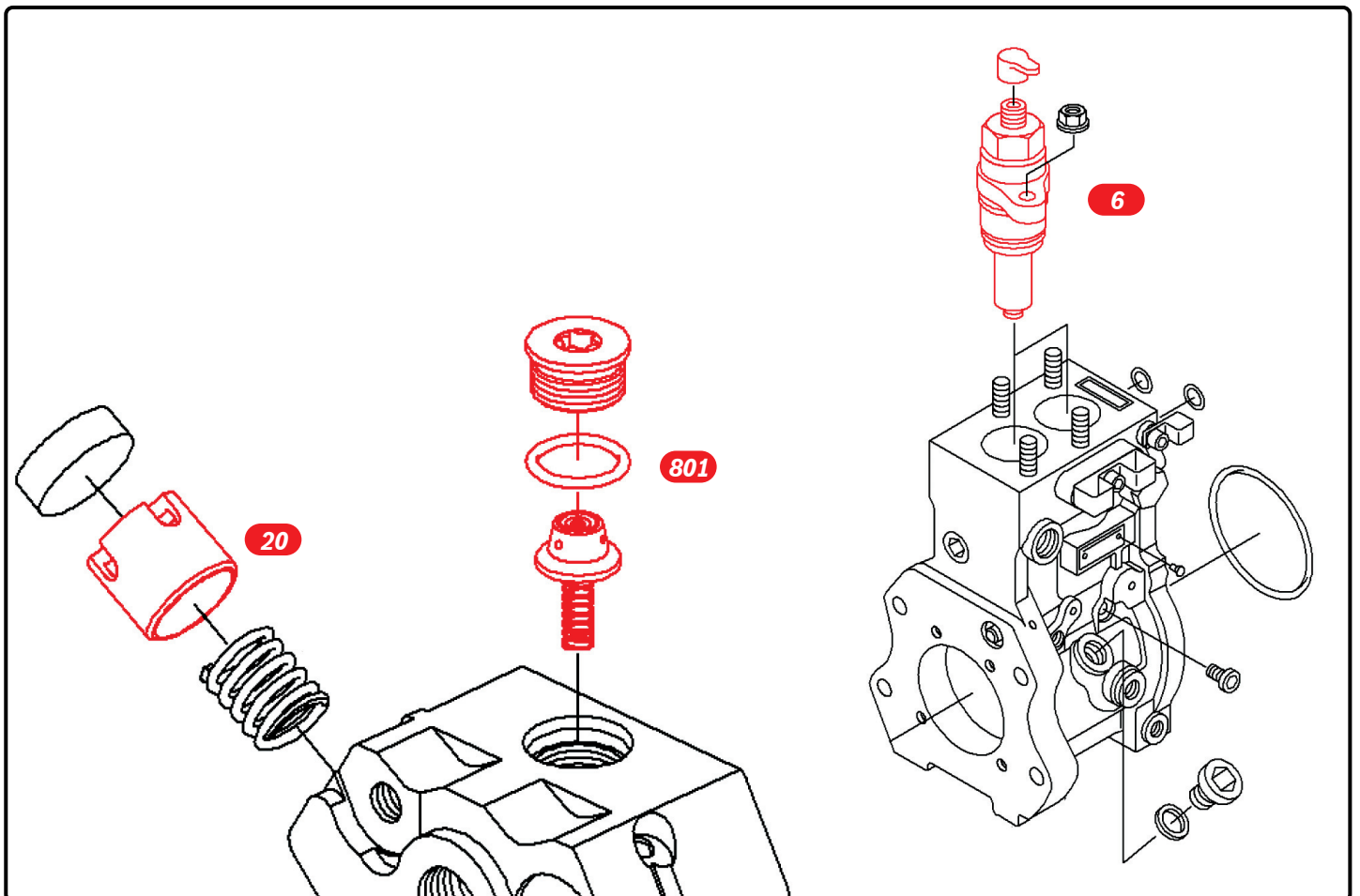
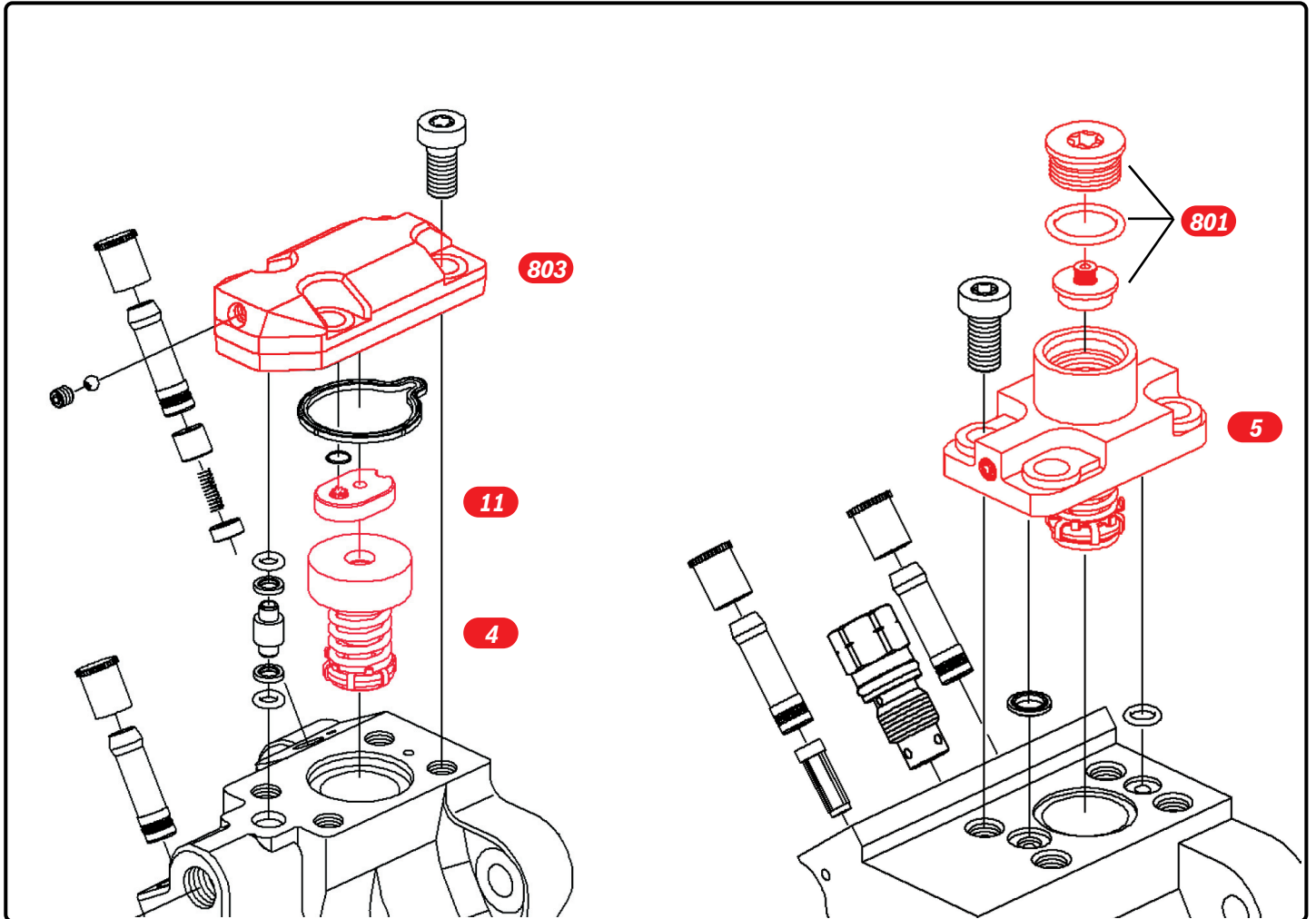

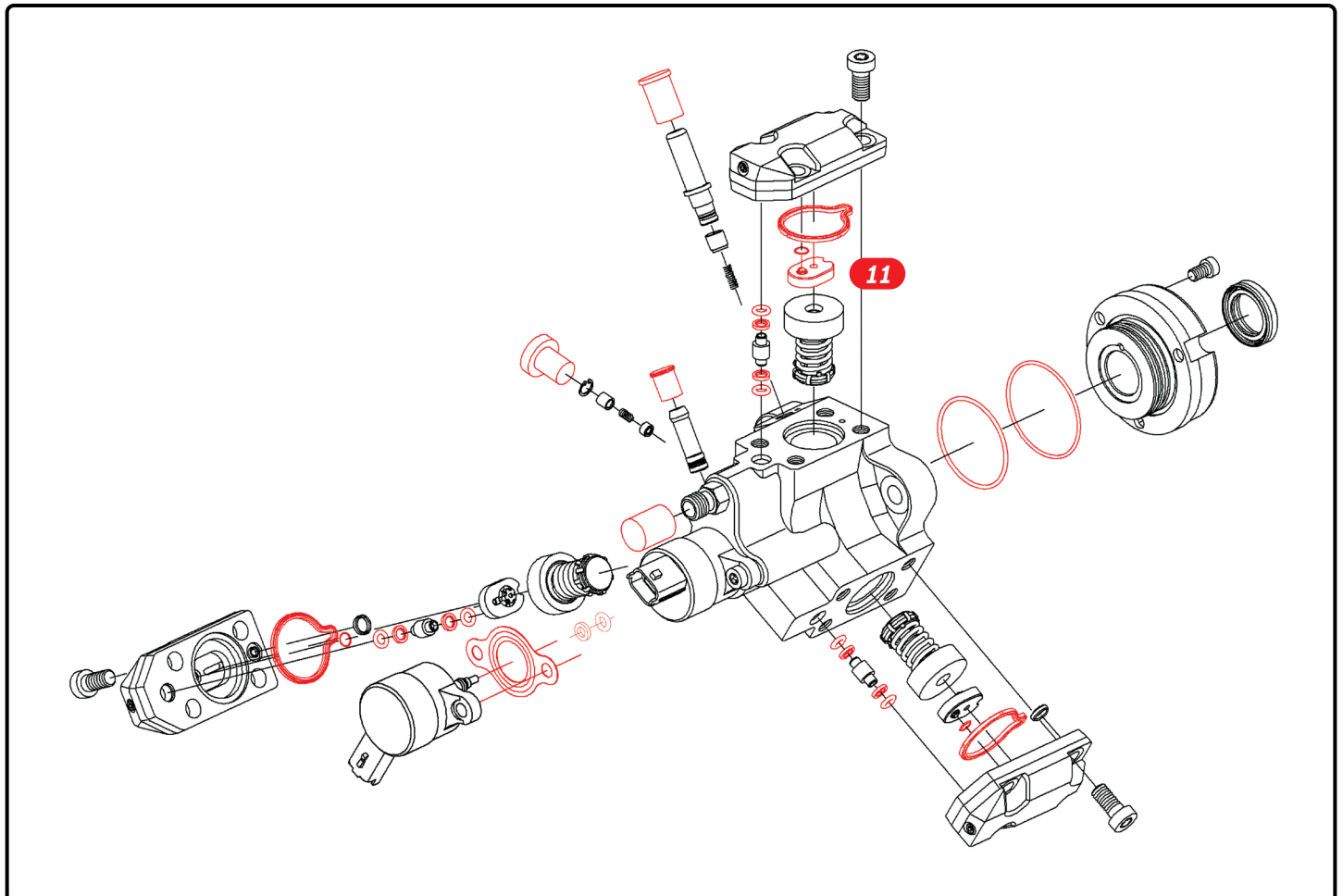
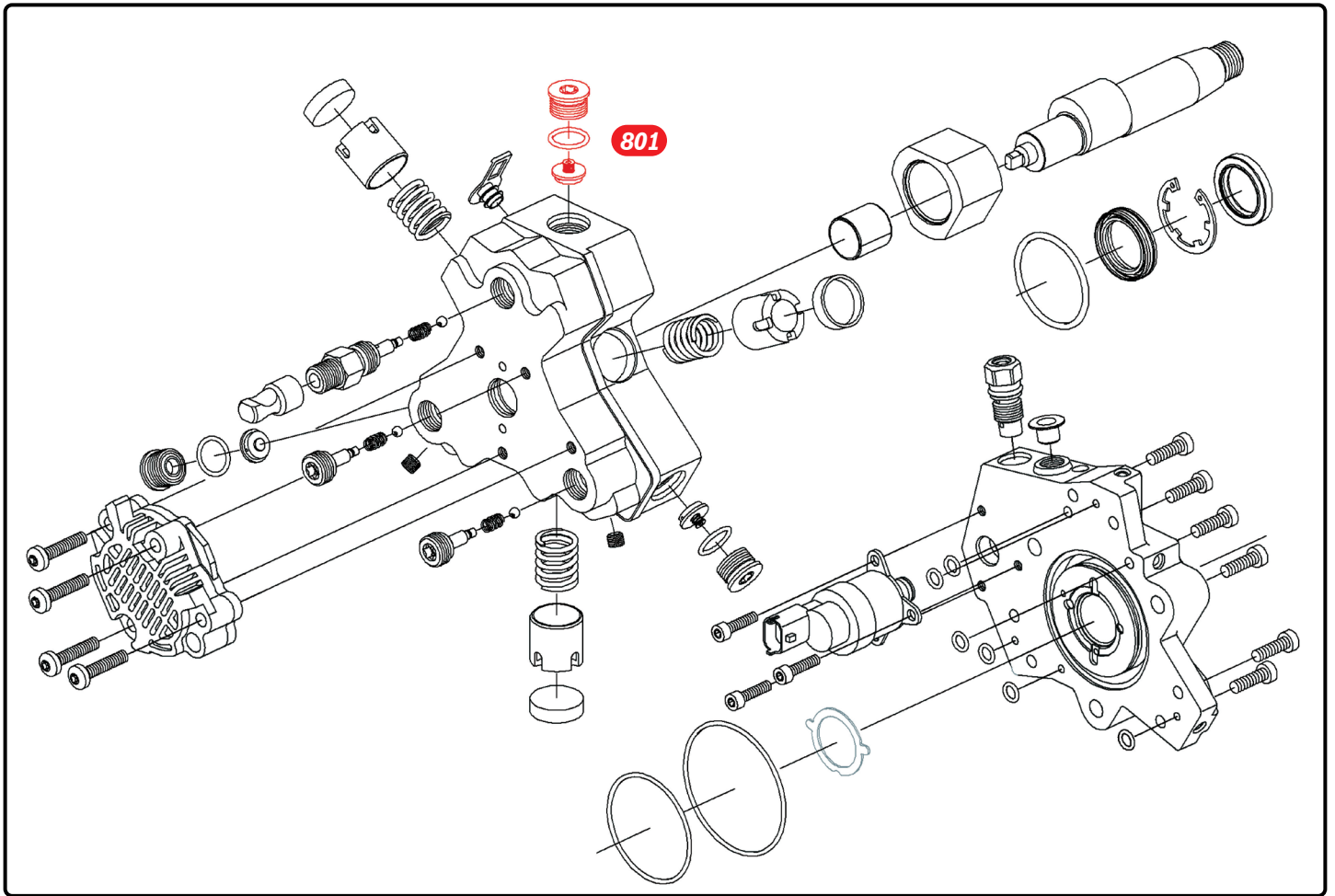

VÁLVULAS DE ASPIRACIÓN | GRUPO INYECTOR

Código	Nº de Pieza	Nº de Bomba	Aplicación	
F 00N 200 993	801	0 445 020 007	Juego de piezas válvulas bomba CP3 - Renault Master 3.0 dci 140 - Chevrolet Blazer 2.8 D.Electronic - S10 2.8 - Ford Cargo C1317 -1517 - 1722 -2422 -2428 E - Cummins.	
F 00N 200 999	801	0 445 010 073 0 445 010 078	Juego piezas válvulas de aspiración BMW 525D - M. Benz Sprinter	
F 00N 201 451	801	0 445 010 033 0 445 010 042	Juego reparación válvulas Master 2,5DCI c/Mot. G9U 724 - Laguna - Citroën Xara - Peugeot 206, 307.	
F 00N 201 524	801	0 445 010 052 0 445 010 101	Juego de válvulas de aspiración Kia Sorento 2.5 CRDI. Hyundai.	
F 00R 0P1 249	11	0 445 010 010 0 445 010 132	Citroën, Peugeot 2.0	
F 00R 0P1 367	11	0 445 010 009 - 011	Grupo Inyector Common Rail BMW 330 / 525 / 530 / X5- L. Rover - Freelander.	

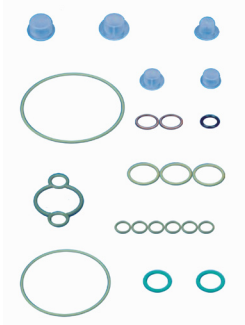
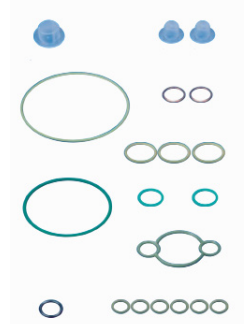
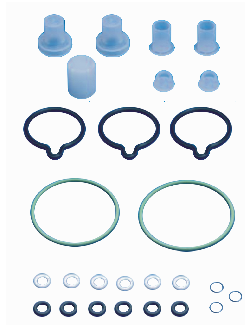

JUEGOS DE JUNTAS

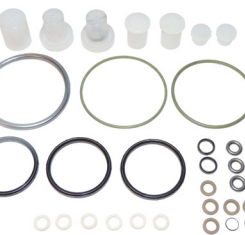
Código	N° de Inyector	Aplicación	
F 00N 201 973	0 445 010 012	Juego juntas bomba CP3 - BMW 740d - Citroën Xsara 1.4 Hdi - Peugeot 206 - 307 1.4 Hdi - Fiat Ducato 10 2.0 JTD - Stilo 1.9 JTD 16v - Dodge Ram.	
F 00N 201 975	0 445 010 012 0 445 020 039	Juego juntas bomba CP3 - BMW 740d - Citroën Xsara 1.4 Hdi - Peugeot 206 - 307 1.4 Hdi - Fiat Ducato 10 2.0 JTD - Stilo 1.9 JTD 16v - Dodge Ram.	
F 01M 101 454	Reparación para CP1H 0 445 010 010	Juego de piezas bomba radial de émbolo Common Rail - A. Romeo 156 / 166 2.4 JTD - Fiat Marea 2.4 JTD - Citroën Berlingo 2.0 / C5 / Jumpi / Xantia / Xsara 2.0 HDI - Peugeot 206 / 306 / 307 / 406 / Expert / Partner 2.0 HDI - Suzuki Gran Vitara 2.0 D.Turbo. Reemplazo a FM100275	
F 01M 101 455	Reparación para CP1 0 445 010 021	Juego de piezas bomba radial de émbolo Common Rail - A. Romeo 156 / 166 2,4 JTD - Fiat Marea 2,4 JTD - BMW 330 / 525 d - Citroën Berlingo / C5 / Juampi / Xantia / Xsara 2,0 HDI. Reemplaza a F01M100276 / Peugeot 406 - Expert.	
F 01M 101 456	Reparación para CP1 0 445 010 038 0 445 010 140	Juego de junta bomba de alta presión VS. Reemplaza a F01M100277. Kia Sportage / Renault Master.	

Código	Aplicación	
F 01M 100 278	Reparación para CP1	Juego juntas Common Rail para válvula reguladora presión - Kia Sportage New 2.0 CRDI.
F 00N 201 977	Reparación para CP3	Juego juntas bomba CP3 - Renault Laguna II 2.2 Dci - Master 2.2 dci 90 - Hyundai H-1 2.5 CRDi - Kia Sorento 2.5 CRDI.

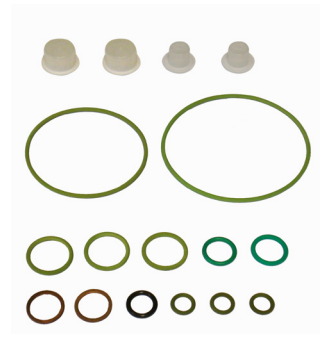

O'RIGNS, JUNTAS Y ANILLOS

Código	Nº de Pieza	Nº de Bomba	Aplicación
F 00R 0P0 085	12	0 445 010 010	O´ring junta de elemento bomba radial de émbolo Common Rail. A. Romeo, Peugeot, Volkswagen, M. Benz Sprinter, Citroën, Peugeot.
F 00R 0P0 480	56	0 445 010 021	O´ring de goma elemento bomba radial de émbolos Common Rail. M. Benz Sprinter 216 - 316 - DCI - Citroën C5 2,2 HDI. Peugeot 406 / 807 / Expert.
F 00R 0P0 577	55	0 445 010 021	O´ring de goma tapa elemento bomba radial de émbolos Common Rail. Peugeot 406 2.2 HDI - Iveco Daily 29 L13.
F 00R 0P1 186 Ree. x F 01M 100 389	14	0 445 010 075	O´ring de goma pieza unión bomba radial de émbolos Common Rail - Citroën Berlingo 2.0 GDI - Peugeot 206 2.0 HDI (F01M100389)
F 00N 201 473	120	0 445 010 135	O´ring chico para brida de bomba de alta presión Common Rail. M. Benz C320 / C350
F 00R 0P0 166	50	0 445 010 015	O´ring de goma brida bomba Common Rail Sprinter - R. Master 2.2 DCI.
F 00R 0P0 743	16	0 445 010 010	O´ring de junta grupo Inyector bomba radial de émbolos Common Rail - Citroën Berlingo 2.0 HDI - Peugeot Partner 2.0 HDI.
F 00R 0P1 106	47	0 445 010 010	O´ring de goma brida bomba radial de émbolos Common Rail - Renault Kangoo I 1.9 DCI - Citroën C5 2.2 HDI - Peugeot Expert 2.0 HDI.
F 00R 0P1 245	55	0 445 010 038	O´ring de goma tapa elemento Common Rail BMW - Land Rover - Kia - Sportage
F 00R 0P1 246	56	0 445 010 038	O´ring de goma elemento Common Rail - BMW - Land Rover - Hyundai - Kia - Sportage
F 00R 0P1 255	10	0 445 010 038	O´ring de goma brida bomba radial de émbolos Common Rail - R. Kangoo I 1.9 DCI - Citroën C5 22 HDI - Peugeot - M. Benz Sprinter - Kia - Sportage
F 00R 0P1 466	18	0 445 010 006	Junta plana de válvula reguladora de presión bomba radial Common Rail - Citroën - Peugeot 206 / 306 / Partner - BMW 330 D - Citroën Berlingo 2.0 HDI
F 00V D38 009 Ree. x F 00N 000 061	17	0 445 010 010	O´ring de válvula reguladora de presión - Hyundai Santa Fe 2.0 CRDI - Peugeot 206 / 306 / Partner.
F 00V D38 011	40	0 445 010 010	Anillo de apoyo válvula reguladora de presión - M. Benz Sprinter 208 / 211 / 213 / 308 / 311 / 313 DCI - Peugeot 206 / 306 / Partner.
F 01M 100 048	47	0 445 010 129	O´ring toroidal Brida de bomba de émbolo Common Rail - Nissan Frontier 2.8 TD.
F 01M 100 049	9	0 445 010 129	O´ring toroidal cuerpo de bomba de émbolo Common Rail - Citroën Berlingo / C3 / C4 / C5 1.6 HDI.
F 01M 100 050	8	0 445 010 129	O´ring CP1 K de tapa de culata bomba radial de émbolo Common Rail - Nissan Frontier - X Terra 2.8 Diesel Electronic.
F 01M 100 055	91	0 445 010 097 (B. Radial) Pieza Nº 63	Junta plana válvula dosificadora Common Rail - Citroën Berlingo / C3 / C4 / C5 HDI.
F 01M 100 114	50	0 445 010 129	O´ring CP1 K de brida bomba radial de émbolo Common Rail - Hyundai H1 2.5 CRDI Cargo - Nissan Frontier 2.8 D. Electronic.
F 01M 100 371	10	0 445 010 129	O´ring CP1 K toroidal cuerpo exterior de bomba de émbolo Common Rail - Nissan Frontier 2.8.

Código	Nº de Pieza	Nº de Bomba	Aplicación
F 01M 100 389	14	0 445 010 010	O´ring de union perno de culata bba. CP1 Peugeot, Citroën 2.0
F 01M 100 599	77	0 445 010 129	Anillos CP1 H de junta bomba radial de émbolo Common Rail - Hyundai H1 2.5 CRDI Cargo - Nissan Frontier 2.8 D. Electronic.
F 01M 101 537	77	0 445 010 129	Anillo junta racord empalme.

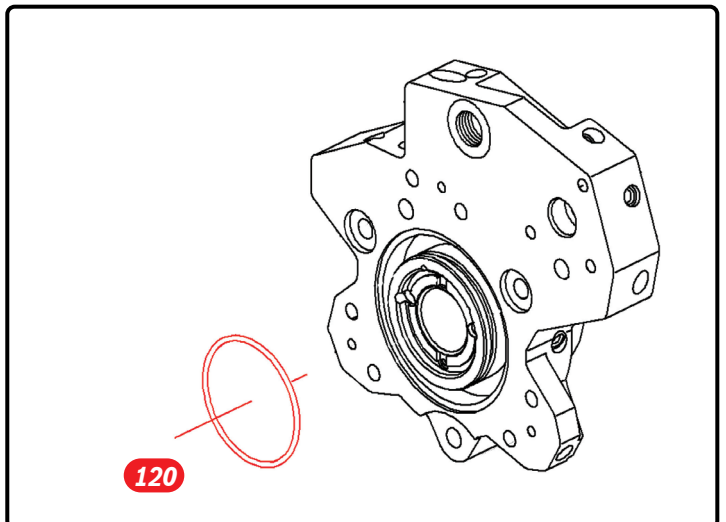
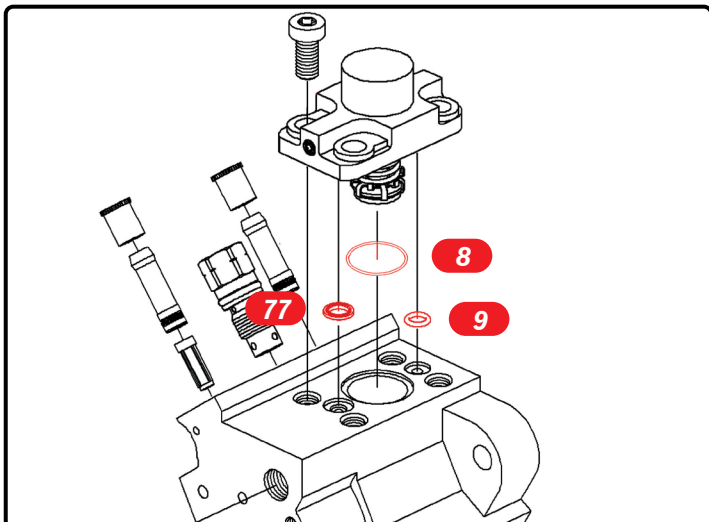
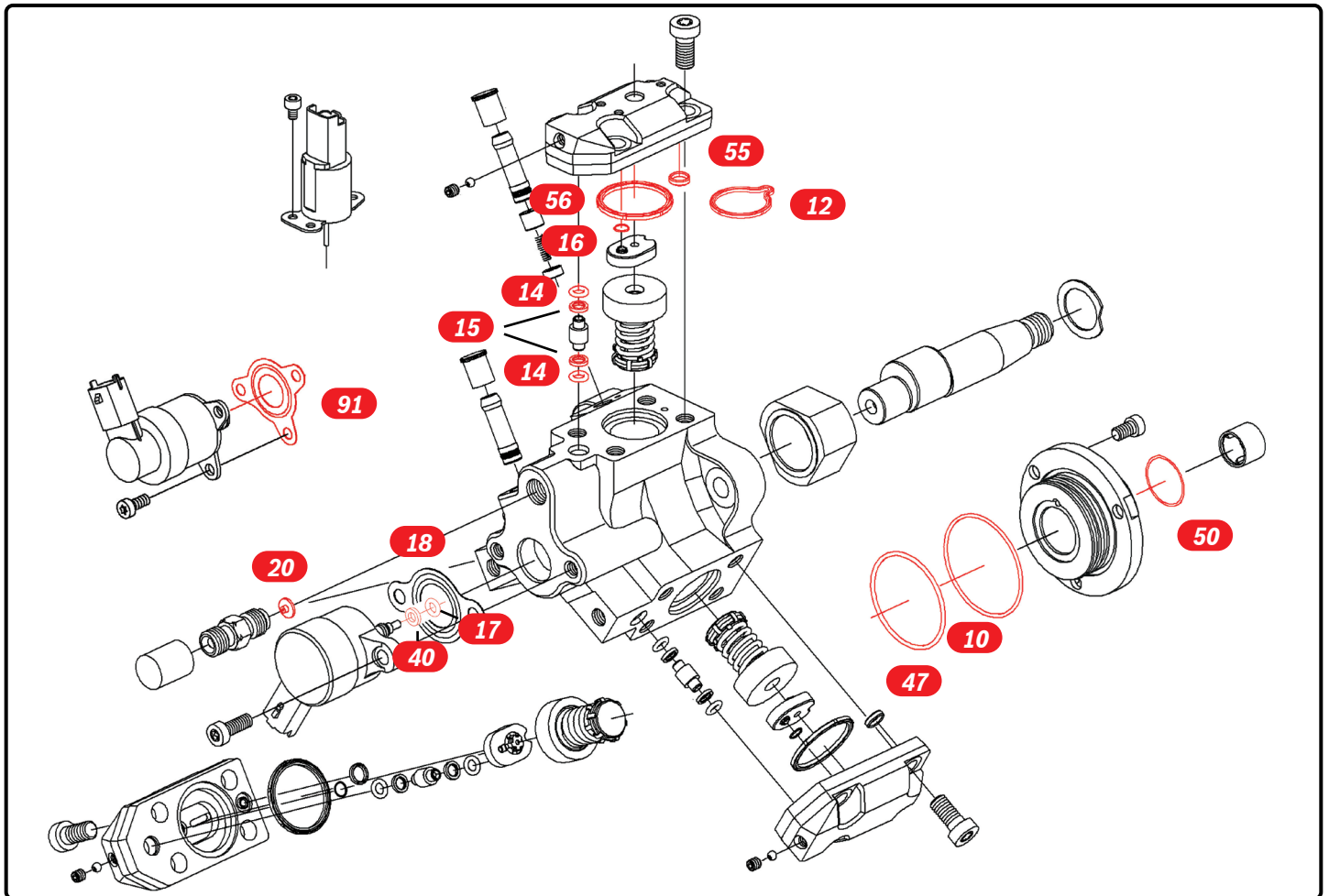

EJES DE MANDO | ARBOL EXCÉNTRICO

Código	Nº de Pieza	Nº de Bomba	Aplicación
F 00N 200 121	200	Para Bomba CP3 0 445 010 034-052	Árbol de excéntrica Cherokee 2,5 TD, Kia Sorento.
F 00N 202 712	205	Para Bba. CP3 0 445 010 228 0 445 020 046	Árbol de excéntrica bomba CP3 Iveco Daily 40 C15 - 35C15.
F 00R 0P1 112	2	0 445 010 014-014- 019-030- 032-038- 069-070-079	Árbol de excéntrica bomba radial de émbolos - Sprinter 216 / 316 / 416 DCI - Hyundai S.FE 2.0 CRDI - Kia Sportage New 2.0 CRDI.
F 00R 0P1 114	2	0 445 010 008-013- 024-027- 049-050- 253	Árbol de excéntrica bomba radial de émbolos - Sprinter 208 / 211 / 213 / 308 / 311 / 313 DCI / C200 / E200 DCI.
F 00R 0P1 128	2	0 445 010 028-020- 002	Árbol de excéntrica bomba radial de émbolos - Citroën Jumper 2.8 HDI - Fiat Ducato 10 2.8 JTD - Iveco Daily 29 L13 - Peugeot Boxer 2.8 HDI.
F 01M 100 774	2	0 445 020-056-070- 118	Árbol de excéntrica Sisu para bomba radial Cummins.
F 01M 101 212	6	No disponible	Leva de eje excéntrico Common Rail - M. Benz 208 / 211 / 213 / 308 / 311 / 313 / DCI Sprinter.

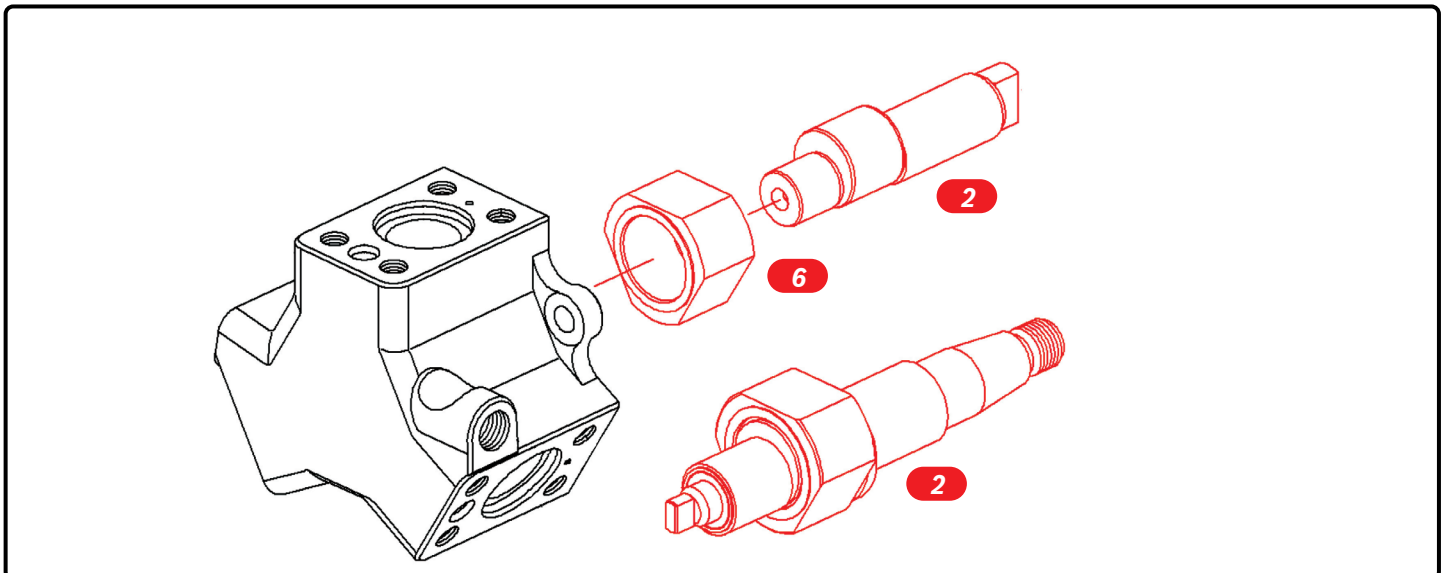
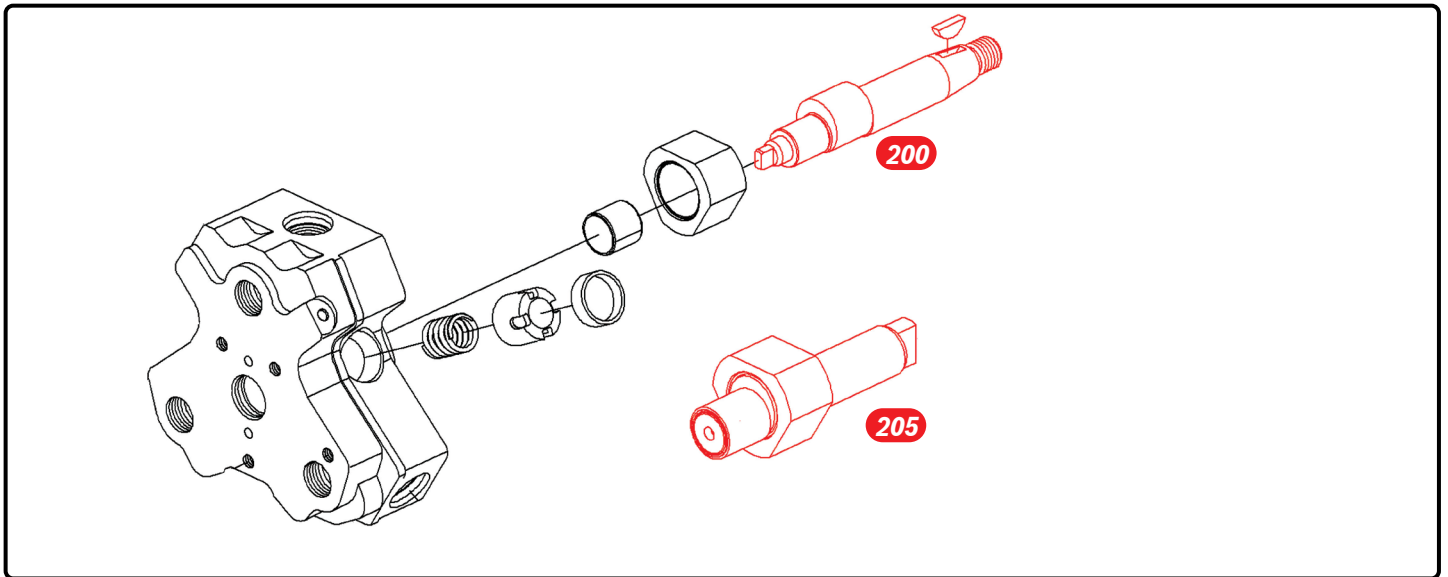

RACORD

Código	Nº de Pieza	Nº de Bomba	Aplicación
F 00N 200 495	351	0 445 010 033 0 445 042 075	Racord de empalme válvula de retención - Master 2.5 DCI c/mot G9U724. Laguna, Citroën Xsara, Peugeot 206 - 307
F 00N 200 497	351	0 445 010 034 0 445 010 084 0 445 010 104	Racord de empalme válvula de retención - Isuzu, Opel, Astra
F 00N 200 499	351	0 445 020 019 0 445 020 033 0 445 020 039	Racord de empalme válvula de retención - Ford Cargo, Deutz, Volvo, Dodge Ram
F 00N 202 311	370	0 445 010 012 0 445 033 078	Racord de empalme válvula de retención - Master 2.5 DCI c/mot G9U 724 BMW, Renault Laguna, master, MB Sprinter.
F 00N 202 320	370	0 445 020 019 0 445 020 033 0 445 020 093 0 445 020 101	Racord de empalme válvula de retención - Ford Cargo, Iveco, Deutz, Volvo
F 00R J01 572	370		Racord de presión (cánula) Inyector CR Motor Cummins 6-ISB -RAM
F 01M 100 477	27	0 445 010 010 0 445 010 229 Bomba CP1S - CP1H	Racord de empalme válvula de retención - BMW 330 - 525 d - Peugeot 206 2.0 HDI / 306 2.0 HDI.

RETENES

Código	Nº de Pieza	Nº de Bomba	Aplicación
F 01M 100 984	117	Para Bomba CP1H 0 445 010 122 0 445 010 129 0 445 010 176	Retén árbol de excéntrica Common Rail - Nissan Frontier - X Terra 2.8 D. Electronic - Master 2.5 DCI 100.
F 00R 0P0 253	130	Para Bomba CP1/CP3 0 445 010 010	Retén de eje excéntrico bomba radial de émbolos Common Rail - Renault Master 2.2 DCI90 - Citroën Xsara 1.4 HDI - Peugeot Boxer 2.0 HDI.
F 00R 0P0 521	130	Para Bomba CP3 0 445 010 012 0 445 020 007 0 445 020 175	Retén de eje excéntrico bomba radial de émbolos Common Rail - R. Master 3.0 DCI 140 - Chevrolet S10 - Blazer 2.8 D. Electronic.
F 00N 202 337	131	0 445 010 115	Retén exterior brida para bomba alta presión CP3.
F 00N 202 338	131	Para Bomba CP3 0 445 010 120 0 445 010 033	Retén de eje excéntrico, M. Benz, Renault Master.
F 00N 202 658	130	0 445 020 007	Retén eje brida bba. common rail Chevrolet S10, Blazer 2.8

BRIDAS

Código	Nº de Pieza	Nº de Inyector	Aplicación	
F 00R 0P1 726	800	0 445 010 032	Juego de reparación brida bomba Common Rail - M. Benz Sprinter. Ree. x F01M101214	
F 00R 0P1 727	800	0 445 010 037 Reparación para CP1	Juego de reparación brida bomba Common Rail - Rail Fiat - Peugeot - Renault. Brida completa con retenes, buje, arandela. Ree. x F01M101215	
F 01M 101 214	128	0 445 010 030 - 038	Brida M. Benz Sprinter - Kia Sportage	 Imagen Ilustrativa
F 01M 101 215	800	0 445 010 006 0 445 010 007 0 445 010 010 0 445 010 046	Juego de reparación brida bomba Common Rail - A. Romeo 156/166 - Fiat Marea 2.4 STD / Bravo / Punto / Stilo / Citroën Berlingo / Xsara / C5 2.0 HD / Peugeot 206 / 306	
F 00N 202 746	128	0 445 020 007	Juego de reparación brida bomba Common Rail - Inyector Tektor Ford Cargo VW con Cummins	 Imagen Ilustrativa
F 00R 0P1 209	128	0 445 010 115	Juego de reparación brida bomba Common Rail - Chevrolet S10 2.8	 Imagen Ilustrativa

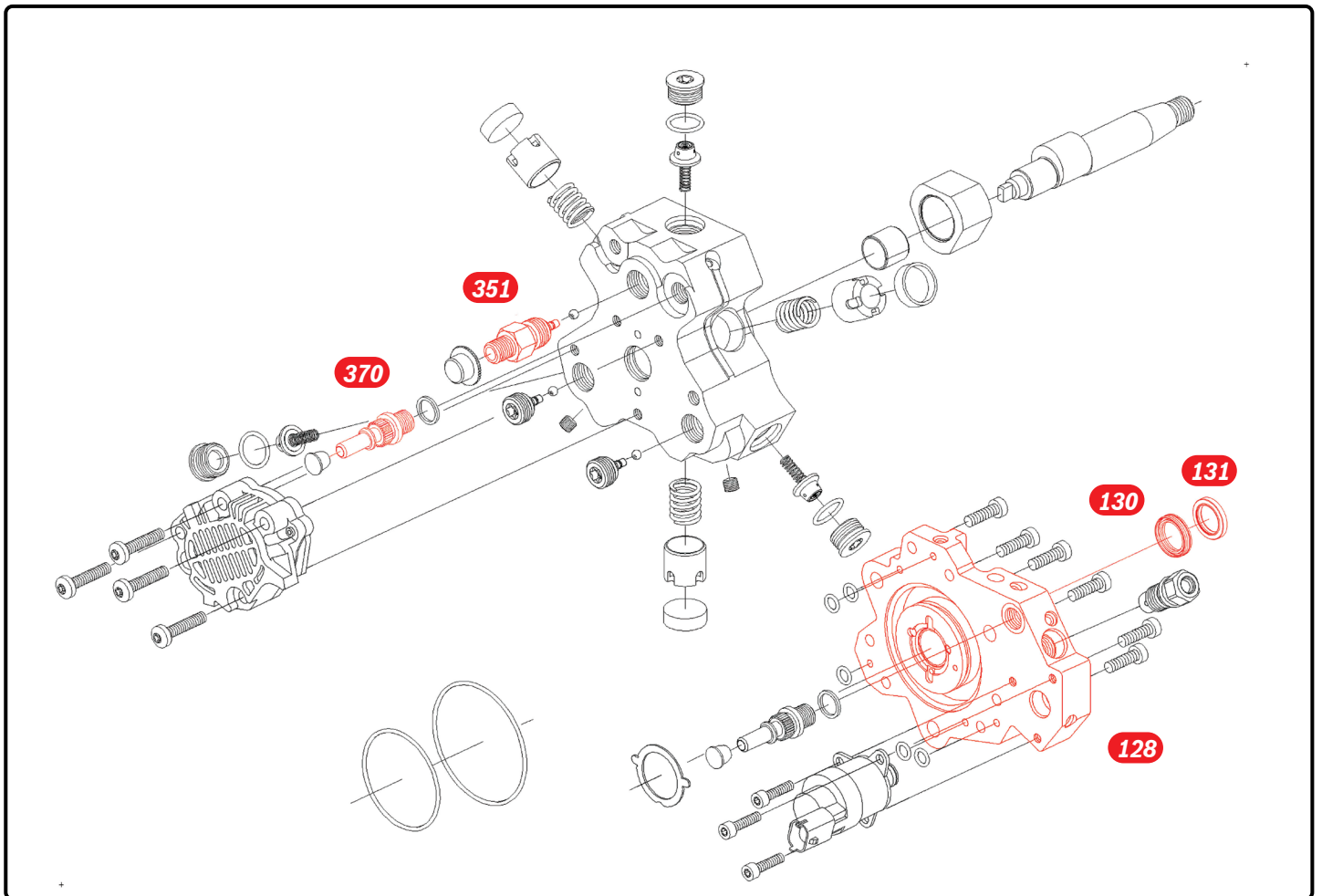
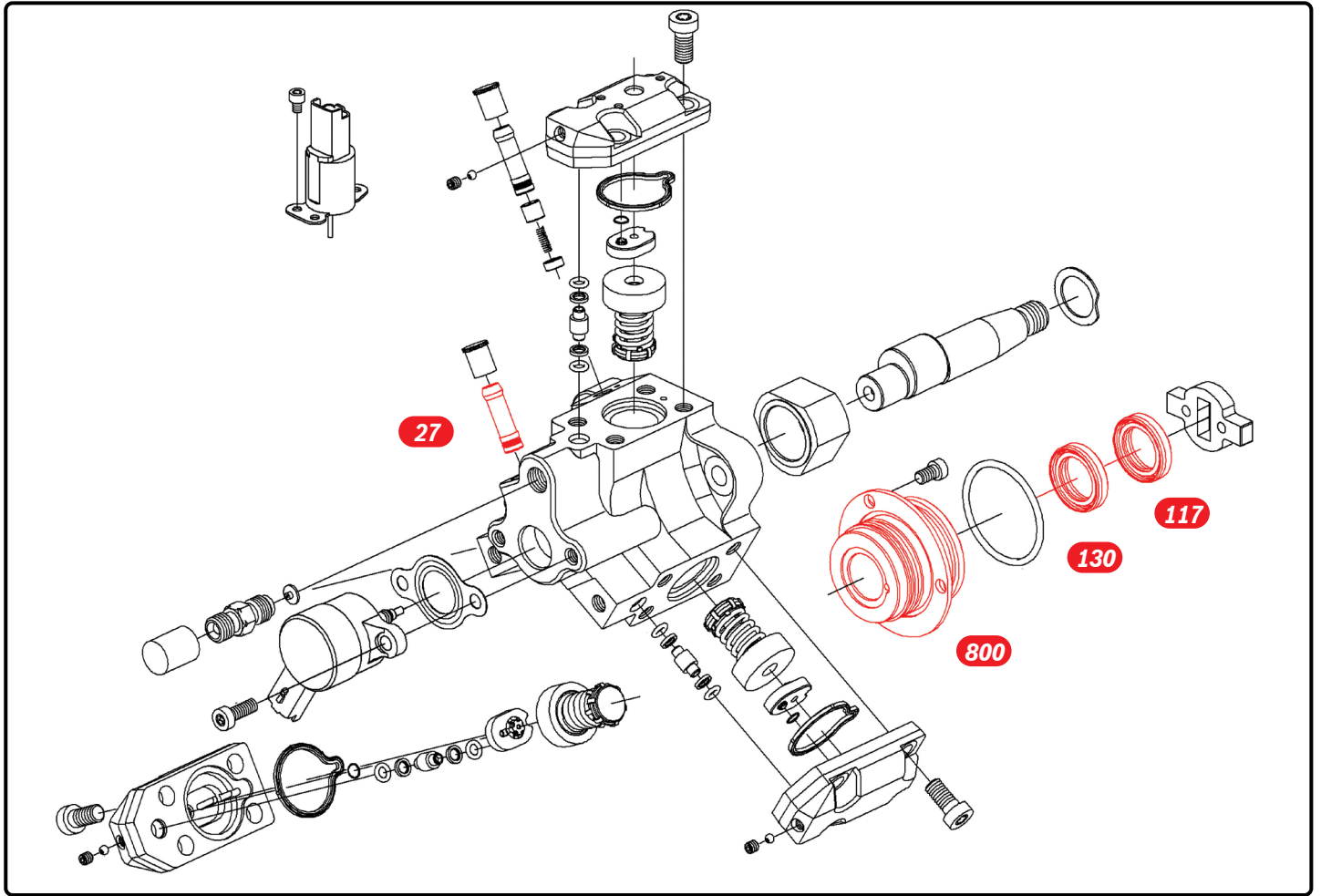

UNIDAD DOSIFICADORA (VÁLVULAS REGULADORAS DE CAUDAL)

Código	Nº de Pieza	Nº de Bomba	Aplicación	
0 928 400 473	800	No disponible	Válvula dosificadora de presión Common Rail - Cummins	
0 928 400 481	800	0 445 020 007	Válvula dosificadora de presión Common Rail - CP3S37L11 - Ford Cargo C1317E - Fiat - Iveco 170E - VW 8.150E. Electronic.	
0 928 400 487	800	0 445 010 031 0 445 010 033 0 445 010 075	Válvula dosificadora de presión Common Rail - CP3S3 - Renault Master 1.9 DCI80 - 2.2 DCI 90.	
0 928 400 498	800	0 445 010 045	Válvula dosificadora de presión Common Rail - BMW 330Cd / 525d / 530d / 318d.	
0 928 400 508	800	0 445 010 048 0 445 010 078 0 445 010 143	Válvula dosificadora de presión Common Rail - M. Benz 211 / 213 / 309 / 311 / 313 DCI Sprinter.	

Código	Nº de Pieza	Nº de Bomba	Aplicación	
0 928 400 568	800	0 445 010 034	Válvula dosificadora de presión Common Rail - Cherokee.	
0 928 400 572	800	0 445 010 133 0 445 010 154 0 445 010 178 0 445 010 328	Válvula dosificadora de presión Common Rail - Audi A4-A6 3.0 TDI	
0 928 400 607	800	0 445 010 102	Válvula dosificadora de presión Common Rail - Citroën Berlingo 1.6 HDI / C31.4 HDI - Peugeot Partner 1.6 HDI.	
0 928 400 616	800	0 445 010 043 0 445 010 057	Válvula dosificadora de presión Common Rail - Volvo S60D XC70 2.4 D.	
0 928 400 633	800	0 445 010 118 0 445 010 189	Válvula dosificadora de presión Common Rail - Hyundai, Kia.	

UNIDAD DOSIFICADORA (VÁLVULAS REGULADORAS DE CAUDAL)

Código	Nº de Pieza	Nº de Bomba	Aplicación	
0 928 400 653	800	0 445 020 030	Válvula dosificadora de presión Common Rail - General Motors	
0 928 400 654	800	0 445 010 039 0 445 010 076 0 445 010 086	Válvula dosificadora de presión Common Rail - BMW - Isuzu.	
0 928 400 656	800	0 445 010 123 0 445 010 166 0 445 010 173 0 445 010 222 0 445 010 252	Válvula dosificadora de presión Common Rail - A. Romeo 159 2.4 JTDM.	
0 928 400 660	800	0 445 020 008	Válvula dosificadora de presión Common Rail - Fiat Ducato 11 2.3 JTD - Iveco Daily 29L10.	
0 928 400 666	800	0 445 020 039	Válvula dosificadora de presión Common Rail - Cosechadora Case, Dodge RAM 2500.	

Código	Nº de Pieza	Nº de Bomba	Aplicación	
0 928 400 676	800	0 445 010 090 0 445 010 125	Válvula dosificadora de presión Common Rail - Audi A4 2.7TDI / A4 3.0TDI.	
0 928 400 678	800	0 445 010 149 0 445 010 190	Válvula dosificadora de presión Common Rail - Hyundai IX55 30 V6 CRDI.	
0 928 400 680	800	0 445 010 150- 155- 156-157-183-184- 185-193-202-204- 241-242-243-249	Válvula dosificadora de presión Common Rail - Fiat Punto 1.3 MJTD.	
0 928 400 681	800	0 445 010 081 0 445 010 089 0 445 010 094	Válvula dosificadora de presión Common Rail - Citroën Xsara Picasso1.6 HDI - Ford Focus 1.6 TDCI.	
0 928 400 697	800	0 445 020 123 0 445 020 149	Válvula dosificadora de presión Common Rail - Motoniveladora Komatsu. Ford Cargo F250 Motor Cummins, VW, Constellation, Worker.	

UNIDAD DOSIFICADORA (VÁLVULAS REGULADORAS DE CAUDAL)

Código	Nº de Pieza	Nº de Bomba	Aplicación	
0 928 400 706	800	0 445 010 507	Válvula dosificadora de presión Common Rail - VW Amarak 2.0, Audi, Seat con bomba CP4 Camara. Reemplazado x 1462C00987	
0 928 400 712	800	0 445 020 043 0 445 020 045 0 445 020 122 0 445 020 150	Válvula dosificadora de presión Common Rail - Dongfeng 67 lts.	
0 928 400 713	800	0 445 010 101 0 445 010 052	Válvula dosificadora de presión Common Rail - Kia Sorento 2.5 CRDI - Hyundai H1 2.5 CRDI.	
0 928 400 714	800	0 445 010 087	Válvula dosificadora de presión Common Rail - Renault Laguna II 109 DCI / Megane II 1.9 DCI / Scenic II 1.9 DCI.	
0 928 400 717	800	0 445 010 119	Válvula dosificadora de presión Common Rail - Audi Q7 4.2 TDI.	

Código	Nº de Pieza	Nº de Bomba	Aplicación
0 928 400 718	800		Válvula reguladora de caudal motor Volvo Marino.
0 928 400 719	800	0 445 010 135	Válvula dosificadora de presión Common Rail - M. Benz C320 DCI 4 Matic - CLS320 DCI Coupe.
0 928 400 724	800	0 445 020 056	Válvula dosificadora de presión Common Rail - Nissan - Renault Master 2.2 DCI.
0 928 400 728	800	0 445 010 181 0 445 010 318 0 445 010 179	Válvula dosificadora de presión Common Rail - Iveco Daily, Ducato 2,3 JTD
0 928 400 736	800	0 445 010 115	Válvula dosificadora de presión Common Rail - Chevrolet S10 2.8 D. Electronic - Blazer 2.8D. Electronic. Reemplazo 0928400614.

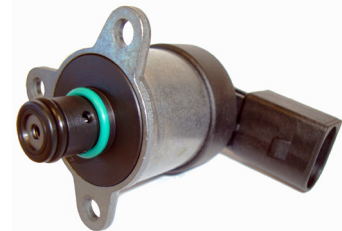
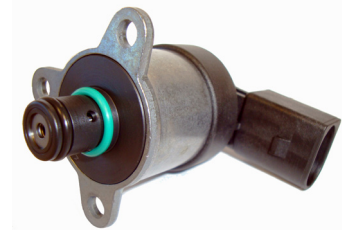

UNIDAD DOSIFICADORA (VÁLVULAS REGULADORAS DE CAUDAL)

Código	Nº de Pieza	Nº de Bomba	Aplicación
0 928 400 739	800	0 445 020 046	Válvula dosificadora de presión Common Rail - Iveco Daily 35 C15 / C18 / S14 / Fiat Ducato 3.0 JTD.
0 928 400 789	800	0 445 020 033	Válvula dosificadora de presión Common Rail - VW 15.180 / 15190 / 17210 / 17230 / 17260 EOD Electronic.
1 462 C00 987	800	0 445 010 507	Válvula dosificadora de presión Common Rail - VW Amarok con bomba CP4. Cámara.

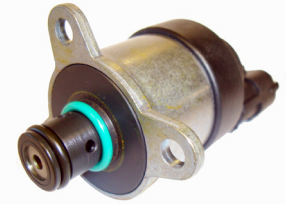

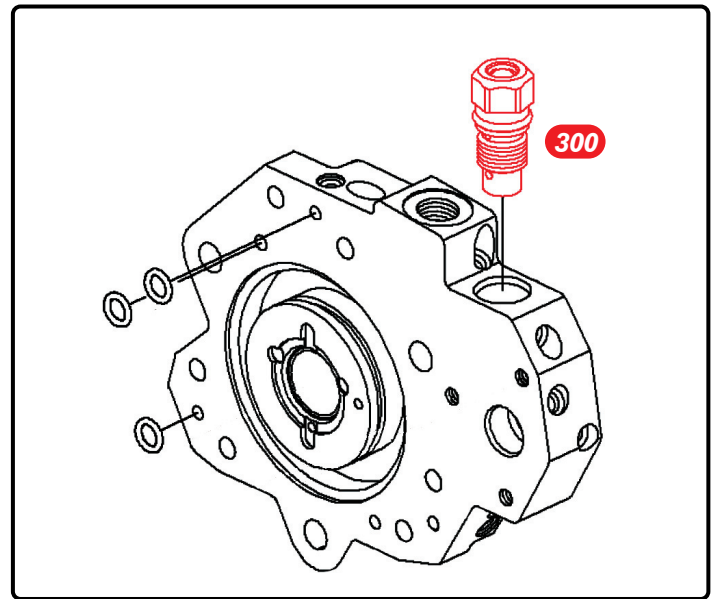
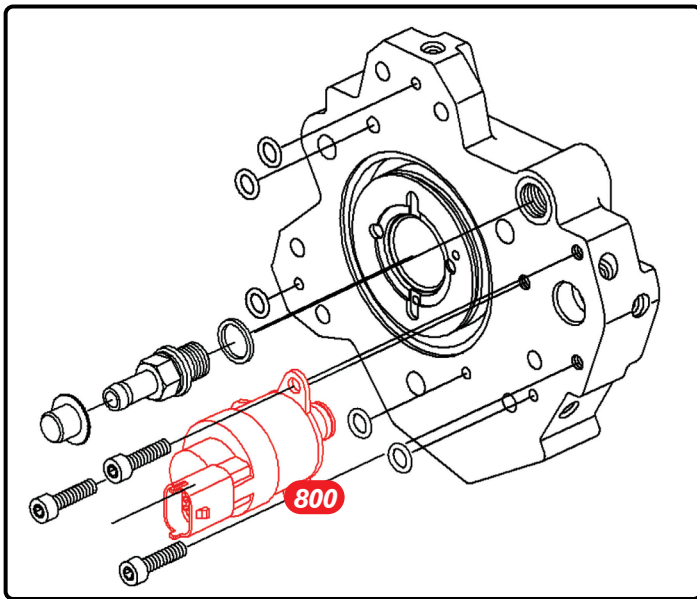
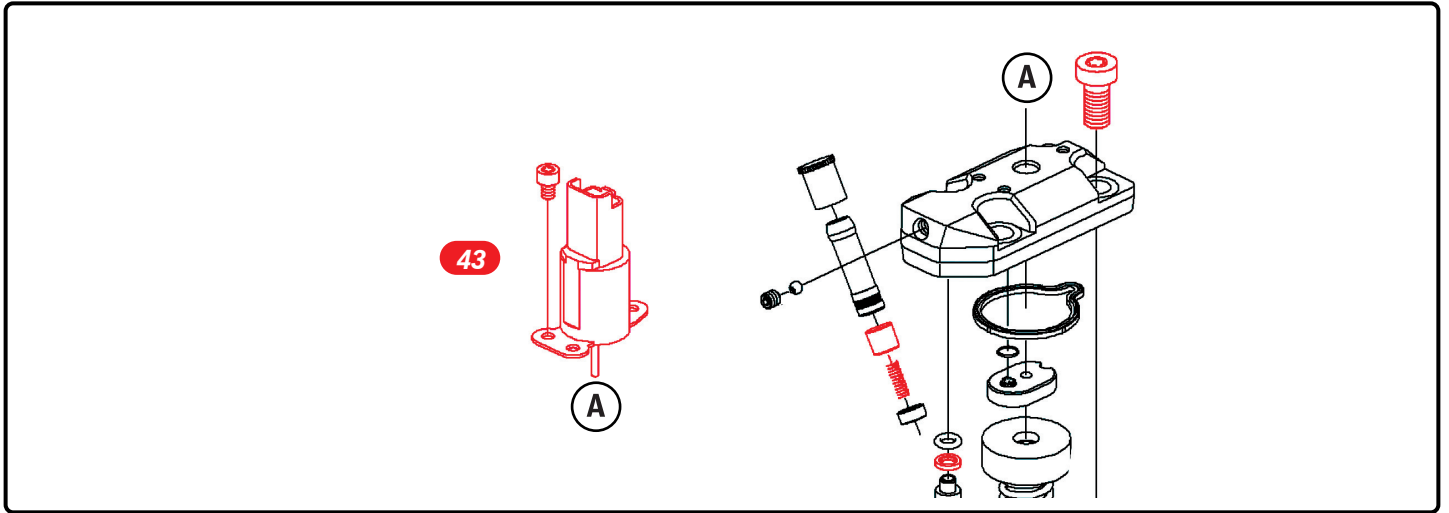

VÁLVULAS DE DESCARGA

Código	Nº de Pieza	Nº de Bomba	Aplicación	
0 928 400 323	43	0 445 010 024 0 445 010 025 0 445 010 030	Válvula de descarga bomba radial CP1K3 / L60 / 10 / 65 - M. Benz 208 / 211 / 213 / 308 / 311 / 313 DCI Sprinter.	
0 928 400 365	43	0 445 020 002 0 445 020 006	Válvula de descarga bomba radial CP1 S3 - Citroën Jumper 2.8 HDI - Fiat Ducato 10 2.8 JTD - Iveco Daily 29 L13 / 35C11.	
0 928 400 366	43	0 445 010 010 0 445 010 021 0 445 010 046 0 445 010 162 0 445 010 163	Válvula de descarga bomba radial CP1 S3 - Citroën Berlingo 2.0 HDI / C5 2.0 HDI - Peugeot 206 2.0 HDI / 306 / 307.	
0 928 400 384	43	0 445 010 013 0 445 010 032	Válvula de descarga bomba radial CP1K3 - M. Benz 108 / 110 / 112 DCI Vito.	
F 00N 200 798	300	0 445 010 033 0 445 010 042 0 445 020 123	Válvula de descarga bomba radial CP1H3 / C. Renault Laguna - Masler - Traffic 2,5 - Citroën Xsara - Peugeot 206, 307 - Ford Cargo con Cummins.	
F 00R 0P0 776	300	0 445 010 005 0 445 010 012 0 445 010 033	Válvula de descarga bomba radial Case New Holland - BMW - Renault - Laguna - Master. Reemplazado x F 00N 200 798	
F 01M 101 223 Ree. x F 01M 100 749	300	0 445 010 123-129- 137-142- 150-155- 156-157 -166-173- 180- 181-183	Válvula de descarga bomba radial N. Fontier - Xterra 2.8 D. Electronic.	

Imagen Ilustrativa

VARIOS | ARANDELAS

Código	Nº de Pieza	Nº de Bomba	Medida	Aplicación
F 00N 000 066	17	0 445 010 010	-	Arandela de teflón de apoyo para válvula reguladora de presión Common Rail varias.
F 00R 0P0 004	20	0 445 010 010	-	Arandela plana de Racord de Bomba CP1
F 00R 0P0 044	15	0 445 010 010	-	Arandela plástica pieza unión bomba radial de émbolo Common Rail - Citroën - BMW - Peugeot - Renault - Fiat.
F 00N 200 201	212	0 445 010 033	2,10 mm.	Arandela de tope Calibrada - Bomba alta presión CP3. De brida de bomba Renault Master.
F 00N 200 202	212	0 445 010 033	215,mm	Arandela de tope - Bomba alta presión CP3. De brida de bomba Renault Master.
F 00N 200 203	212	0 445 010 033	2,20 mm.	Arandela de tope - Bomba alta presión CP3. De brida de bomba Renault Master.
F 00N 200 772	212	0 445 010 126	2,00 mm.	Arandela de tope calibrado para bomba alta presión CR CP3S3. BMW X3 / X5 / 318 / 320 / 520 / 530
F 00N 200 773	212	0 445 010 126	2,05 mm.	Arandela de tope calibrado para bomba alta presión CR CP3S3. BMW X3 / X5 / 318 / 320 / 520 / 530
F 00N 200 774	212	0 445 010 126	2,10 mm.	Arandela de tope calibrado para bomba de alta presión CR CP3S3. BMW X3 / X5 / 318 / 320 / 520 / 530
F 00N 200 775	212	0 445 010 126	2,15 mm.	Arandela de tope calibrado para bomba de alta presión CR CP3S3. BMW X3 / X5 / 318 / 320 / 520 / 530
F 00N 200 776	212	0 445 010 126	2,20 mm.	Arandela de tope calibrado para bomba de alta presión CR CP3S3. BMW X3 / X5 / 318 / 320 / 520 / 530
F 00N 201 046	212	0 445 010 074	1,60 mm.	Arandela de tope calibrado para bomba de alta presión CR 04450100. BMW 740 / 745.
F 00N 201 047	212	0 445 010 074	1,65 mm.	Arandela de tope calibrado para bomba de alte presión CR 04450100. BMW 740 / 745.
F 00N 201 048	212	0 445 010 074	0,70 mm.	Arandela de tope calibrado para bomba de alte presión CR 04450100. BMW 740 / 745.
F 00R 0P0 681	212	0 445 010 094	1,10 mm.	Arandela de tope de brida bomba radial CP3 - Renault Master 3.0DCI140. VW Constellation.
F 00R 0P0 682	212	0 445 010 094	1,15 mm.	Arandela de tope de brida bomba radial de émbolos CP3 - Renault Master 3,0DCI140. VW Constellation.
F 00R 0P0 683	212	0 445 010 094	1,20 mm.	Arandela de tope de brida bomba radial de émbolos CP3 - Renault Master 3,0DCI140. VW Constellation.
F 00R 0P0 689	213	0 445 020 072	-	Arandela de tope árbol de excéntrica bomba radial de émbolo - Renault Master 3.0DCI 140. Dodge Ram.
F 00R 0P0 690	214	0 445 020 072	-	Arandela de tope árbol de excéntrica bomba radial de émbolo - Renault Master 3.0DCI 140. Dodge Ram.

VARIOS

Código	Nº de Pieza	Nº de Bomba	Aplicación
F 00R 0P0 133	31	0 445 020 008	Soporte acoplamiento M. Benz Sprinter
F 00R 0P0 182	24	0 445 010 010	Embolo racord empalme bba. CP3 Peugeot, Citroën 2.0
F 00R 0P0 183	26	0 445 010 010	Resorte para émbolo racord Peugeot, Citroën 2.0
F 00R 0P1 718	28	0 445 010 006	Tornillo cabeza cilíndrica de brida bomba radial - Fiat - A. Romeo - M.Sprinter - Citroën - Peugeot. 206, 306, Partner.
F 01M 100 684	18	0 445 010 006	Tornillo cilíndrico Torx de tapa de émbolo Common Rail - Citroën - Peugeot 206 / 306 / Partner - M. Benz - Nissan F. - A. Romeo.
F 01M 101 785	81	0 445 010 129	Filtro plástico racord, bomba, émbolos.
F 00N 200 657	16	0 445 010 047	Tapón roscado para cuerpo de bomba CP3, M. Benz, Cummins

Código	Nº de Pieza	Nº de Bomba	Aplicación
F 00V C22 003	373	0 445 010 105	Seguro de válvula de bomba CP3 Toyota Corolla.



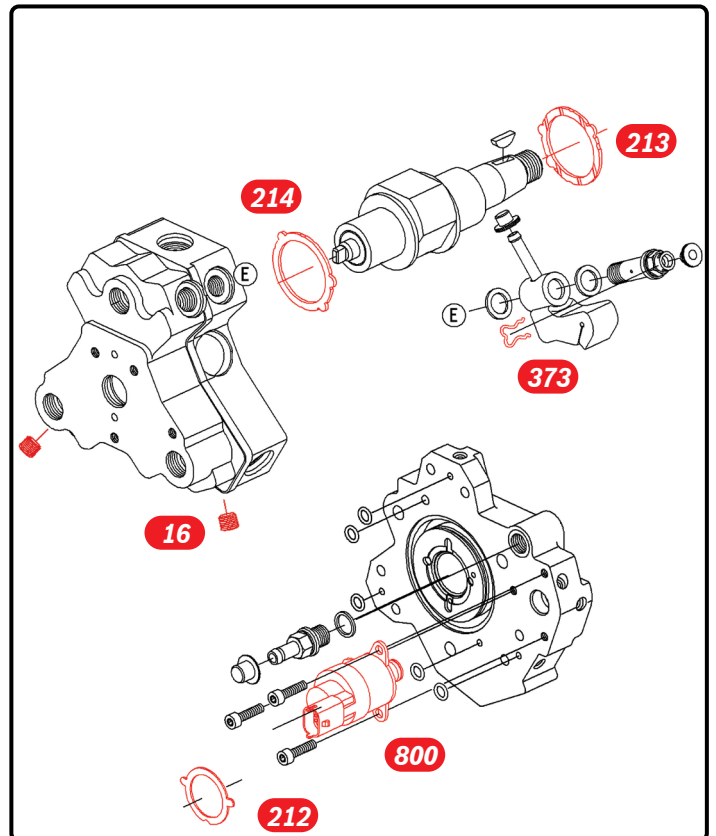
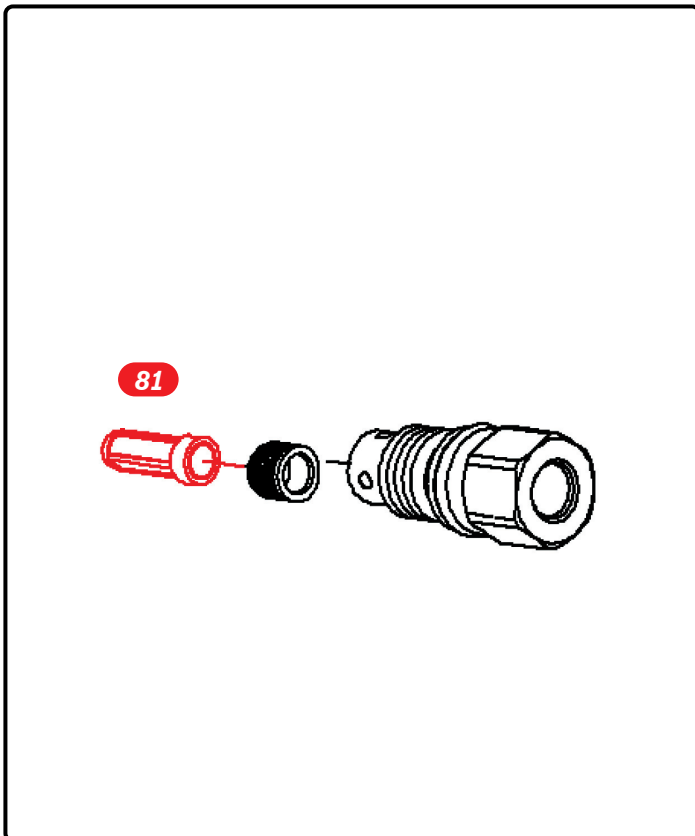
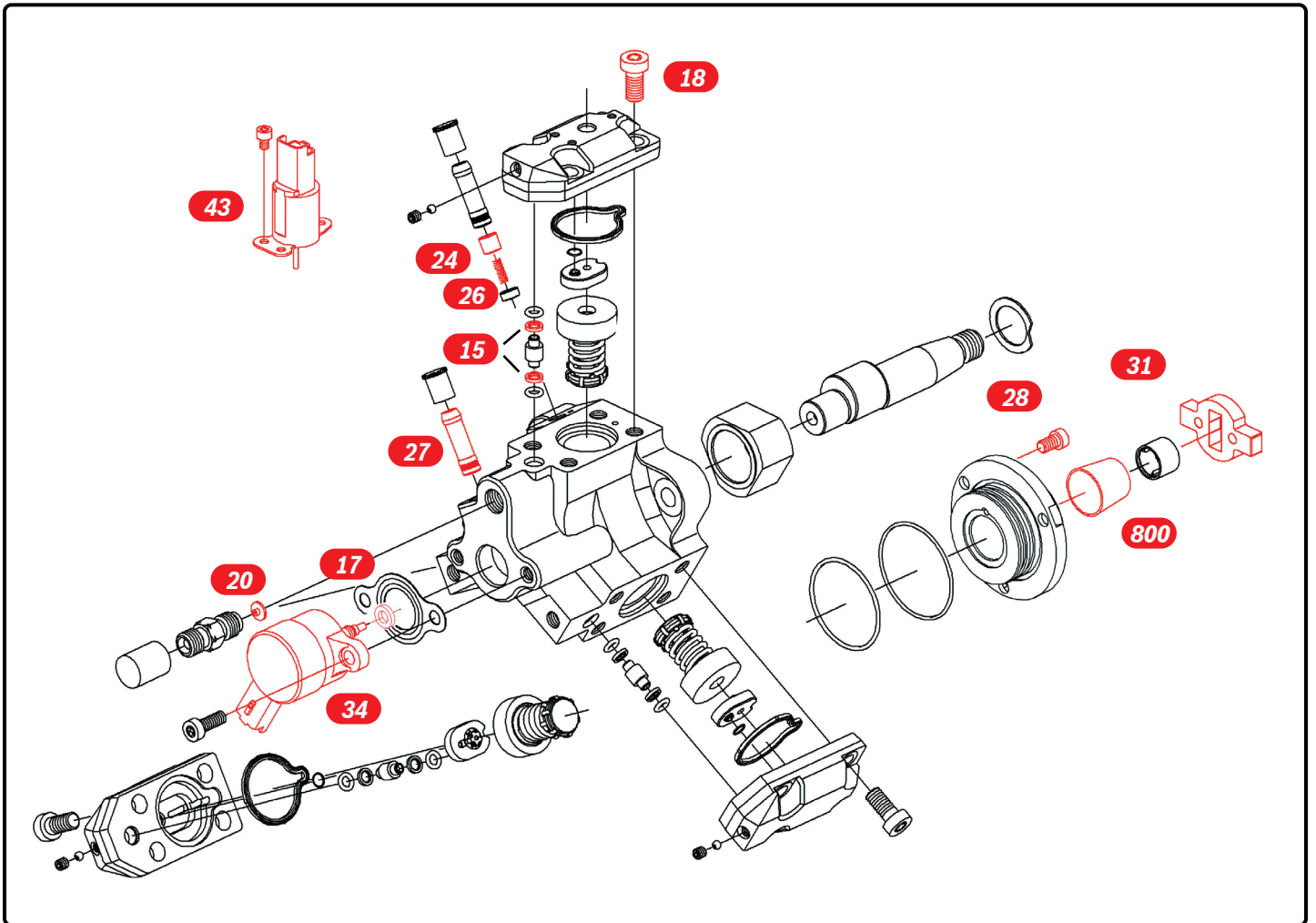

VÁLVULAS REGULADORAS DE PRESIÓN (BOMBA)

Código		Aplicación		
0 281 002 483	34	0 445 010 018 0 445 010 028	Válvula reguladora de presión bomba radial de émbolo - Renault Kangoo I 1.9 DCI - Scenic 1.9 DCI.	
0 281 002 488	34	0 445 010 006 0 445 010 007 0 445 010 071 0 445 010 072	Válvula reguladora de presión bomba radial de émbolo - Fiat Brava 1.9 JTD - Palio Weekend 1.9 JTD.	
0 281 002 500	34	0 445 020 002 0 445 020 006 0 445 020 040	Válvula reguladora de presión bomba radial de émbolo - Fiat Ducato 2.8 - Iveco Daily 35.13 / 40.13 / 50.13.	
0 281 002 872	34	0 445 010 162 0 445 010 163 0 445 010 164 0 445 010 010 0 445 010 121 0 445 010 042 0 445 010 132	Válvula reguladora de presión bomba radial de émbolo - Kia Sorento 2.5 CRDI. Citroën Berlingo, Xsara, Peugeot 206 / 306 / 307 / Expert / Partner / Chevrolet / Suzuki / Vitara / Fiat Ducato. Reemplaza a 0 281 002 493	

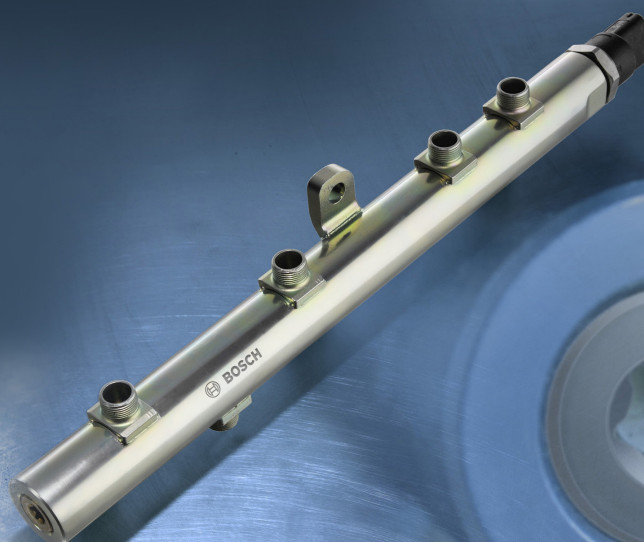

RAIL - RAMPA DISTRIBUIDORA

RAMPAS COMPLETAS

Código		Aplicación
0 445 214 063	Válvula (0281002698) Sensor (0281002700)	Rampa Common Rail M. Benz. Sprinter 208 / 311 / 213 / 308 / 311 / 313 DCI / C 200 DCI.
0 445 214 082	Válvula (1110010017) Sensor (0281002907)	Rampa Common Rail V4 / 10-235I - Chevrolet Blazer - S10 - Nissan Frontier 2.8 Diesel Electronic.
0 445 214 086	Válvula (0281002507) Sensor (0281006158)	Rampa Common Rail V4 / 10-125 - Fiat Punto 1.3 MJTD 16V.
0 445 214 142	Válvula (1110010017) Sensor (0281002734)	Rampa Common Rail V4 / 10-235 - A. Romeo 147 1.9 JTD / 156 JTD.
0 445 215 020	Válvula (0281002698) Sensor (0281002700)	Rampa Common Rail V5 / 10-125 - M. Benz 216 DCI / 316 / 416 Sprinter.

Código	Aplicación	
0 445 224 012	Válvula (1110010035) Sensor (0281006325)	Rampa Common Rail V4 / 10-235 - Ford Cargo C1317E / C1517E / C1717E / Ford 250. VW Camión 9.150 E Interact 4.0 Euro 3 - VW Camión 9.150E Interac CT 4.0 Euro 3.
0 445 226 007	Válvula (1110010033) Sensor (0281002405)	Rampa Common Rail V6 / 10-2345 - 270 Premium D.
0 445 226 020	Válvula (1110010035) Sensor (0281002325)	Rampa Common Rail V6 / 10-235 - Ford Cargo C1722 / 2422 / 2428 / 2622 E.
0 445 226 025	Válvula (1110010020) Sensor (0281002018)	Rampa Common Rail V6 / 10-235 - Ford Cargo C2632 / 2932 E. VW Cummins Omnibus 18.320 EOT.
0 445 226 042	Válvula (1110010015) Sensor (0281002325)	Rampa Common Rail V6 / 710-235 - Dongfeng.
0 445 226 046	Válvula (1110010041) Sensor (0281002907)	Rampa Common Rail V6 / 10-235 - Volvo VM310 MWM.

DESPIECE DE RAMPA | SENSORES DE PRESIÓN

Código	Nº de Pieza	Nº de Rampa	Aplicación	
0 281 002 497	11	0 445 214 030-071- 008-015-016-023	Sensor de presión rampa Common Rail - BMW 118D / 318D / 320CD - Land Roverd (N. de rampa 0445214063 / 215020).	
0 281 002 498	11	0 445 213 002 - 0 445 214 007 - 008 - 033 0 445 215 006 0 445 216 003	Sensor de presión rampa Common Rail - M. Benz. Sprinter 211 / 213 / 216 / 311 / 313 DCI.	
0 281 002 522	11	0 445 214 015 - 018 - 024 - 025 - 077 - 146	Sensor de presión rampa Common Rail - Renault Kangoo I 1.9 DCI - Laguna II 1.9 DCI - Megane 1.9 DCI - Scenic 1.9 DCI.	
0 281 002 534	11	0 445 214 040-050- 051- 054-055-059- 0 445 076 121 - 0 445 215 013 - 0 445 224 015 - 016	Sensor de presión rampa Common Rail - Ford Cargo 1830 / 2524 - Fiat Punto 1.3 MJTD - Renault Master 3.0 DCI140.	
0 281 002 568	11	0 445 214 042- 0 445 226 004-022- 024-028	Sensor de presión rampa Common Rail - VW Brasil Bus 17.260 EOT MW 6.12 TCAE Euro 3.	

Código	Nº de Pieza	Nº de Rampa	Aplicación
0 281 002 700	11	0 445 214 063 - 215 020	Sensor de presión rampa Common Rail - M. Benz Sprinter 311 / 313 / 316. Reemplazado x 0 281 002 942
0 281 002 706	11	0 445 214 068 - 069 - 089	Sensor de presión rampa Common Rail - Fiat Stilo 1.9JTD 16V - A. Romeo 156 1.9JTD.
0 281 002 788	11	0 445 214 035 - 036 - 0 445 216 002 - 0 445 224 009	Sensor de presión rampa Common Rail - Citroën Jumper 2.8 HDI - Fiat Ducato 2.8JTD - Peugeot Boxer 2.8 HDI. Reemplazado x 0 281 002 909
0 281 002 797	11	0 445 214 010 - 091	Sensor de presión rampa Common Rail - Audi A4 2.0 / 3.0 TDI / Q7 3.0 TDI - Seat León 1.9 / 2.0 TDI. Citroën Xantia, Xara, Peugeot 206/306/406, Suzuki, Grand Vitara. Reemplazado x 0 281 002 592
0 281 002 801	11	0 445 214 104-114- 179	Sensor de presión rampa Common Rail - Renault Master 2.5 DCI 100. Megane II, Scenic II.



DESPIECE DE RAMPA | SENSORES DE PRESIÓN

Código	Nº de Pieza	Nº de Rampa	Aplicación	
0 281 002 851	11	0 445 224 012-013-025-226-014-020-025-042-045-092	Sensor de presión rampa Common Rail - Ford Cargo C2632E / 2932E - VW 18.320 EOT.	
0 281 002 863	11	0 445 213 017 - 214 180 - 181 - 197 - 198	Sensor de presión rampa Common Rail - Hyundai H1 2.5 CRDI Cargo.	
0 281 002 903	11	0 445 214 122 - 214	Sensor de presión rampa Common Rail. 0445214086/117/ Chevrolet Astra 2,0, Zafira 1,9, Corsa 1.3. Reemplazado x 0 281 002 472	
0 281 002 907	11	0 445 214 082 - 0 445 224 019 - 026 - 028 - 0 445 226 031 - 046	Sensor de presión rampa Common Rail - Chevrolet S10 - Nissan Frontier.	
0 281 002 908	11	0 445 214 061 - 066 - 067 - 101	Sensor de presión rampa Common Rail. Kia Sorento 2,5 CRDI	

Código	Nº de Pieza	Nº de Rampa	Aplicación
0 281 002 909	11	0 445 214 074 0 445 013 006	Sensor de presión rampa Common Rail - Kia Sportage, Carens, Hyundai, Accent.
0 281 002 964	11	0 445 214 041 - 227 - 0 445 224 020	Sensor de presión rampa Common Rail - Eurocargo, Opel, Astra. Reemplaza a 0 281 002 398
0 281 002 930	11	0 445 214 240 -254-224- 0 445 024 049 - 051 - 058 - 064 - 065	Sensor de presión rampa Common Rail - Iveco Eurocargo 90 E 18 / Cosechadora New Holland con motor Iveco.
0 281 002 937	11	0 445 212 005-006 0 445 213 018 - 0 445 214 045 - 119 - 126 - 128 - 159 - 168 - 169 - 172	Sensor de presión rampa Common Rail - EuroCargo 100 E17 / 130 E 18. Reemplaza a 0 281 002 700
0 281 006 032	11		Sensor de Presión Common Rail Iveco Daily 55 C17B Modelo Nuevo



Código	Nº de Pieza	Nº de Rampa	Aplicación
0 281 006 053	11	0 445 214 270 - 0 445 224 029 - 030 - 0 445 226 047 - 048	Sensor de presión rampa Common Rail - Midlum II / Premium II / Volvo / Deutz
0 281 006 507	11	0 445 214 010 - 091	Sensor de alta presión. Peugeot / Citroën 2.0 Hdi , Suzuki Vitara 2.0 Tdi. Reemplaza a 0281002797.



VÁLVULAS REGULADORAS DE PRESIÓN (RAMPA)

Código	Nº de Pieza	Nº de Rampa	Aplicación	
0 281 002 241	10	0 445 213 002- 003 - 0445 214 007 - 008 - 033 - 0 445 216 003	Válvula reguladora de presión rampa Common Rail - M. Benz Sprinter 208 / 211 / 213 / 308 / 311 / 313 DCI.	
0 281 002 445	10	0 445 213 004 - 005 0 445 214 026 - 039	Válvula reguladora de presión rampa Common Rail - Hyundai Santa Fe 2.0 CRDI - Kia Carens 2.0.	
0 281 002 494	10	0 445 213 012- 014- 0 445 214 037-072 -096-148-150 -162 -164 0 445 215 011 0 445 216 006	Válvula reguladora de presión rampa Common Rail - M. Benz E270 / C22DCI / ML 320 DCI.	
0 281 002 507	10	0 445 214 056 - 102 - 110	Válvula reguladora de presión rampa Common Rail - Fiat Doblo - Cargo - A. Romeo - Opel - Astra - Vectra.	
0 281 002 682	10	0 445 214 166 0 445 215 016	Válvula reguladora de presión rampa Common Rail - M. Benz Sprinter 215, 315, L115, 515, 816, 416.	

Código	Nº de Pieza	Nº de Rampa	Aplicación
0 281 002 698	10	0 445 214 063 0 445 215 020	Válvula reguladora de presión rampa Common Rail - M. Benz 211 / 213 / 308 / 311 / 313 / 316 DCI Sprinter.
0 281 002 738	10	0 445 214 134 -182 -216 015	Válvula reguladora de presión rampa Common Rail - BMW X5 3.0D. BMW 118 / 116 / 316 / 318 / 320. BMW 330 / 530.
0 281 002 854	10	F 00R 001 823 - 859	Válvula reguladora de presión rampa Common Rail - VW. Touareg, Audi A8, A6, A4.
0 281 006 032	10	0 281 006 032	Válvula reguladora de presión. Iveco Daily Nuevo 55 C 17 /70 C 17 3.0 17 3.0
0 281 006 074	10	No Disponible	Válvula reguladora de presión rampa Common Rail - VW Amarok 2,0 TDI.



VÁLVULAS LIMITADORAS DE PRESIÓN

Código	Nº de Pieza	Nº de Rampa	Aplicación	
1 110 010 007	12	0 445 226 016 - 017	Válvula limitadora de presión rampa Common Rail - VW Constellation.	
1 110 010 014	12	0 445 224 037	Válvula limitadora de presión rampa Common Rail - Ford Case - New Holland - Komatsu.	
1 110 010 017	12	0 445 214 082- 115- 142	Válvula limitadora de presión rampa Common Rail - Chevrolet S10 2.8 Electrónica.	
1 110 010 019	12	0 445 214 113 - 116 - 145 - 227	Válvula limitadora de presión rampa Common Rail - Renault Master 2.5DCI - Meriva 1 - Me- gane Scenic 1.9DCI - Chevrolet Astra.	
0 110 010 020	12	0 445 226 025 0 445 226 034	Válvula limitadora de presión rampa Common Rail - Ford Cargo, VW Constellation motor Cummins, Camiones man.	

Código	Nº de Pieza	Nº de Rampa	Aplicación	
1 110 010 022	12	0 445 224 017 - 024 - 026 - 027 - 032 - 036-037 - 040	Válvula limitadora de presión rampa Common Rail - Iveco Eurocargo 90 E18 / 120 / 160 / Cosechadora New Holland con motor Iveco serie W.	
1 110 010 027	12	0 445 224 028 - 0 445 226 043 - 0 445 227 001	Válvula limitadora de presión rampa Common Rail - Volvo M310.	
1 110 010 035	12	0 445 224 010 - 014 - 019 - 0 445 226 012 - 018 - 020 - 031	Válvula limitadora de presión rampa Common Rail - VW- Ford EuroCargo 100 E17.	
F 00R 000 632	12	No disponible	Válvula limitadora de presión rampa Common Rail - Dodge Ram.	
F 00R 000 644 Ree. x 1 110 010 030	12	0 445 214 024 - 029 - 035 - 036 - 077 - 226019 - 024 - 028.	Válvula limitadora de presión rampa Common Rail - Renault Laguna II 1,9 DCI - Master 1.9 DCI80 - Megane II 1.9 DCI.	

VÁLVULAS LIMITADORAS DE PRESIÓN

Código	Nº de Pieza	Nº de Rampa	Aplicación	
F 00R 000 741	12	0 445 214 042 - 065 - 079	Válvula limitadora de presión rampa Common Rail - Kia So- rento 2.5CRDI - Renault Master 2.5 DCI100.	
F 00R 000 756	12	No disponible	Válvula limitadora de presión rampa Common Rail - Premium 270. Renault - Iveco.	
F 00R 000 761	12	No disponible	Válvula limitadora de presión rampa Common Rail - Iveco Euro Cargo 170E22.	
F 00R 000 775	12	0 445 224 004 - 046	Válvula limitadora de presión rampa Common Rail - VW 13170 E / 15170E - Ford C1317E / 1517E / F250.	
F 00R 001 166	12	0 445 214 043 - 051 - 078 - 080 - 093	Válvula limitadora de presión rampa Common Rail - Renault Master 3.0 DCI 140 - Laguna II 1.9DCI - Scenic II 1.9 DCI.	

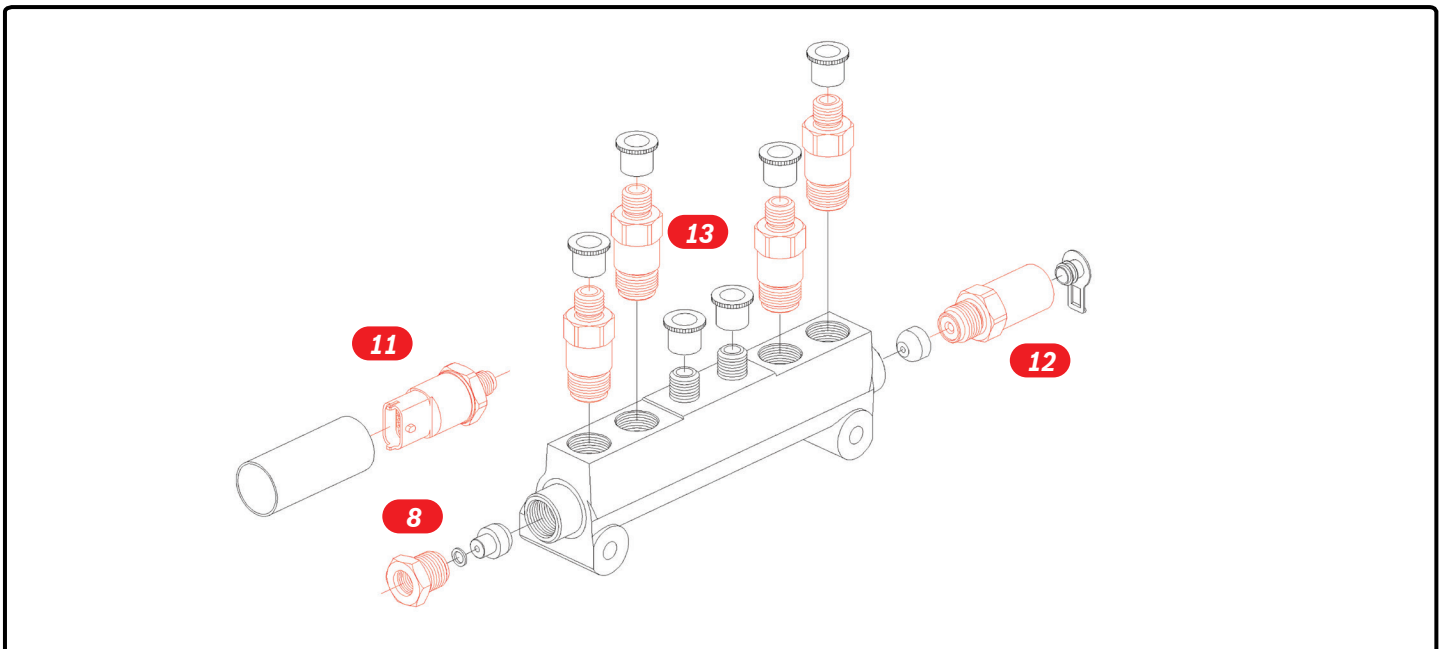
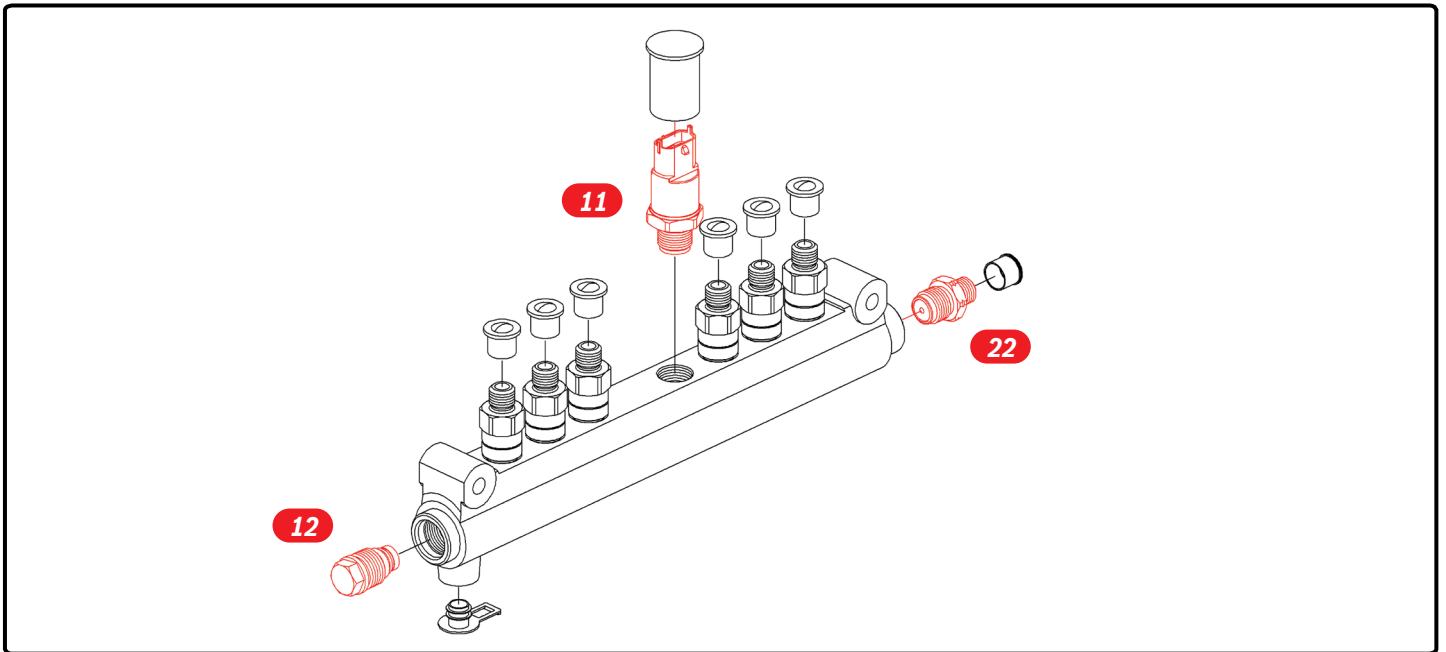
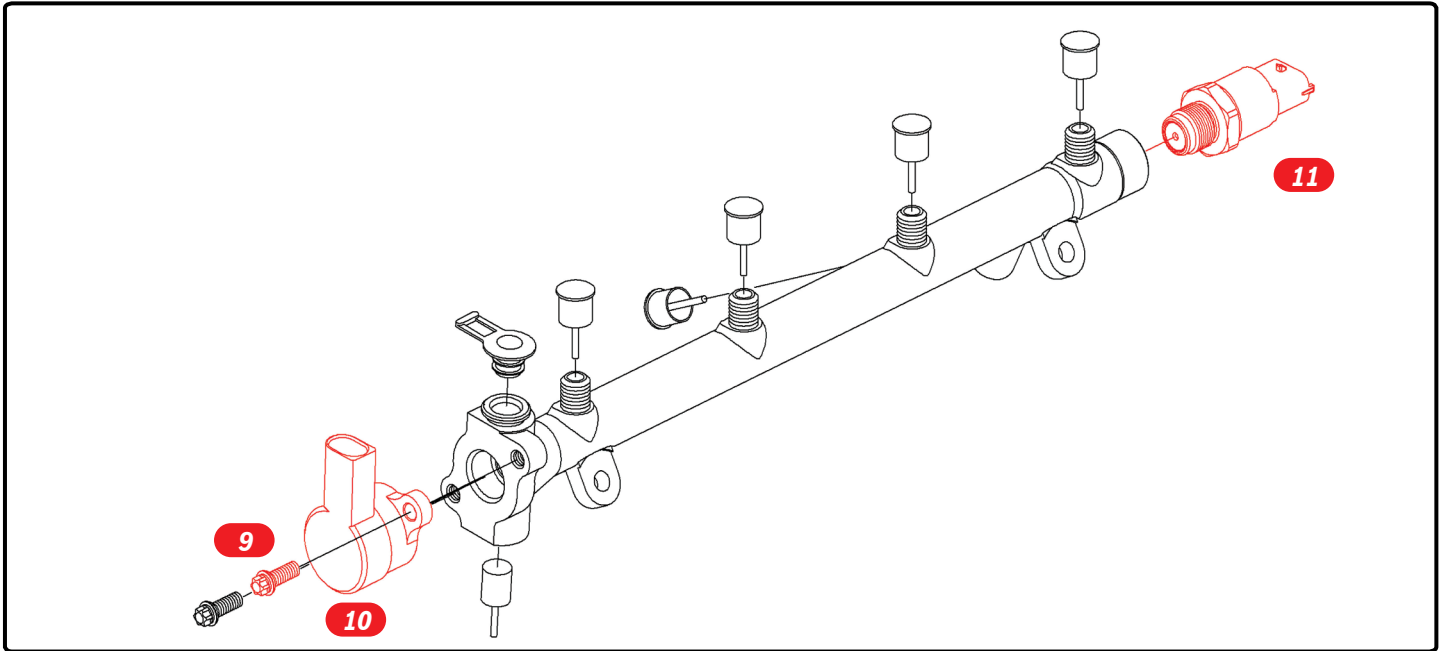

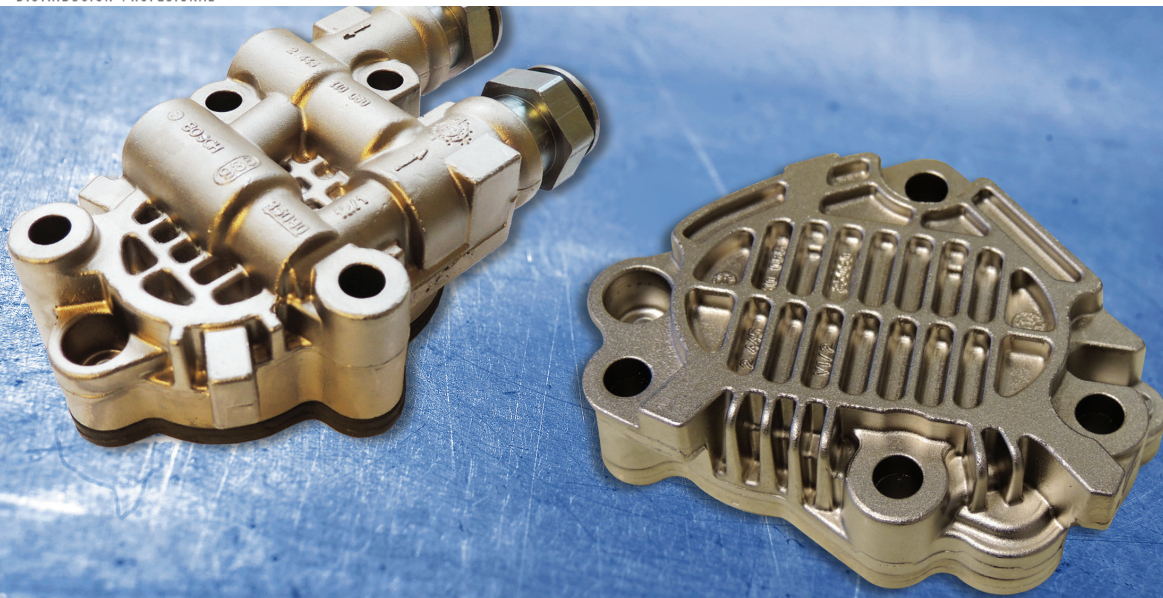

BOMBAS DE ENGRANAJES

Código	Nº de Pieza	Nº de Bomba	Aplicación
0 440 020 028	105	0 445 020 003-004 -009-010-012-013- 024-025-035-036	Bomba de engranaje Common Rail - Renault Midlum 270 DCI c/ motor 6A Euro 3.
0 440 020 030	85	0 445 020 054 - 015 - 151	Bomba de engranaje Common Rail - Sisu 74 / 84 - Cummins.
0 440 020 031	85	0 445 010 043 - 052 - 101 - 0 445 020 057	Bomba de engranaje Common Rail - CP3 Kia Sorento 2.5 CRDI - Hyundai H1 2.5 CRDI.
0 440 020 033	85	0 445 010 044-115	Bomba de engranaje Common Rail - Blazer 2.8 D.Electronic - S10 2.8 D. Electronic.
0 440 020 034	85	0 445 010 034 - 084 - 104	Bomba de engranajes Common Rail - Cherokee 2.5 TD.
0 440 020 039	85		Bomba de engranajes Common Rail - Renault Master 2.5 CDI 120/2.2 CDI90
0 440 020 047	400	0 445 020 019 0 445 020 033	Bomba de engranaje Common Rail - Ford Cargo Eco Torq VW Worker, Constellation.
0 440 020 077	85	0 445 020 056 - 083 - 119	Bomba de engranaje Common Rail - Sisu - Cummins - Deutz.
0 440 020 088	86	0 445 010 024 - 272	Bomba de engranaje Common Rail - M. Benz Sprinter 208 / 211 / 213 / 216 / 311 / 316 / 411 / 413 / 416 DCI / C200 / 220 DCI / E200 / 220 DCI.
0 440 020 095	400	0 445 020 007	Bomba de engranaje Common Rail - Ford Cargo C 1317E / 1517 E / 1717 E / C2422 / C2428 / C 2622 / C2628 E / F250 - Eurocargo 170E / 240E / 100 E17.

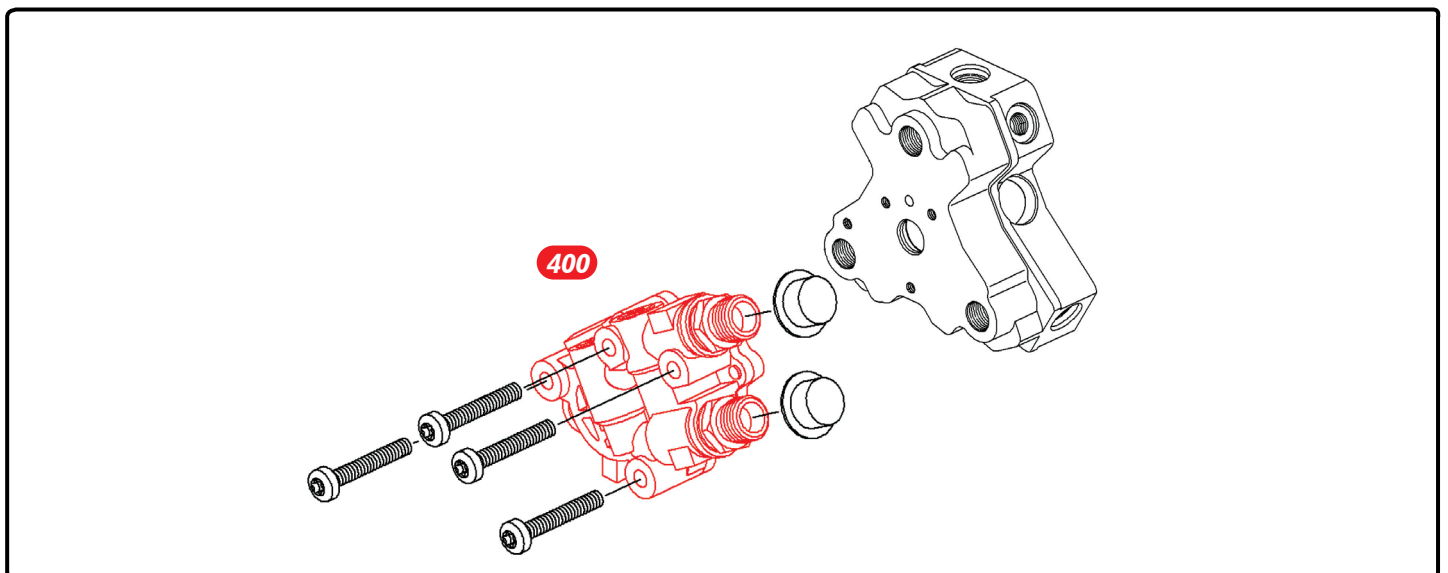
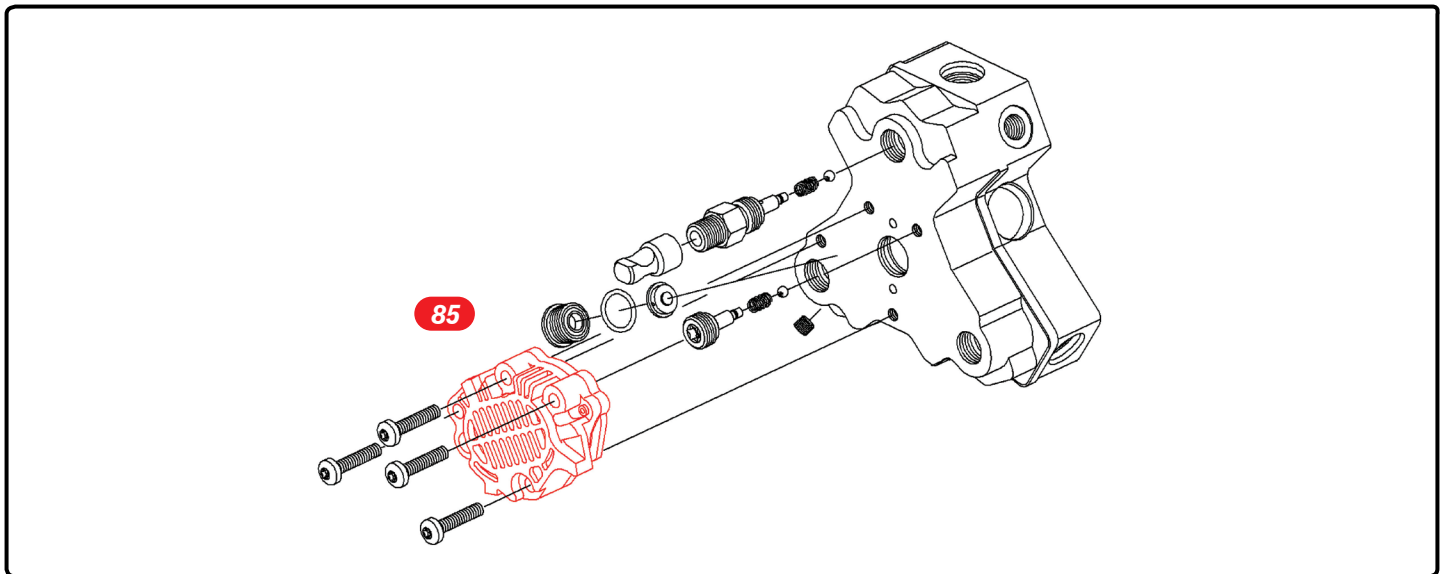
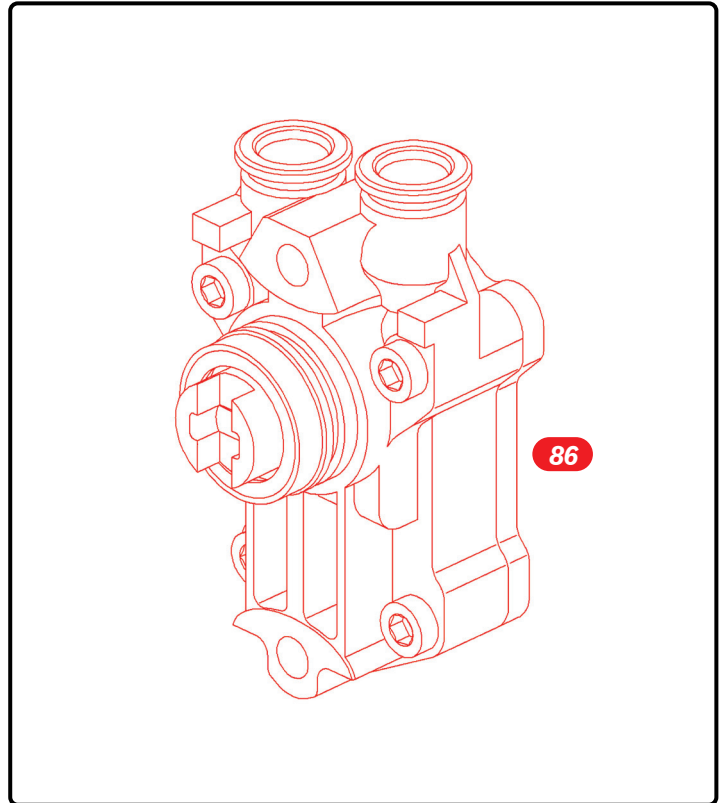
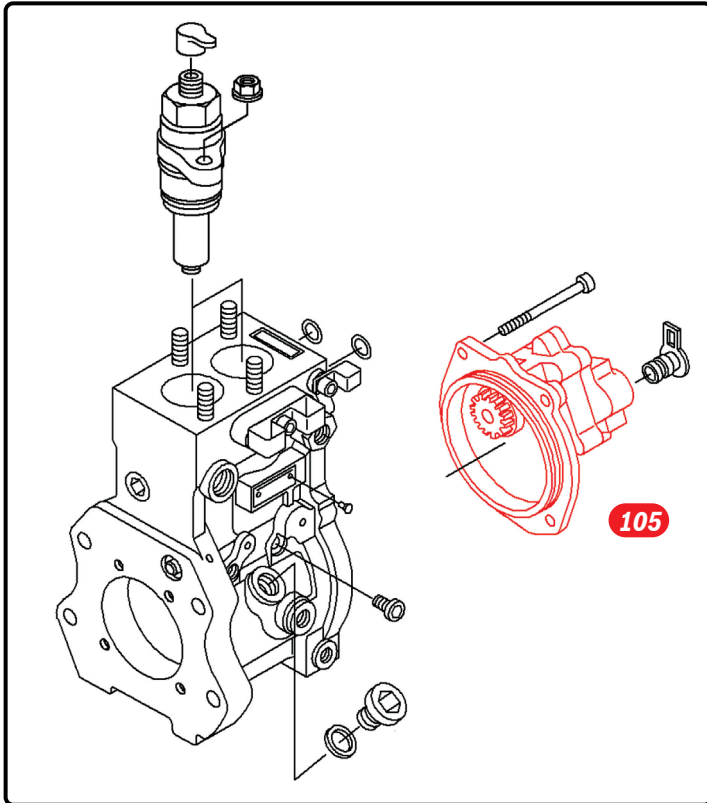



BOMBAS UNITARIAS UPS

:: BOMBAS COMPLETAS

Código	Aplicación
0 414 750 004	Bomba para motores Deutz 1013.
0 414 799 005	Bomba para M. Benz línea Axor OM457, 1835, 2035, M. Benz 19385, Actros OM541 1831, 1832, 2035.
0 414 799 008	Bomba para M. Benz línea Atego OM 904 / 906 Axor OM 902, 926.
0 414 799 015	Bomba para M. Benz línea Axor OM457 1835, 1840, 2035, 2540.... y Actros OM541 1831, 2035 2040.
0 414 799 018	Bomba para M. Benz línea Axor OM457, Actros Motor OM 541. Reemplazado x 0414799024 .
0 414 799 024	Bomba para M. Benz línea Axor OM457 2036, 2640, 3240, Actros Motor OM 541 2032, 2532, 3641, 4144.
0 414 755 003	Bomba para camiones Renault.
0 414 799 007	Bomba para M. Benz Axor 1835, 1840, 2535, OM 457, Actros 1848, 1850, 3350, OM542

DESPIECE DE BOMBAS UNITARIAS | ELECTROIMANES

Código	Nº de Pieza	Nº de Inyector	Aplicación
F00HN37431	7	0 414 799 005 - 0 414 799 008	Electroiman para bomba en general línea M. Benz Axor, Atego.

O' RINGS

Código	Nº de Pieza	Juego de reparación	Nº de Bomba	Aplicación
F 00H N37 621	17	No disponible	0414750004 / 0414799008	O' ring de cuerpo de bomba para motores Deutz, M. Benz línea Atego OM 904 / 906 Axor OM 902, 926. Reemplaza a F 00H N37 072.
F 00H N37 622	25	F 00H N37 070 - 454	0414799008	O' ring de cuerpo de bomba para M. Benz línea Atego OM 904 / 906 Axor OM 902, 926.
F 00H N35 985	26	F 00H N37 070	0414799008	O' ring de torinillo de fijación bomba M. Benz línea Atego OM 904 / 906 Axor OM 902, 926.
F 00H N35 932	17	F 00H N37 069	0414799005 / 007 / 015 / 018 / 024	O' ring de cuerpo de bomba para M. Benz línea Axor OM457, 1835, 1840, 2035, 2036, 2040, 2535, 3240 M. Benz 19385, Actros OM541 1831, 1832, 2032, 2035, 2040, 2532, 3641, 4144. Actros 1848, 1850, 3350, OM542.
		F 00H N37 759	0414755003	O' ring de cuerpo de bomba para camiones Renault.
F 00H N35 933	25	F 00H N37 069	0414799005 / 007 / 015 / 018 / 024	O' ring de cuerpo de bomba para M. Benz línea Axor OM457, 1835, 1840, 2035, 2036, 2040, 2535, 3240 M. Benz 19385, Actros OM541 1831, 1832, 2032, 2035, 2040, 2532, 3641, 4144. Actros 1848, 1850, 3350, OM542.
F 00H N37 008	6	F 00H N37 069	0414799005 / 007 / 015 / 018 / 024	O' ring de imán para M. Benz línea Axor OM457, 1835, 1840, 2035, 2036, 2040, 2535, 3240 M. Benz 19385, Actros OM541 1831, 1832, 2032, 2035, 2040, 2532, 3641, 4144. Actros 1848, 1850, 3350, OM542.
		F 00H N37 759	0414755003	O' ring de imán para camiones Renault.
		F 00H N37 070	0414799008	O' ring de imán bomba para M. Benz línea Atego OM 904 / 906 Axor OM 902, 926.
F 00H N35 723	4		0414750004	O' ring de imán bomba para motores Deutz.
		F 00H N37 069	0414799005 / 007 / 015 / 018 / 024	O' ring de tapa trasera de imán para M. Benz línea Axor OM457, 1835, 1840, 2035, 2036, 2040, 2535, 3240 M. Benz 19385, Actros OM541 1831, 1832, 2032, 2035, 2040, 2532, 3641, 4144. Actros 1848, 1850, 3350, OM542.
		F 00H N37 759	0414755003	O' ring de tapa trasera de imán para camiones Renault.
		F 00H N37 070	0414799008	O' ring de tapa trasera de imán bomba para M. Benz línea Atego OM 904 / 906 Axor OM 902, 926.
			0414750004	O' ring de tapa trasera de imán bomba para motores Deutz.
F 00H N36 345	25	F 00H N37 759	0414755003	O' ring de cuerpo de bomba para camiones Renault.

JUEGOS DE REPARACIÓN

Código	Nº de Pieza	Nº de Inyector	Aplicación
F 00H N37 069	801	0 414 799 001 - 005 - 009 - 018 - 024	Juego de piezas Inyector PLD - M . Benz Actros, Axor, 1831 - 1832 - 1835 - 1836 - 1840 - 841 - 1843 - 1844 - 1846 - 1848 - 850.
F 00H N37 070	801	0 414 799 003 - 004 - 008 - 014	Juego de piezas Inyector PLD - M . Benz 1215C - 1318 - 1718 M - L1418.
F 00H N37 454	800	0 414 799 003 - 008 - 014 - 028	Juego de O´ring Inyector PLD - Renault 1950 - 400 E Tech Magnum - Mack.
F 00H N37 759	801	0 414 755 002 - 003 - 006 - 007 - 014 - 015	Juego de piezas Inyector PLD - Renault 1950 - 400 E Tech Magnum - Mack. 0 414 755 002 - 003 - 006 - 007 - 014 - 015

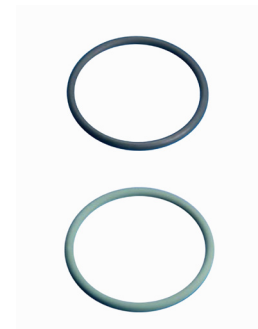

RESORTES

Código	Nº de Pieza	Nº de Inyector	Aplicación
F 00H N35 873	19	0 414 750 002 - 004	Resorte de compresión para bomba Línea Deutz 1013
F 00H N35 977	19	0 414 799 003 - 008	Resorte de compresión para bomba línea M. Benz Atego OM904 1215, 1418
F 00H N36 635	19	0 147 799 018 - 024 - 0 414 799 005	Resorte de compresión para bomba M. Benz Axor, Actros, 1835, 18140, 2540, OM 457

VARIOS



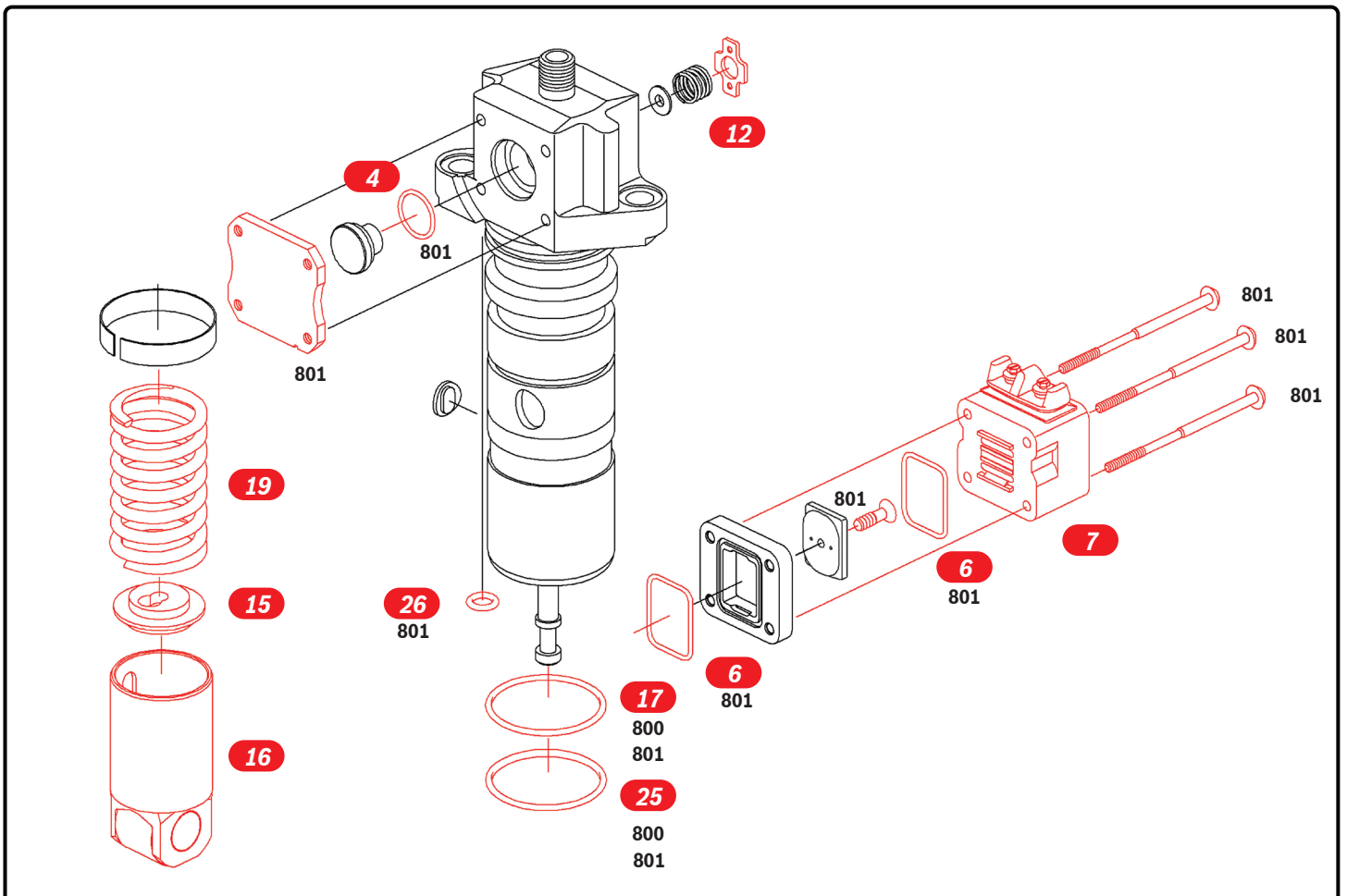

Código	Nº de Pieza	Nº de Inyector	Aplicación
F 00H N36 618	15	0 414 799 005 0 414 799 024	Platillo de resorte de compresión para bomba M. Benz Axor 1835, 18140, 2540, OM457, Actros.
F 00H N36 628	16	0 414 799 008	Botador 0414799003 para bomba M. Benz Atego, 1215, 1318, 1418, OM 904.
F 00H N37 391	12	0 414 755 002 0 414 799 008	Apoyo en cruz del Resortes de inducido bombas en general Renault Magnum , M. Benz Atego.
F 00H N37 402	16	0 414 799 005 0 414 799 015	Botador para bomba M. Benz Axor y Actros.





INYECTORES PLD

INYECTORES COMPLETOS

Código	Nº de Tobera	Aplicación	
0 432 191 240	0 433 171 978 DLLA 122P 1602	Inyector - M. Benz varios.	
0 432 191 258	0 433 171 741 DLLA 150P 1164	Inyector - M. Benz AXOR OM457, ACTROS OM541.	
0 432 191 260	0 433 171 676 DLLA 160P 1032	Inyector - M. Benz 1938 S, 1938 LS.	
0 432 191 269	0 433 171 741 DLLA 150P 1164	Inyector - M. Benz Axor 2035 OM 457.	
0 432 191 278	0 433 171 688 DLLA 156P 1059	Inyector - M. Benz Atego, 1228 -1528 - 1828 - 2628, Axor.	





Código	Nº de Tobera	Aplicación	
0 432 191 280	0 433 171 679 DLLA 147P 1048	Inyector - M. Benz Atego, 1418-1518-1718, Varios.	
0 432 191 301	0 433 171 680 DLLA 147P 1049	Inyector - M. Benz ATEGO OM 904.	
0 432 191 303	0 433 171 797 DLLA 144P 1264	Inyector - M. Benz Atego 1322-1833, Axor 1833-2533.	
0 432 191 326	0 433 171 780 DLLA P147 1230	Inyector - Omnibus motor Deutz.	
0 432 191 551	0 433 171 436 DLLA 160P 5577	Inyector - M. Benz línea AXOR OM457, ACTROS OM541.	
0 432 193 436	0 433 175 485 DSL A 146P 1730	Inyector - M. Benz Atego, Axor.	
0 432 193 441	0 433 175 483 DSL A 150P 1728	Inyector - M. Benz varios.	
0 432 193 445	0 433 175 483 DSL A 150P 1728	Inyector - M. Benz varios.	
0 432 193 480	0 433 175 416 DSL A 156P 1411	Inyector - M. Benz Atego OM 904.	
0 432 193 481	0 433 175 416 DSL A 156P 1411	Inyector - M. Benz Atego, Axor OM 906.	

DESPIECE DE INYECTORES PLD | TOBERAS

Código	Alfa numérico	Inyector	Aplicación
0 433 171 436	DLLA 160 P 577	0 432 191 551	Tobera para inyector PLD - M. Benz AXOR OM457, Actros OM541.
0 433 171 610	DLLA 150 P 916	0 432 191 372	Tobera para inyector PLD - M. Benz AXOR OM457, Actros OM541.
0 433 171 676	DLLA 160 P 1032+	0 432 191 260	Tobera para inyector PLD - M. Benz 1938 S, 1938 LS
0 433 171 679	DLLA 147 P 1048	0 432 191 280/396	Tobera para inyector PLD - M. Benz Atego, 1418-1518-1718, Varios
0 433 171 680	DLLA 147 P 1049	0 432 191 394	Tobera para inyector PLD - M. Benz ATEGO OM 904.
0 433 171 688	DLLA 156 P 1059	0 432 191 278	Tobera para inyector PLD - M. Benz Atego, 1228-1528-1828-2628, Axor
0 433 171 741	DLLA 150 P 1164	0 432 191 258	Tobera para inyector PLD - M. Benz AXOR OM457, Actros OM541.
0 433 171 780	DLLA 147 P1230	0 432 191 326	Tobera para inyector PLD - Deutz
0 433 171 797	DLLA 144 P 1264	0 432 191 303	Tobera para inyector PLD - M. Benz Atego 1322-1833, Axor 1833-2533
0 433 171 978	DLLA 122 P 1602	0 432 191 240	Tobera para inyector PLD - M. Benz varios
0 433 171 986	DLLA 150 P 1614	0 432 191 219	Tobera para inyector PLD - M. Benz AXOR OM457, Actros Motor OM 541. Reemplazado x 0414799024
0 433 175 416	DSLA 156 P 1411	0 432 193 480	Tobera para inyector PLD - M. Benz ATEGO OM 904.
0 433 175 483	DSLA 150 P 1728	0 432 193 441 / 445	Tobera para inyector PLD - M. Benz varios.
0 433 171 484	DSLA 155 P 665	0 432 131 715	Tobera para inyector PLD - Motor Cummins.
0 433 175 485	DSLA 146 P 1730	0 432 193 436	Tobera para inyector PLD - M. Benz Atego.
0 433 175 518	DSLA 153 P 5518	0 432 193 419	Tobera para inyector PLD - M. Benz AXOR OM457, Actros Motor OM 541. Reemplazado x 0414799024

VARIOS

Código	Nº de Pieza	Nº de Inyector	Aplicación
F 00Z Z20 003	6	0 432 191 219 - 220 - 303 0 432 193 436 - 445 - 481	Plaqueta intermedia Cummins 6BTAA, M. Benz 1938 electrónico PLD. 0 432 191 219 - 220 - 303, 0 432 193 436 - 445 - 481
F 00Z M20 000	124	0 432 191 219 - 220 - 303 0 432 193 436 - 445 - 481	Arandela de perno de presión, para inyectores varios, M. Benz Atego, Axor. 0 432 191 219 - 220 - 303, 0 432 193 436 - 445 - 481



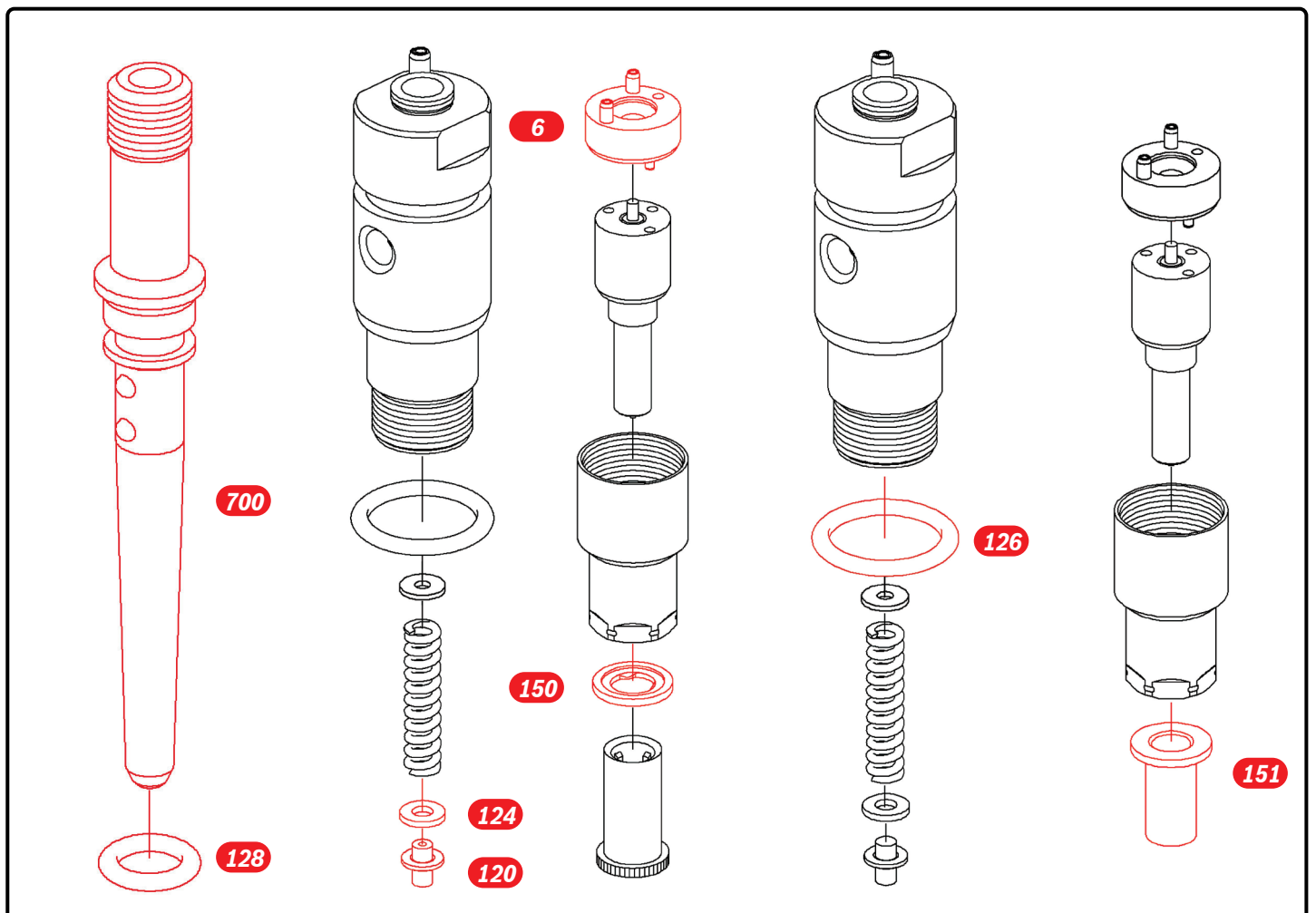

Código	Nº de Pieza	Nº de Inyector		
2 430 105 049	150	0 432 191 394	Arandela de asiento de tobera M. Benz Atego.	
2 430 210 081	126	0 432 191 219	O´Ring de inyector MB 1938, Atego, Axor.	
2 430 210 082	128	0 432 191 219	O´Ring de cánula de inyector MB 1938, Atego, Axor.	
F 00Z B20 002	120	0 432 191 219	Perno de presión de inyector MB 1938, Atego, Axor.	
F 00Z W00 003	151	0 432 191 219 - 220 - 303 0 432 193 436 - 445 - 481	Manguito protector antitérmico sistema UPS/PLD. M. Benz Atego 1016, 1222, 1226, OM924, M. Benz Axor 1836, 2540, 2640, OM457.	













SISTEMAS UIS / PDE

INYECTORES PDE

Código	Nº de Tobera	Kit	Aplicación	
0 414 700 002	0 433 171 439 DLLA 145 P 580	-	Inyector - Iveco Stralis, Euro Trakker, Euro Tech.	
0 414 700 003	0 433 171 596 DLLA 143 P 894	-	Inyector - Iveco Stralis, Euro Trakker, Euro Tech. Reemplazado x 0414700009 .	
0 414 700 009	0 433 171 596 DLLA 143 P 894	-	Iveco 180 E 32/33-450E33T Eurotech / Trakker / Stralis. Reemplaza a 0414700003 .	
0 414 701 004	0 433 171 433 DLLA 155 P 572	-	Inyector - Volvo serie B12,FH12,FL12.	

Código	Nº de Tobera	Kit	Aplicación	
0 414 701 005	0 433 171 470 DLLA 150 P 635	-	Inyector - Scania serie K,P,T 124.	
0 414 701 017	0 433 171 470 DLLA 150 P 635	-	Inyector - Scania serie P,T 114.	
0 414 701 020	0 433 171 575 DLLA 150 P 847	-	Inyector - Scania serie R164,R500,7164,T500.	
0 414 701 021	0 433 171 564 DLLA 140 P 826	-	Inyector - Iveco CURSOR, Case.	
0 414 701 032	0 433 171 786 DLLA 150 P 1239	-	Inyector - Scania. DI 12m, DI 16m, DC 16.40, DC 16.41, DC 16.42.	
0 414 701 035	0 433 171 799 DLLA 150 P 1269	-	Inyector - Scania DC 16.43.	
0 414 701 052	0 433 171 631 DLLA 140 P 947	-	Inyector - Iveco Stralis, Euro Trakker, Euro Tech. Reemplazado x 0414701013 .	
0 414 701 068	0433171799 DLLA150P1269	-	Inyector Bomba UIS/PDE Scania DS 16	

INYECTORES PDE

Código	Nº de Tobera	Kit	Aplicación	
0 414 702 002	0 433 171 584 DLLA 155 P 872	-	Inyector - Volvo serie B12,FH12,CH5000 12 litros.	
0 414 702 007	0 433 171 621 DLLA 152 P 932	-	Inyector - Volvo serie FH12, FM12 12,1 litros.	
0 414 702 010	0 433 171 584 DLLA 155 P 872	-	Inyector - Volvo serie FH12/420, FM12/420 12,1 litros.	
0 414 703 004	0 433 171 937 DLLA 145 P 1517	-	Inyector - Iveco Stralis, Trakker.	
0 414 703 009	0 433 171 957 DLLA 140 P 1551	-	Inyector - Iveco Stralis 260/440 S43, CASE cosechadora serie 8000, Trakker.	
0 414 720 038	0 433 175 306 DLLA 150 P 1045	1 417 010 988	Inyector - VW Sharan 1.9 Tdi. Reemplazado x 0414720088 .	
0 414 720 039	0 433 175 304 DSL A 150 P 1043	1 417 010 987	Inyector - VW Passat y Bora 1.9 Tdi, Audi A3, Sea Ibiza, Leon, Toledo.	
0 414 720 087	0 433 175 199 DSL A 150 P 800	1 417 010 989	Inyector - VW Passat y Bora, Golf IV 1.9 TDi, Audi A3 - A4, Seat Ibiza.	

Código	Nº de Tobera	Kit	Aplicación	
0 414 720 088	0 433 175 306 DSLA 150 P 1045	1 417 010 988	Inyector - VW Sharan 1.9 TDI.	
0 414 720 215	0 433 175 367 DSLA 150 P 1247	1 417 010 984	Inyector - VW Bora Touran, Transporte, Vento, GOLF V 1.9 Tdi, Audi A2-A3, Seat Ibiza. Reemplazado x 0414720265 .	
0 414 720 216	0 433 175 368 DSLA 150 P 1248	1 417 010 983	Inyector - VW Sharan y Passat 1.9 Tdi. Audi A4-A6, Seat Ibiza.	
0 414 720 223	0 433 175 407 DSLA 150 P 1362	1 417 010 979	Inyector - VW Bora.	
0 414 720 265	0 433 175 367 DSLA 150 P 1247	1 417 010 984	Inyector - VW Bora Touran, Transporte, Vento, Golf V 1.9 Tdi. Audi A2-A3, Seat Ibiza, Leon, Toledo. Reemplaza a 0414720215.	
0 414 720 404	0 433 175 379 DSLA 152 P 1287	1 417 010 969	Inyector - VW Touran, Golf V, Vento 2.0 Tdi. Audi A3-A4-A6, Mitsubishi Lancer. Reemplazado x 0414720454 .	
0 414 720 454	0 433 175 379 DSLA 152 P 1287	1 417 010 969	Inyector - Audi A3, A4, A6, VW Golf, Touran, Mitsubishi Lancer. Reemplaza a 0414720404.	

DESPIECE DE INYECTORES PDE | TOBERAS

Código	Alfa numérico	kIT (tobera, discos intermedio, portatobera)	Inyector	Aplicación
0 433 171 433	DLLA 155 P 572	-	0414701004	Inyector Volvo serie B12, FH12, FL12
0 433 171 439	DLLA 145 P 580	-	0414700002	Inyector Iveco Stralis, Euro Trakker, Euro Tech
0 433 171 470	DLLA 150 P 635	-	0414701005	Inyector Scania serie K, P, T 124
			0414701017	Inyector Scania serie P, T 114
0 433 171 564	DLLA 140 P 826	-	0414701021	Inyector Iveco CURSOR, Case
0 433 171 575	DLLA 150 P 847	-	0414701020	Inyector Scania serie 420, R164, R500, 7164, T500
0 433 171 576	DLLA 150P 848	-	0414701008	Scania 114 / 340 / 380.
0 433 171 584	DLLA 155 P 872	-	0414702002	Inyector Volvo serie B12, FH12, CH5000 12 litros
			0414702010	Inyector Volvo serie FH12/ 420, FM12/420 12,1 litros
0 433 171 596	DLLA 145 P 894	-	0414700003	Inyector Iveco Stralis, Euro Trakker, Euro Tech
0 433 171 621	DLLA 152 P 932	-	0414702007	Inyector Volvo serie FH12, FM12 12,1 litros. Motor D12 / D380 / 480
0 433 171 631	DLLA 140 P 947	-	0414701052	Inyector Iveco Stralis, Euro Trakker, Euro Tech
0 433 171 786	DLLA 150 P 1239	-	0414701032	Inyector Scania 15.6 litros / DC 16.40A / 16.41A
0 433 171 919	DLLA 150P 1487	-	0414701036	Scania F230 Motor DC9
0 433 171 957	DLLA 140 P 1551	-	0414703009	Inyector Iveco Stralis 260/440 S43, CASE cosechadora serie 8000
0 433 172 232	DLLA 148P 2232	-	0414701051	Scania P360 electrónico.
0 433 175 199	DSLA 150 P 800	1 417 010 989	0414720087	Inyector VW Passat y Bora, Golf IV 1.9 TDi
0 433 175 306	DSLA 150 P 1045	1 417 010 988	0414720038	Inyector VW Sharan 1.9 Tdi / Bora 1.9 - Audi A4 1.9.
0 433 175 304	DSLA 150 P 1043	1 417 010 987	0414720039	Inyector VW Passat y Bora 1.9 Tdi motor ARL
0 433 175 367	DSLA 150 P 247	1 417 010 984	0414720215	Inyector VW Touran, Transporte, Vento, GOLF V 1.9 Tdi Motor AXR
			0414720265	Inyector VW Touran, Transporte, Vento, GOLF V 1.9 Tdi Motor AXR
0 433 175 368	DSLA 150 P 1248	1 417 010 983	0414720216	Inyector VW Sharan y Passat 1.9 Tdi Motor AVF / AWX
0 433 175 407	DSLA 150 P 1362	1 417 010 979	0414720223	Inyector VW Bora New Beetle 1.9 TDI nº comercial 273 Motor BEVS

Código	Alfa numérico	kIT (tobera, discos intermedio, portatobera)	Inyector	Aplicación
0 433 175 379	DSLA 152 P 1287	1417010969	0414720404	Inyector VW Touran, GOLG V, Vento 2.0 Tdi
			0414720454	Inyector VW Touareg, Vento, Audi A3 A4 A6 2.0 TDI
0 433 175 429	DSLA 148P 1468	1417010974	0414720228	VW Tuareg 2.5 TDI

TUERCAS PORTA TOBERAS

Código	Nº de Pieza	Nº de Inyector	Aplicación
F 00H 410 541	34	0 414 703 009 0 414 703 013	Tuerca porta tobera Inyector Iveco Stralis – Case Cursor
F 00H N36 515	34	0 414 700 002	Tuerca porta tobera Inyector Iveco Eurotech, Eurotrakker, Stralis
F 00H N37 192	36	0 414 702 007	Tuerca porta tobera Inyector y varios Volvo FH12, FN12, 420
F 00H N37 345	36	0 414 701 005	Tuerca porta tobera Inyector y varios Scania K124, P124, R114, T114
F 00H N37 591	34	0 414 701 052	Tuerca porta tobera Inyector y varios Iveco Stralis, Eurotech, Eurotrakker.

ELECTROIMANES





Código	Nº de Pieza	Nº de Inyector	Aplicación
F 00H N37 925	803	0 414 700 002 0 414 700 007	Juego de piezas del solenoide (completo) Inyector PDE - Iveco EuroMover 190 - 260 E24 - Euro Tech 190 - 190 E24 - 260 E24 -27 - Euro Trakker 180 E24.
F 00H N37 933	803	0 414 701 004 0414 702 007	Juego de piezas del solenoide (completo) Inyector PDE- Volvo B12 CH 5000 - NH 12 380.
F 00H N37 934	803	0 414 701 021	Juego de piezas del solenoide (completo) Inyector PDE - Iveco Euro Mover 190 E24 - Euro Trakker 180 E24 - 190 E24 - 260 E 31 - 340 E 35.



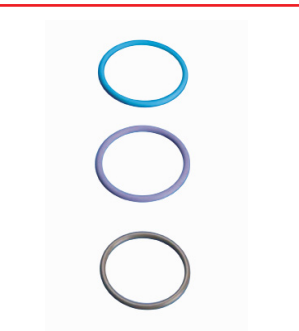
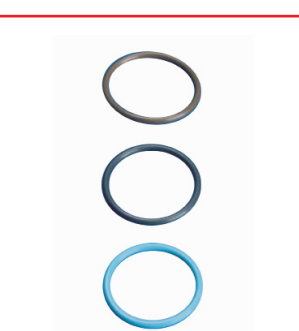

JUEGOS DE REPARACIÓN

Código	Nº de Pieza	Nº de Inyector	Aplicación	
F 00H N37 928	802	0 414 701 004	Juego de anillos del solenoide Inyector PDE - Iveco Euro M. 190 - 260 E24 - EuroTech 190 -260 E24 - Scania K124 / 420 - 124EB - P124 / 420.	
F 00H N37 926	28	No disponible	Juego de piezas (Resorte y tope de presión) Inyector PDE - Scania - Iveco - Volvo.	
F 00V X99 886	801	0 414 701 017 0 414 701 020	Juego de piezas del émbolo (18mm) Inyector PDE - Scania K 124EB - P,R114/340 /380 - P,R 124/420 - T 114/340 /380 - G230 -270 - 310 - P230 -270 - 310.	
F 00V X99 887	801	0 414 702 002 0 414 701 007	Juego de piezas del émbolo Inyector PDE -Volvo B12 CH 5000 - FH12380.	
F 00V X99 992	800	0 414 702 007 0 414 701 010	Juego de anillos externos Porta Tobera Inyector PDE - Volvo FH 12 420 - 340 - 380 - 425 - 460.	

JUEGOS DE REPARACIÓN

Código	Nº de Pieza	Nº de Inyector	Aplicación	
F 00V X99 993	801	0 414 700 002 0 414 700 003	Juego de piezas del émbolo (sin esfera) Inyector PDE - Iveco EuroMover 190/260 E24 - EuroTech 190 - E24 -E27 - E31 -E35 - EuroTrakker 180 E24.	
F 00V X99 994	801	0 414 701 005	Juego de piezas del émbolo (15mm) Inyector PDE - Scania K 124EB - P,R114/340/380 - P,R 124/420 - T 114/340/380 - G230 -270 - 310 - P230 -270 - 310.	
F 00V X99 995	800	0 414 701 021	Juego de anillos externos Porta Tobera Inyector PDE - Iveco Stralis 450 S 38T - Trakker 380 T 42.	
F 00V X99 996	800	0 414 700 002	Juego de anillos externos Porta Tobera Inyector PDE - Iveco EuroTech 190 - E24 - E27 - E31 - E35 - 260 E24 - E27 - E31 - E35 - 440 E 31 - E35 - Euro Trakker 180 E 24.	
F 00V X99 997	801	0 414 701 004	Juego de piezas de émbolo (sin esfera) Inyector PDE - Volvo 951 - 952 - 954 B12 CH5000.	

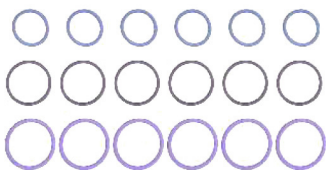
Código	Nº de Pieza	Nº de Inyector	Aplicación	
F 00V X99 998	800	0 414 701 005	Juego de anillos externos Porta Tobera Inyector PDE - Volvo B12 CH 5000 - FH 12 340 - 380 - 420 - NH 12 380.	
1 417 010 996	800	0 414 720 404	Juego de o´rings VW, Audi, Seat, Mitsubishi.	
1 417 010 997	804	0 414 720 215	Juego de reparación de inyector Bora, Vento.	
F 00V X99 999	800	0 414 701 005 0 414 701 017 0 414 701 020	Juego de o´rings Scania serie K, P, T124, 114, R164, R500.	

JUEGOS DE REPARACIÓN 3° ETAPA

Código	Espesor
Discos Guía.	
1 410 157 415	3,1750
1 410 157 416	3,1800
1 410 157 417	3,1850
1 410 157 418	3,1900
1 410 157 419	3,1950
1 410 157 420	3,2000
1 410 157 421	3,2050
1410157544	3,1650
1410157545	3,1700
1410157546	3,1750
1410157547	3,1800
1410157548	3,1850
1410157549	3,1900
1410157550	3,1950
1410157551	3,2000
1410157552	3,2050
1410157553	3,2100
1410157554	3,2150
1410157555	3,2200
1410157556	3,2250
1410157557	3,2300
1410157645	3,2350
1410157646	3,2400
Acumulador.	
1410337219	
Vaso Magnético.	
1414157014	
1414157017	

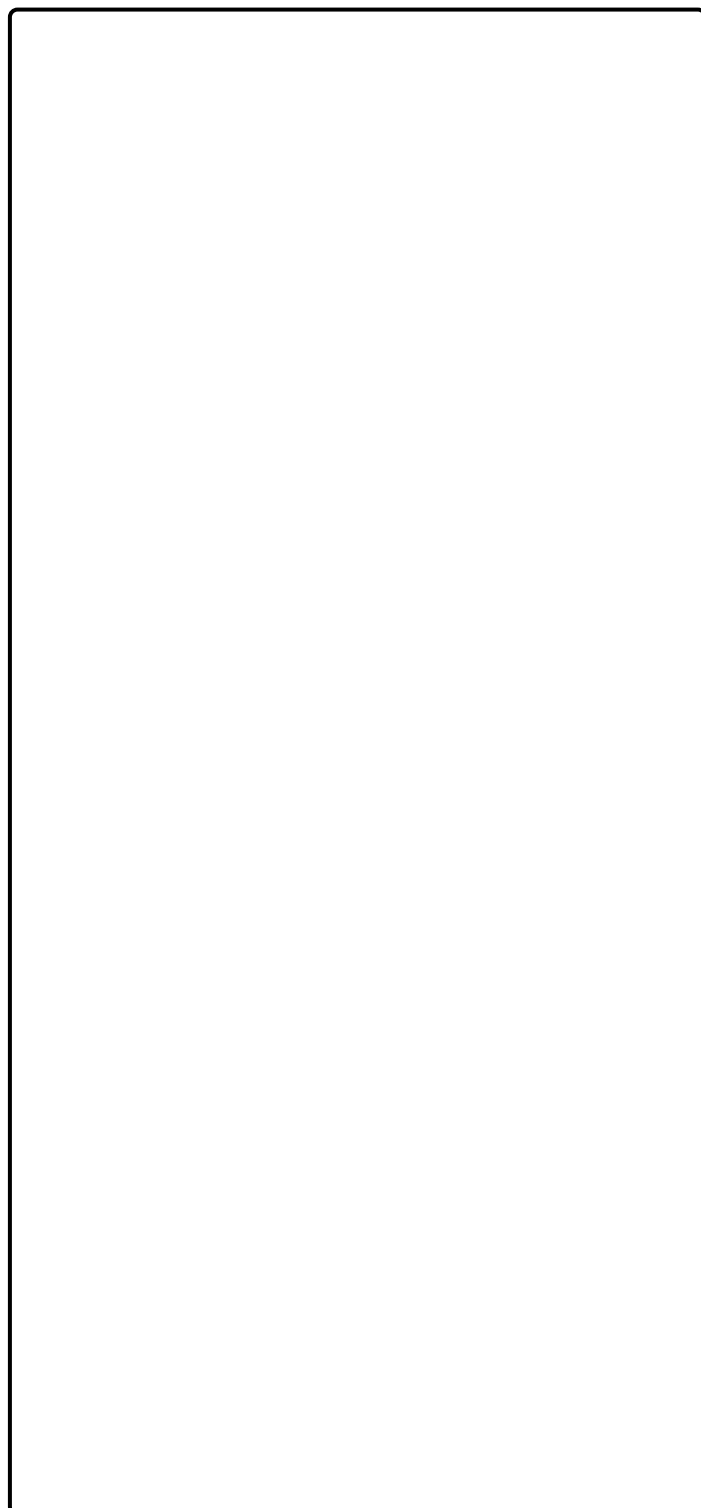

O'RINGS

Código	Nº de Pieza	Nº de Inyector	Nº de Juego	Aplicación
F 00H N35 728	37	0 414 701 004 - 005	F 00V X99 998	O´ring inferior de cuerpo para Inyectores Volvo - Scania, se provee en el kit.
F 00H N37 149	38	0 414 701 005	F 00V X99 999	O´ring superior tuerca Inyector Scania, se provee en el kit.
F 00H N37 150	39	0 414 701 005	F 00V X99 999	O´ring inferior tuerca Inyector Scania, Scania K 124, P124, T124.
F 00H N37 195	24	0 414 701 005	F 00H N37 927	O´ring interno de tuerca porta tobera Inyector y varios Scania K124, P124, T124.

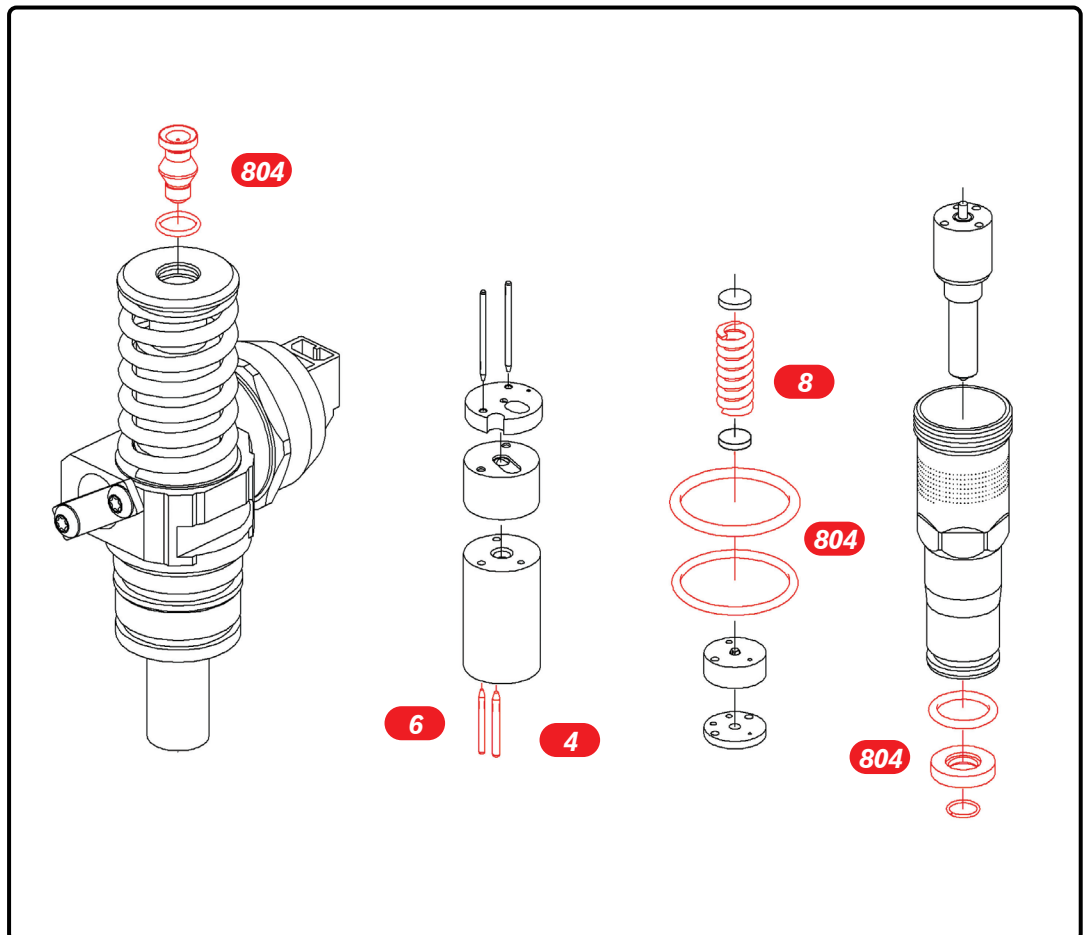
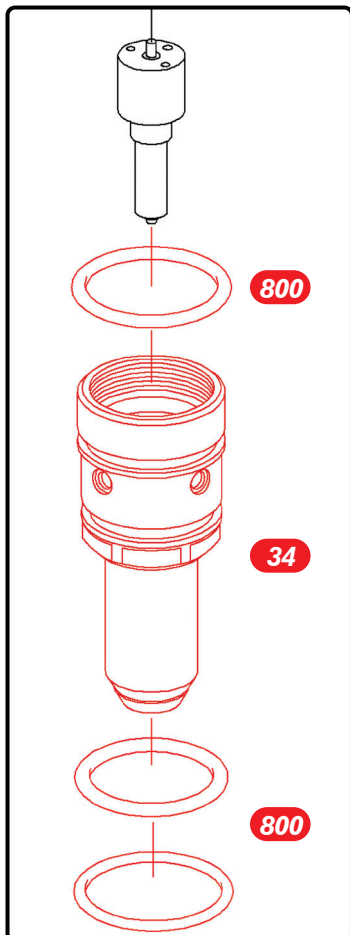
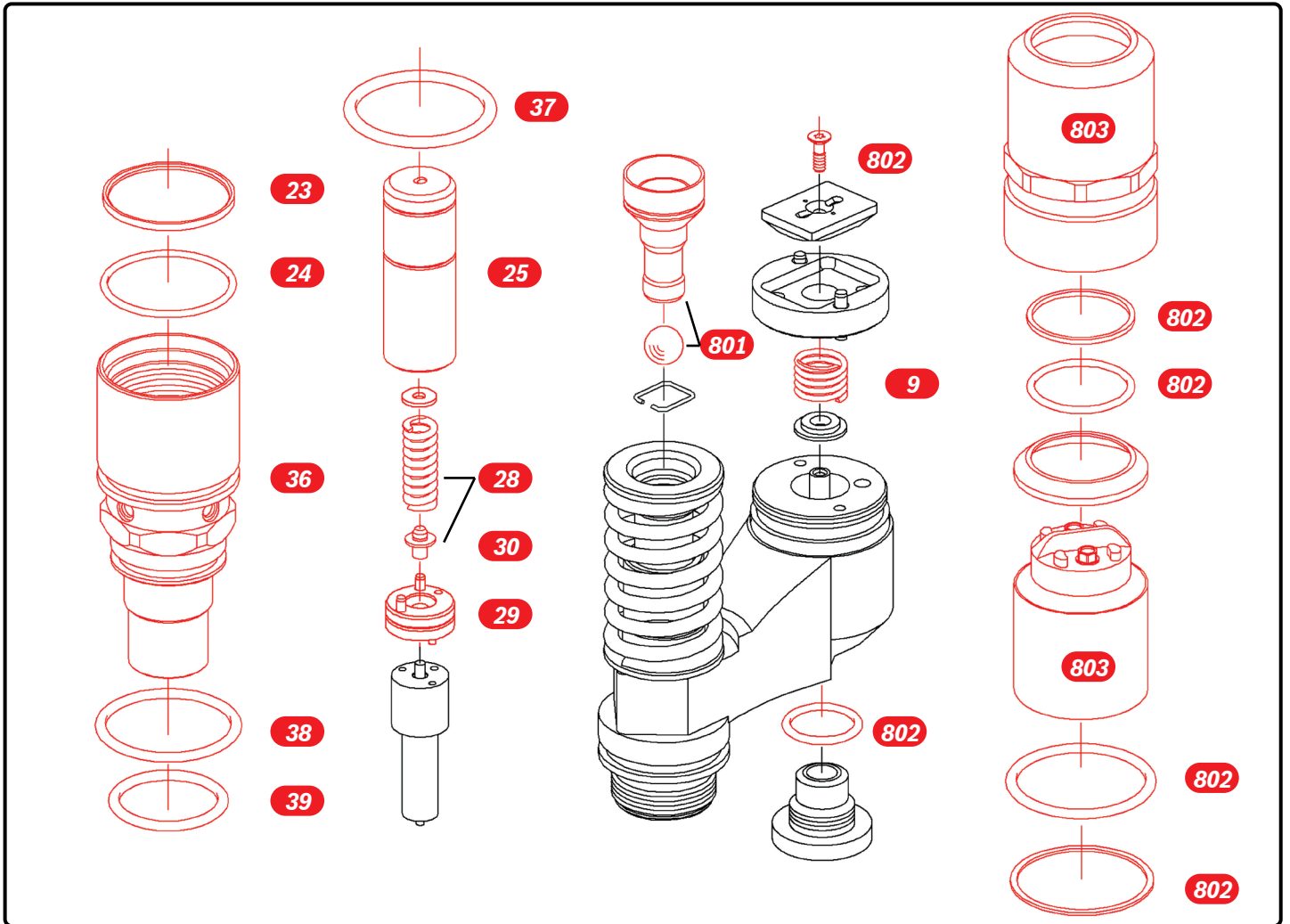

VARIOS

Código	Nº de Pieza	Nº de Inyector	Aplicación
F 00H 410 538	25	0 414 703 009 0414 703 013	Portaplumas (casquillo porta plaqueta y pico de presión) Inyector Iveco Stralis-Case.
F 00H N34 385	9	0 414 700 002	Resorte de válvula para Inyector Iveco Stralis-Scania-Volvo.
F 00H N37 343	23	0 414 701 005	Anillo de apoyo interno de tuerca porta tobera Inyector Scania.
F 00H N37 588	25	0 414 701 052	Portaplumas (casquillo porta plaqueta y pico de presión) Inyector Iveco.
F 00H N37 763	25	0 414 701 038	Portaplumas (casquillo porta plaqueta y pico de presión) Inyector varios Scania R500.
F 00Z B20 001	30	0 414 700 002	Tope de presión Inyector PDE Iveco Stralis Eurotrakker, Eurotech. Reemplaza a 2433124378.
F 018 B06 804	29	0 414 700 002	Disco intermedio Inyectores PDE varios, Scania, Iveco Eurotrakker, Eurotech y Volvo.
1 413 127 016	4	0 414 720 039	Pasador cilíndrico VW Passat, Bora, Audi A3 - A4.
1 413 127 017	6	0 414 720 039	Pasador cilíndrico VW Passat, Bora, Audi A3 - A4.
1 414 614 016	8	0 414 720 215	Resorte de tobera VW Bora, Touran, Transporter.
1 414 614 023	8	0 414 720 404	Resorte de tobera VW Touran, Vento.





PERIFÉRICOS

Código	Aplicación	
0 261 210 151	Sensor de cigüeñal número de revoluciones Renault Midlum 270 - Premium.	
0 281 002 046	Sensor de temperatura de aire – Iveco Stralis, Eurocargo, Eurotrackker - Scania 113.	
0 281 002 165	Sensor de cigüeñal número de revoluciones - Iveco Eurotrackker, Eurotech, Stralis.	

Código	Aplicación	
0 281 002 170	Sensor de temperatura de agua - Chevrolet Cruze – Citroën Juniper 2.8 HDI, Fiat Ducato 2.8, Iveco Daily, Peugeot Boxer 2.8.	
0 281 002 177	Sensor de presión de temperatura VW Bora/Passat/POLO 1.9 Audi A2, A6 Avant con sistema UIS VW Bora con UIS.	
0 281 002 180	Sensor Chevrolet Vectra 20DTH 2.0 LT / Astra.	
0 281 002 199	Medidor de masa de aire - A. Romeo 156 1.9 2.4 JTD.	
0 281 002 202	Sensor de posición de pedal de marcha. - A. Romeo 166 2.4 JTD.	

PERIFÉRICOS

Código	Aplicación	
0 281 002 203	Sensor de posición de pedal de marcha A. Romeo 145, 146, 156 1.9, 2.4 JTD.	
0 281 002 205	Sensor de presión de temperatura - Iveco Daily, Land Rover Defender, Discovery con UIS.	
0 281 002 209	Sensor de temperatura de agua Chevrolet S 10, Blazer motor MWM - Fiat Bravo, Ducato - Ford Cargo - Renault Midlum - VW Constellation. Iveco Stralis con motor F3B Cursorsr 1.3	
0 281 002 213	Sensor de árbol de levas A. Romeo, Fiat Bravo, Marea, Stilo, Strada.	
0 281 002 214	Sensor de cigüeñal (RPM) A. Romeo - Chevrolet, Blazer, S10 - Fiat Bravo, Marea, Stilo, Strada - Ford Cargo - VW Constellation, Worker.	

Código	Aplicación	
0 281 002 215	Sensor de presión de sobrealimentación A. Romeo, Fiat Bravo, Marea, Punto 1.9 JTD.	
0 281 002 216	Medidor de masa de aire - Audi A4 A6 - Seat Cordoba, Ibiza - VW Passat, Transporter, todos 1.9 TDI.	
0 281 002 232	Sensor de temperatura de agua - Iveco Stralis / Daily Class 2.8	
0 281 002 244	Sensor de presión de temperatura - M. Benz Atego / 1718 / 1725 / 1418 / Axor / 1933.	
0 281 002 308	Medidor de masa de aire - A. Romeo 147 - Fiat Marea, Palio, Strada, Stilo 1.9 TDI.	

PERIFÉRICOS

Código	Aplicación	
0 281 002 309	Medidor de masa de aire - A. Romeo 156, 166 - Fiat Marea, Bravo, Punto.	
0 281 002 315	Sensor de cigüeñal (RPM) - Iveco Stralis, Trackker - Renault Midlum, Premium. 0 445 010 177 (B. Alta Presión CP1)	
0 281 002 316	Sensor de presión de temperatura - Ford Cargo / F 250 - Iveco Eurocargo - Renault Midlum, Premium	
0 281 002 332	Sensor de cigüeñal - Citroën Jumper - Fiat Ducato - Iveco Daily - Peugeot Boxer.	
0 281 002 334	Módulo de pedal de acelerador - M. Benz Sprinter.	

Código	Aplicación	
0 281 002 384	Medidor de masa de aire - M. Benz C200 / C220.	
0 281 002 399	Sensor de presión de sobrealimentación - Audi A2, A3, A4, A6 - Seat Cordoba / Ibiza / Leon - VW Bora Passat / New Beetle.	
0 281 002 401	Sensor de presión de temperatura - Audi A2, A3, A4, A6 Q5, TT - Seat Cordoba / Ibiza / Leon / Toledo - VW Passat / Sharan / Tiguan / Transporter.	
0 281 002 410	Sensor de cigüeñal (RPM) - Ford Cargo / F 250 - Iveco Eurocargo - VW Constellation / Worker.	
0 281 002 411	Sensor de cigüeñal (RPM) - Ford Cargo / F 250 - Iveco Eurocargo - VW Constellation / Worker.	

PERIFÉRICOS

Código	Aplicación	
0 281 002 420	Sensor de presión de temperatura - Ford Cargo / F 250 - Iveco Eurocargo - VW Constellation / Worker.	
0 281 002 437	Sensor de presión de temperatura - Fiat Idea / Stilo / Strada.	
0 281 002 461	Medidor de masa de aire - Audi A3 / A4 / A6 - Seat Ibiza / Leon / Toledo - VW Bora / Passat / Sharan / Touareg.	
0 281 002 468	Sensor de presión de sobrealimentación - M. Benz Atego / Axor.	
0 281 002 471	Sensor de temperatura de agua - Ford Cargo / F 250 - Iveco Eurocargo - VW Constellation / Worker.	

Código	Aplicación	
0 281 002 474	Sensor de cigüeñal (RPM) - Ford Cargo / F 250 - Iveco Eurocargo - VW Constellation / Worker - A. Romeo 147 - Fiat Marea / Palio/ Strada/ Stilo.	
0 281 002 510	Sensor de presión de sobrealimentación - A. Romeo 147 - Fiat Punto/ Stilo.	
0 281 002 514	Sensor de presión de temperatura - Chevrolet Blazer/ S 10 - Citroën Jumper - Fiat Ducato - Iveco Daily - Peugeot Boxer.	
0 281 002 531	Medidor de masa de aire - Audi/ A3/ A4 - Seat Cordoba/ Ibiza/ Leon - VW Bora/ Fox / New Beetle / Touran.	
0 281 002 552	Sensor de presión de sobrealimentación - Renault Clio III / Laguna II / Traffic.	

PERIFÉRICOS

Código	Aplicación	
0 281 002 554	Medidor de masa de aire - Kia Sorento.	
0 281 002 566	Sensor de presión de sobrealimentación - Fiat Punto - Renault Clio III / Laguna II / Traffic / Megane II.	
0 281 002 567	Medidor de masa de aire - BMW 316 / 318 / 320.	
0 281 002 571	Medidor de masa de aire - Chrysler PT Cruiser.	
0 281 002 573	Sensor de presión de temperatura - Renault Clio II / Clio III / Master / Megane / Scenic.	

Código	Aplicación	
0 281 002 576	Sensor de presión de sobrealimentación - Renault Midlum / Premium - VW Constellation, Worker.	
0 281 002 593	Sensor de presión de sobrealimentación - Nissan Frontier / X Terra - Renault Clio / Kangoo / Logan / Megane / Scenic.	
0 281 002 656	Medidor de masa de aire - M. Benz Sprinter / Vito / Viano.	
0 281 002 667	Sensor de árbol de levas - Chevrolet S10 / Blazer - Fiat Ducato - Iveco Daily.	
0 281 002 717	Sensor de cigüeñal (RPM) - Nissan Frontier / X Terra - Opel Astra.	







PERIFÉRICOS







Código	Aplicación	
0 281 002 757	Medidor de masa de aire - Audi A3 / A4 - Seat Ibiza / Leon / Toledo - VW Bora, Newbeetle, Sharan.	
0 281 002 764	Medidor de masa de aire - A. Romeo Spider - Fiat Ducato.	
0 281 002 792	Medidor de masa de aire - A. Romeo 147/ GT - Fiat Bravo / Stilo / Idea / Strada.	
0 281 002 808	Sensor de cigüeñal (RPM) - Massey Ferguson motor Sisu , Cosechadora.	
0 281 002 818	Sensor de cigüeñal (RPM) - Volvo camiones con motor MWM.	
0 281 002 819	Sensor de cigüeñal (RPM) - Volvo camiones con motor MWM.	







Código	Aplicación	
0 281 002 845	Sensor de presión de temperatura - Fiat Ducato / Qubo - Iveco Daily.	
0 281 002 956	Medidor de masa de aire - Audi A2 / A3 / A4 / A6 Q5 / TT - Seat Cordoba / Ibiza / Leon - VW Passat, Sharan, Amarok.	
0 281 002 980	Medidor de masa de aire - A. Romeo 147 / Mito - Fiat Bravo / Punto / Stilo / Strada.	
0 281 002 996	Sensor de presión de sobrealimentación - Nissan Tiida 1.5 DCI - Renault Megane III Coupe 1.4 16V.	
0 281 006 282	Sensor de presión de temperatura - M. Benz Atego / Axor.	







CATALOGO DE **FILTROS (ACEITE, AIRE, COMBUSTIBLE Y HABITACULO)**















		 Cil.  CC			Filtro de aceite 	Filtro de aire 	Filtro de gasolina 		
Marca	Modelo	Motor	Año	Num. Corto	10 Dígitos	Num. Corto	10 Dígitos	Num. Corto	10 Dígitos
Acura	ILX	4 Cil, 2.0L	2013-2015	72273WS	F00E164931	84153WS	0986MF4153		
Acura	ILX	4 Cil, 2.4L	2016-2020	72273WS	F00E164931				
Acura	MDX	6 Cil, 3.5L	2005-2006	72273WS	F00E164931	84196WS	0986MF4196		
Acura	MDX	6 Cil, 3.7L	2007-2013	72273WS	F00E164931	84059WS	0986MF4059		
Acura	MDX	6 Cil, 3.5L	2014-2020	72273WS	F00E164931				
Acura	RDX	4 Cil, 2.3L	2007-2012	72273WS	F00E164931				
Acura	RDX	6 Cil, 3.5L	2013-2018	72273WS	F00E164931				
Acura	RL	6 Cil, 3.5L	2005-2008	72273WS	F00E164931	84253WS	0986MF4253		
Acura	RL	6 Cil, 3.7L	2009-2011	72273WS	F00E164931				
Acura	RLX	6 Cil, 3.5L	2014-2015	72273WS	F00E164931				
Acura	TL	6 Cil, 3.2L	2005-2008	72273WS	F00E164931	84253WS	0986MF4253		
Acura	TL	6 Cil, 3.5L	2009-2013	72273WS	F00E164931	84165WS	0986MF4165		
Acura	TL	6 Cil, 3.7L	2011-2013	72273WS	F00E164931	84165WS	0986MF4165		
Acura	TLX	4 Cil, 2.4L	2015-2019	72273WS	F00E164931	84168WS	0986MF4168		
Acura	TLX	6 Cil, 3.5L	2015-2020	72273WS	F00E164931	84168WS	0986MF4168		
Acura	TSX	4 Cil, 2.4L	2009-2013	72273WS	F00E164931				
Acura	TSX	6 Cil, 3.5L	2011-2013	72273WS	F00E164931	84165WS	0986MF4165		
Acura	ZDX	6 Cil, 3.7L	2010-2011	72273WS	F00E164931	84059WS	0986MF4059		
Alfa Romeo	Spider	6 Cil, 3.2L	2007-2008	80009WS	0986MF0009				
Alfa Romeo	Stelvio	4 Cil, 2.0L	2017-2020	80013WS	0986MF0013				
Audi	A1	4 Cil, 1.4L	2011-2018	80051WS	0986MF0051	84143WS	0986MF4143		
Audi	A3	4 Cil, 1.8L	1998-2004	80044WS / 80019WS*	0986MF0044 / 0986MF0019*	5893WS	0986MF4602	77215WS	0986MF2318
Audi	A3	4 Cil, 1.4L	2010-2012	80051WS	0986MF0051	84224WS	0986MF4224		
Audi	A3	4 Cil, 2.0L	2005	80000WS	0986MF0000				
Audi	A3	4 Cil, 2.0L	2005-2008			84222WS	0986MF4222		
Audi	A3	4 Cil, 1.8L	2010-2013	80014WS	0986MF0014				
Audi	A3	4 Cil, 2.0L	2010-2013	80014WS	0986MF0014	84096WS	0986MF4096		
Audi	A3	4 Cil, 1.8L	2013-2016	80049WS	0986MF0049				
Audi	A3	4 Cil, 2.0L	2017	80049WS	0986MF0049	84151WS	0986MF4151		
Audi	A3	4 Cil, 1.4L	2013-2018	80051WS	0986MF0051	84151WS	0986MF4151		
Audi	A3	4 Cil, 2.0L	2017-2020			84151WS	0986MF4151		







											
Marca	Modelo	Motor	Año	Num. Corto	10 Dígitos	Num. Corto	10 Dígitos	Num. Corto	10 Dígitos		
Audi	A3 Quattro	4 Cil, 2.0L	2005	80000WS	0986MF0000						
Audi	A3 Quattro	4 Cil, 2.0L	2006-2007	80000WS	0986MF0000	84222WS	0986MF4222				
Audi	A3 Quattro	4 Cil, 2.0L	2006-2008	80000WS	0986MF0000						
Audi	A3 Quattro	4 Cil, 2.0L	2008	80014WS	0986MF0014	84222WS	0986MF4222				
Audi	A3 Quattro	4 Cil, 2.0L	2011	80014WS	0986MF0014	84096WS	0986MF4096				
Audi	A4	4 Cil, 1.8L	1997-1999	80044WS / 80019WS*	0986MF0044 / 0986MF0019*	84265WS	0986MF4265	77131WS	0986MF2030		
Audi	A4	4 Cil, 1.8L	2003-2004			84170WS	0986MF4170				
Audi	A4	4 Cil, 1.8L	2005			84234WS	0986MF4234				
Audi	A4	6 Cil, 2.8L	1997			84265WS	0986MF4265	77131WS	0986MF2030		
Audi	A4	4 Cil, 1.8L	2000			84265WS	0986MF4265				
Audi	A4	4 Cil, 1.8L	2001	80044WS / 80019WS*	0986MF0044 / 0986MF0019*	84265WS	0986MF4265	77131WS	0986MF2030		
Audi	A4	4 Cil, 2.0L	2006			84170WS	0986MF4170				
Audi	A4	6 Cil, 3.2L	2005-2007			84170WS	0986MF4170				
Audi	A4	4 Cil, 2.0L	2007-2008	80000WS	0986MF0000	84170WS	0986MF4170				
Audi	A4	4 Cil, 1.8L	2014-2016	80044WS / 80019WS*	0986MF0044 / 0986MF0019*						
Audi	A4	4 Cil, 2.0L	2014-2016	80014WS	0986MF0014						
Audi	A4	4 Cil, 2.0L	2017-2021	80014WS	0986MF0014						
Audi	A4 Quattro	6 Cil, 3.2L	2009			84170WS	0986MF4170	82425WS	0986MF2425		
Audi	A4 Quattro	6 Cil, 3.2L	2010-2011			84223WS	0986MF4223	82425WS	0986MF2425		
Audi	A4 Quattro	4 Cil, 2.0L	2010-2021	80014WS	0986MF0014						
Audi	A4 Quattro	6 Cil, 2.8L	1997	80012WS	0986MF0012	84265WS	0986MF4265	77131WS	0986MF2030		
Audi	A4 Quattro	6 Cil, 2.8L	1998			84265WS	0986MF4265				
Audi	A4 Quattro	4 Cil, 1.8L	1999	80044WS / 80019WS*	0986MF0044 / 0986MF0019*	84265WS	0986MF4265	77131WS	0986MF2030		
Audi	A4 Quattro	4 Cil, 1.8L	2000			84265WS	0986MF4265				
Audi	A4 Quattro	4 Cil, 1.8L	2001	80044WS / 80019WS*	0986MF0044 / 0986MF0019*	84265WS	0986MF4265	77131WS	0986MF2030		
Audi	A4 Quattro	6 Cil, 2.8L	2001			84265WS	0986MF4265				
Audi	A4 Quattro	4 Cil, 1.8L	2002-2005	80044WS / 80019WS*	0986MF0044 / 0986MF0019*	84170WS	0986MF4170				
Audi	A4 Quattro	4 Cil, 2.0L	2006			84170WS	0986MF4170				







		 Cil.  CC									
Marca	Modelo	Motor	Año	Num. Corto	10 Dígitos	Num. Corto	10 Dígitos	Num. Corto	10 Dígitos		
Audi	A4 Quattro	4 Cil, 2.0L	2007-2008								
Audi	A4 Quattro	6 Cil, 3.2L	2005-2008								
Audi	A5	4 Cil, 2.0L	2012-2016	80014WS	0986MF0014						
Audi	A5	4 Cil, 1.8L	2012-2016	80014WS	0986MF0014						
Audi	A5	4 Cil, 2.0L	2018	80014WS	0986MF0014						
Audi	A5 Quattro	4 Cil, 2.0L	2011-2013	80014WS	0986MF0014						
Audi	A6	4 Cil, 2.0L	2013-2014	80014WS	0986MF0014						
Audi	A6	6 Cil, 2.8L	1998-1999	80012WS	0986MF0012	84265WS	0986MF4265				
Audi	A6	6 Cil, 2.8L	2000-2001	80012WS	0986MF0012	84265WS	0986MF4265	77131WS	0986MF2030		
Audi	A6	6 Cil, 3.0L	2002-2004			84265WS	0986MF4265	77131WS	0986MF2030		
Audi	A6	6 Cil, 3.0L	2005-2006					77131WS	0986MF2030		
Audi	A6 Quattro	6 Cil, 2.8L	1998-1999	80012WS	0986MF0012	84265WS	0986MF4265				
Audi	A6 Quattro	6 Cil, 2.8L	2000-2001	80012WS	0986MF0012	84265WS	0986MF4265	77131WS	0986MF2030		
Audi	A6 Quattro	6 Cil, 3.0L	2002-2004	80012WS	0986MF0012			77131WS	0986MF2030		
Audi	A6 Quattro	8 Cil, 4.2L	2005			84265WS	0986MF4265	77131WS	0986MF2030		
Audi	A6 Quattro	6 Cil, 3.0L	2005-2006					77131WS	0986MF2030		
Audi	Allroad Quattro	6 Cil, 2.7L	2002-2004	80012WS	0986MF0012	84265WS	0986MF4265				
Audi	Cabriolet	6 Cil, 2.8L	1997-1998	80012WS	0986MF0012	5882WS	0986MF4545				
Audi	Q3	4 Cil, 2.0L	2013-2016	80014WS	0986MF0014	84096WS	0986MF4096				
Audi	Q3	4 Cil, 1.4L	2016-2018	80049WS	0986MF0049	84151WS	0986MF4151				
Audi	Q3 Quattro	4 Cil, 2.0L	2016-2018	80014WS	0986MF0014	84096WS	0986MF4096				
Audi	Q5	4 Cil, 2.0L	2014-2016	80014WS	0986MF0014						
Audi	Q7	8 Cil, 4.2L	2007-2013			84220WS	0986MF4220				
Audi	Q7	6 Cil, 3.0L	2008-2019			84220WS	0986MF4220				
Audi	Q7	6 Cil, 3.6L	2007-2010			84220WS	0986MF4220				
Audi	S6	8 Cil, 4.2L	2001-2004			84265WS	0986MF4265				
Audi	TT	4 Cil, 2.0L	2007-2008	80000WS	0986MF0000	84222WS	0986MF4222				
Audi	TT	4 Cil, 2.0L	2009-2014	80014WS	0986MF0014	84096WS	0986MF4096				
Audi	TT	4 Cil, 1.8L	2011-2016	80014WS	0986MF0014						
Audi	TT	4 Cil, 1.8L	1999	80044WS / 80019WS*	0986MF0044 / 0986MF0019*						
Audi	TT	4 Cil, 1.8L	2000-2002	80044WS / 80019WS*	0986MF0044 / 0986MF0019*	5893WS	0986MF4602				







											
Marca	Modelo	Motor	Año	Num. Corto	10 Dígitos	Num. Corto	10 Dígitos	Num. Corto	10 Dígitos		
Audi	TT	4 Cil, 1.8L	2003-2006	80044WS / 80019WS*	0986MF0044 / 0986MF0019*	5893WS	0986MF4602	77215WS	0986MF2318		
Audi	TT Quattro	4 Cil, 1.8L	2001-2002	80044WS / 80019WS*	0986MF0044 / 0986MF0019*	5893WS	0986MF4602				
Audi	TT Quattro	4 Cil, 1.8L	2003-2006	80044WS / 80019WS*	0986MF0044 / 0986MF0019*	5893WS	0986MF4602	77215WS	0986MF2318		
Audi	TT Quattro	6 Cil, 3.2L	2007-2009			84223WS	0986MF4223	82425WS	0986MF2425		
Audi	TT RS Quattro	5 Cil, 2.5L	2011-2014			84223WS	0986MF4223				
Audi	TTS Quattro	4 Cil, 2.0L	2010-2014	80000WS	0986MF0000	84096WS	0986MF4096				
BMW	130i	6 Cil, 3.0L	2006-2010			84178WS	0986MF4178				
BMW	320i	6 Cil, 2.2L	2001-2005			84025WS	0986MF4025				
BMW	323i	6 Cil, 2.5L	1997-2001			84025WS	0986MF4025				
BMW	325Ci	6 Cil, 2.5L	2001-2006			84025WS	0986MF4025				
BMW	325i	6 Cil, 2.5L	1995-1997			84025WS	0986MF4025	77131WS	0986MF2030		
BMW	325i	6 Cil, 2.5L	2001-2005			84025WS	0986MF4025				
BMW	325i	6 Cil, 3.0L	2011-2013			84178WS	0986MF4178				
BMW	328i	6 Cil, 2.8L	1996-2000			84025WS	0986MF4025				
BMW	330Ci	6 Cil, 3.0L	2001-2006			84025WS	0986MF4025				
BMW	330i	6 Cil, 3.0L	2001-2005			84025WS	0986MF4025				
BMW	525i	6 Cil, 2.5L	2001-2003			84025WS	0986MF4025				
BMW	528i	6 Cil, 2.8L	1996-2000			84025WS	0986MF4025				
BMW	530i	6 Cil, 3.0L	2001-2003			84025WS	0986MF4025				
BMW	540i	8 Cil, 4.4L	1997-2003			84265WS	0986MF4265				
BMW	740iL	8 Cil, 4.4L	1998-2001			84265WS	0986MF4265				
BMW	745i	8 Cil, 4.4L	2002-2005			84181WS	0986MF4181				
BMW	745Li	8 Cil, 4.4L	2003-2005			84181WS	0986MF4181				
BMW	750i	8 Cil, 4.8L	2006-2009			84181WS	0986MF4181				
BMW	750Li	8 Cil, 4.8L	2006-2009			84181WS	0986MF4181				
BMW	760Li	12 Cil, 6.0L	2003-2009			84181WS	0986MF4181				
BMW	M3	6 Cil, 3.0L	1995			84025WS	0986MF4025				
BMW	M3	6 Cil, 3.2L	1996-1999			84025WS	0986MF4025				
BMW	M3	6 Cil, 3.2L	2001-2006			84025WS	0986MF4025				
BMW	X5	8 Cil, 4.4L	2000-2006			84265WS	0986MF4265				







		 Cil.  CC				Filtro de aceite 		Filtro de aire 		Filtro de gasolina 	
Marca	Modelo	Motor	Año	Num. Corto	10 Dígitos	Num. Corto	10 Dígitos	Num. Corto	10 Dígitos	Num. Corto	10 Dígitos
BMW	Z3	6 Cil, 3.2L	1998-2002					84025WS	0986MF4025		
BMW	Z3	6 Cil, 2.8L	1997-2000					84025WS	0986MF4025		
BMW	Z3	6 Cil, 3.0L	2001-2002					84025WS	0986MF4025		
Buick	Century	6 Cil, 2.8L	1983-1986	80043WS	0986MF0043	5833WS	0986MF4005				
Buick	Century	6 Cil, 2.8L	1986-1988	80043WS	0986MF0043	5833WS	0986MF4005	77125WS		0986MF2019	
Buick	Century	6 Cil, 3.1L	1989-1993	80039WS	0986MF0039	5833WS	0986MF4005	77125WS		0986MF2019	
Buick	Century	6 Cil, 3.1L	1994-1996	80039WS	0986MF0039	5838WS	0986MF4302				
Buick	Enclave	6 Cil, 3.6L	2010-2013	80013WS	0986MF0013	84044WS	0986MF4044				
Buick	Enclave	6 Cil, 3.6L	2014-2017			84044WS	0986MF4044				
Buick	Enclave	6 Cil, 3.6L	2018-2021	80013WS	0986MF0013						
Buick	Encore	4 Cil, 1.4L	2014-2019	80004WS	0986MF0004	84055WS	0986MF4055				
Buick	Envision	4 Cil, 2.0L	2016-2020	80013WS	0986MF0013						
Buick	Regal	6 Cil, 3.8L	1994-1996	80039WS	0986MF0039						
Buick	Regal	4 Cil, 2.0L	2014-2017	80013WS	0986MF0013						
Buick	Verano	4 Cil, 2.0L	2013-2016			84238WS	0986MF4238				
Buick	Verano	4 Cil, 2.4L	2014-2016	80021WS	0986MF0021	84258WS	0986MF4258				
Cadillac	ATS	4 Cil, 2.0L	2013-2019	80013WS	0986MF0013						
Cadillac	BLS	4 Cil, 2.0L	2007-2008	80021WS	0986MF0021						
Cadillac	Catera	6 Cil, 3.0L	1997-2001	80039WS	0986MF0039			77130WS		0986MF2026	
Cadillac	CTS	6 Cil, 3.6L	2008-2016	80009WS	0986MF0009						
Cadillac	CTS	8 Cil, 6.2L	2012-2019	80013WS	0986MF0013						
Cadillac	CTS	6 Cil, 3.2L	2003					77130WS		0986MF2026	
Cadillac	CTS	6 Cil, 3.6L	2004-2007	80009WS	0986MF0009			77130WS		0986MF2026	
Cadillac	CTS	6 Cil, 3.0L	2012	80009WS	0986MF0009						
Cadillac	CTS	4 Cil, 2.0L	2015-2019	80013WS	0986MF0013						
Cadillac	DeVille	8 Cil, 4.6L	1994-1999	80030WS	0986MF0030	5920WS	0986MF4754				
Cadillac	DeVille	8 Cil, 4.9L	1991-1995	80030WS	0986MF0030	5920WS	0986MF4754				
Cadillac	DeVille	8 Cil, 4.6L	2000-2004	80030WS	0986MF0030	5889WS	0986MF4597				
Cadillac	Eldorado	8 Cil, 4.6L	1994-1997	80030WS	0986MF0030	5920WS	0986MF4754				
Cadillac	Escalade	8 Cil, 6.2L	2007-2016	80013WS	0986MF0013	5921WS	0986MF4755				
Cadillac	Escalade	8 Cil, 6.0L	2002-2006	80030WS	0986MF0030	5921WS	0986MF4755	77125WS		0986MF2019	
Cadillac	Escalade ESV	8 Cil, 6.0L	2003-2006	80030WS	0986MF0030	5921WS	0986MF4755	77125WS		0986MF2019	







											
Marca	Modelo	Motor	Año	Num. Corto	10 Dígitos	Num. Corto	10 Dígitos	Num. Corto	10 Dígitos		
Cadillac	Escalade ESV	8 Cil, 6.2L	2007-2008	80013WS	0986MF0013	5921WS	0986MF4755				
Cadillac	Escalade ESV	8 Cil, 6.2L	2013-2015	80013WS	0986MF0013	5921WS	0986MF4755				
Cadillac	Escalade ESV	8 Cil, 6.2L	2015-2020			5921WS	0986MF4755				
Cadillac	Escalade EXT	8 Cil, 6.0L	2002-2006	80030WS	0986MF0030	5921WS	0986MF4755	77125WS	0986MF2019		
Cadillac	Escalade EXT	8 Cil, 6.2L	2007-2013	80013WS	0986MF0013	5921WS	0986MF4755				
Cadillac	Seville	8 Cil, 4.6L	1994	80037WS	0986MF0037	5920WS	0986MF4754				
Cadillac	Seville	8 Cil, 4.6L	1995-1997	80030WS	0986MF0030	5920WS	0986MF4754				
Cadillac	Seville	8 Cil, 4.6L	1998-2004	80030WS	0986MF0030	5889WS	0986MF4597				
Cadillac	SRX	6 Cil, 3.6L	2004-2006	80009WS	0986MF0009						
Cadillac	SRX	8 Cil, 4.6L	2004-2006	80037WS	0986MF0037						
Cadillac	SRX	6 Cil, 3.0L	2010-2011	80013WS	0986MF0013						
Cadillac	STS	6 Cil, 3.6L	2006-2010	80009WS	0986MF0009						
Cadillac	STS	8 Cil, 4.6L	2005-2010	80037WS	0986MF0037						
Cadillac	XLR	8 Cil, 4.6L	2004-2006	80037WS	0986MF0037	5889WS	0986MF4597				
Chevrolet	Astra	4 Cil, 1.8L	2000-2001	80023WS	0986MF0023	84252WS	0986MF4252	77208WS	0986MF2273		
Chevrolet	Astra	4 Cil, 1.8L	2002-2003	80021WS	0986MF0021	84252WS	0986MF4252	77208WS	0986MF2273		
Chevrolet	Astra	4 Cil, 2.2L	2001-2003	80021WS	0986MF0021	5937WS	0986MF4935	77208WS	0986MF2273		
Chevrolet	Astra	4 Cil, 2.4L	2004-2006	80039WS	0986MF0039	5937WS	0986MF4935	77208WS	0986MF2273		
Chevrolet	Astra	4 Cil, 1.8L	2006-2008	80004WS	0986MF0004	84252WS	0986MF4252	77208WS	0986MF2273		
Chevrolet	Astra	4 Cil, 2.0L	2004-2008	80039WS	0986MF0039	5937WS	0986MF4935	77208WS	0986MF2273		
Chevrolet	Avalanche	8 Cil, 5.3L	2007-2013	80013WS	0986MF0013	5921WS	0986MF4755	77125WS	0986MF2019		
Chevrolet	Avalanche 1500	8 Cil, 5.3L	2002-2005	80013WS	0986MF0013	5921WS	0986MF4755	77125WS	0986MF2019		
Chevrolet	Avalanche 1500	8 Cil, 5.3L	2006	80030WS	0986MF0030	5921WS	0986MF4755	77173WS	0986MF2137		
Chevrolet	Aveo	4 Cil, 1.6L	2008-2018	80039WS	0986MF0039	84228WS	0986MF4228	82899WS	0986MF2899		
Chevrolet	Aveo	4 Cil, 1.5L	2018-2021	72276WS	F00E164934	84211WS	0986MF4211				
Chevrolet	Beat	4 Cil, 1.2L	2018-2021	72276WS	F00E164934	84267WS	0986MF4267				
Chevrolet	Blazer	6 Cil, 4.3L	1995-2001	80043WS	0986MF0043	5864WS	0986MF4421	77173WS	0986MF2137		
Chevrolet	Blazer	6 Cil, 4.2L	2002	80037WS	0986MF0037	5864WS	0986MF4421	77173WS	0986MF2137		
Chevrolet	C10	8 Cil, 5.7L	1976-1980	80018WS	0986MF0018						
Chevrolet	C10	6 Cil, 4.1L	1976-1981	80041WS	0986MF0041						
Chevrolet	C10	6 Cil, 4.8L	1975-1981	80041WS	0986MF0041						
Chevrolet	C10	8 Cil, 5.7L	1981	80030WS	0986MF0030						







											
Marca	Modelo	Motor	Año	Num. Corto	10 Dígitos	Num. Corto	10 Dígitos	Num. Corto	10 Dígitos		
Chevrolet	C1500	6 Cil, 4.1L	1989-1998					77125WS	0986MF2019		
Chevrolet	C20	8 Cil, 5.7L	1986-1987	80041WS	0986MF0041						
Chevrolet	C2500	8 Cil, 5.7L	1988-1994	80018WS	0986MF0018	84237WS	0986MF4237	77125WS	0986MF2019		
Chevrolet	C30	8 Cil, 5.7L	1976-1980	80018WS	0986MF0018						
Chevrolet	C30	6 Cil, 4.1L	1976-1982	80041WS	0986MF0041						
Chevrolet	C30	6 Cil, 4.8L	1975-1982	80041WS	0986MF0041						
Chevrolet	C35	8 Cil, 5.7L	1983-1995			84237WS	0986MF4237				
Chevrolet	Camaro	6 Cil, 3.8L	1996-1997	80030WS	0986MF0030	5864WS	0986MF4421	77130WS	0986MF2026		
Chevrolet	Camaro	8 Cil, 5.7L	1995-1996	80041WS	0986MF0041	5864WS	0986MF4421	77130WS	0986MF2026		
Chevrolet	Camaro	6 Cil, 3.8L	1998	80030WS	0986MF0030	84261WS	0986MF4261	77130WS	0986MF2026		
Chevrolet	Camaro	8 Cil, 5.7L	1999-2002	80030WS	0986MF0030	84261WS	0986MF4261	77130WS	0986MF2026		
Chevrolet	Camaro	6 Cil, 3.6L	2010			84163WS	0986MF4163				
Chevrolet	Camaro	6 Cil, 3.6L	2011	80009WS	0986MF0009	84163WS	0986MF4163				
Chevrolet	Camaro	6 Cil, 3.6L	2012-2015			84163WS	0986MF4163				
Chevrolet	Camaro	8 Cil, 6.2L	2010-2015	80013WS	0986MF0013	84163WS	0986MF4163				
Chevrolet	Camaro	8 Cil, 6.2L	2014-2015	80013WS	0986MF0013	84163WS	0986MF4163				
Chevrolet	Camaro	4 Cil, 2.0L	2016-2018	80013WS	0986MF0013						
Chevrolet	Camaro	8 Cil, 6.2L	2017-2021	80013WS	0986MF0013						
Chevrolet	Caprice	8 Cil, 5.7L	1979-1982	80030WS	0986MF0030	84237WS	0986MF4237				
Chevrolet	Captiva Sport	4 Cil, 2.4L	2008-2010	80013WS	0986MF0013	84041WS	0986MF4041				
Chevrolet	Captiva Sport	6 Cil, 3.6L	2008-2010	80013WS	0986MF0013	84041WS	0986MF4041				
Chevrolet	Captiva Sport	4 Cil, 2.4L	2011-2015	80021WS	0986MF0021	84041WS	0986MF4041				
Chevrolet	Captiva Sport	6 Cil, 3.0L	2011-2015	80013WS	0986MF0013	84041WS	0986MF4041				
Chevrolet	Cavalier	6 Cil, 2.8L	1990-1994	80039WS	0986MF0039	5833WS	0986MF4005	77125WS	0986MF2019		
Chevrolet	Cavalier	4 Cil, 2.2L	1995-2004	80039WS	0986MF0039	5935WS	0986MF4916	77130WS	0986MF2026		
Chevrolet	Cavalier	4 Cil, 2.4L	1995-1996	80030WS	0986MF0030	5935WS	0986MF4916	77130WS	0986MF2026		
Chevrolet	Cavalier	4 Cil, 1.5L	2018-2021	72276WS	F00E164934						
Chevrolet	Celebrity	6 Cil, 2.8L	1982-1989	80043WS	0986MF0043	5833WS	0986MF4005	77150WS	0986MF2057		
Chevrolet	Chevy	4 Cil, 1.4L	1994-2002	80039WS	0986MF0039	5878WS	0986MF4496	77208WS	0986MF2273		
Chevrolet	Chevy	4 Cil, 1.6L	1996-2012	80039WS	0986MF0039	5878WS	0986MF4496	77208WS	0986MF2273		
Chevrolet	Chevy Monza	4 Cil, 1.6L	1997-2003	80039WS	0986MF0039	5878WS	0986MF4496	77208WS	0986MF2273		
Chevrolet	Cheyenne	8 Cil, 5.3L	2007-2020	80013WS	0986MF0013	5921WS	0986MF4755	77125WS	0986MF2019		







											
Marca	Modelo	Motor	Año	Num. Corto	10 Dígitos	Num. Corto	10 Dígitos	Num. Corto	10 Dígitos		
Chevrolet	Cheyenne	8 Cil, 6.2L	2014-2016			5921WS	0986MF4755				
Chevrolet	Citation	6 Cil, 2.8L	1982-1986	80043WS	0986MF0043	5833WS	0986MF4005				
Chevrolet	Colorado	5 Cil, 3.5L	2004-2006	80037WS	0986MF0037	84244WS	0986MF4244				
Chevrolet	Colorado	5 Cil, 3.7L	2007	80037WS	0986MF0037	84244WS	0986MF4244				
Chevrolet	Colorado	4 Cil, 2.9L	2011-2012	80030WS	0986MF0030	84186WS	0986MF4186				
Chevrolet	Colorado	5 Cil, 3.7L	2008-2012	80037WS	0986MF0037	84186WS	0986MF4186				
Chevrolet	Colorado	6 Cil, 3.6L	2013-2016	80009WS	0986MF0009	84205WS	0986MF4205				
Chevrolet	Colorado	4 Cil, 2.5L	2016-2021	80013WS	0986MF0013	84205WS	0986MF4205				
Chevrolet	Colorado	6 Cil, 3.6L	2017-2021	80004WS	0986MF0004	84205WS	0986MF4205				
Chevrolet	Corsa	4 Cil, 1.8L	2003-2008	80039WS	0986MF0039	5900WS	0986MF4626	77208WS	0986MF2273		
Chevrolet	Corsa	4 Cil, 1.4L	2002	80039WS	0986MF0039	5900WS	0986MF4626	77208WS	0986MF2273		
Chevrolet	Corvette	8 Cil, 5.7L	1991-1996	80043WS	0986MF0043			77125WS	0986MF2019		
Chevrolet	Corvette	8 Cil, 6.2L	2008-2019	80013WS	0986MF0013						
Chevrolet	Corvette	8 Cil, 5.7L	1999-2003	80030WS	0986MF0030	84261WS	0986MF4261				
Chevrolet	Corvette	8 Cil, 5.7L	1997-2004			84261WS	0986MF4261				
Chevrolet	Corvette	8 Cil, 6.0L	2005-2006	80030WS	0986MF0030			77130WS	0986MF2026		
Chevrolet	Cruze	4 Cil, 1.8L	2010-2016	80004WS	0986MF0004	84238WS	0986MF4238				
Chevrolet	Cruze	4 Cil, 1.4L	2014-2015	80004WS	0986MF0004	84207WS	0986MF4207				
Chevrolet	Cruze	4 Cil, 1.4L	2017-2019	80013WS	0986MF0013	84207WS	0986MF4207				
Chevrolet	Equinox	6 Cil, 3.4L	2005-2008	80039WS	0986MF0039	84195WS	0986MF4195				
Chevrolet	Equinox	4 Cil, 2.4L	2016-2017	80021WS	0986MF0021	84045WS	0986MF4045				
Chevrolet	Equinox	4 Cil, 1.5L	2018-2021	80013WS	0986MF0013						
Chevrolet	Express 1500	6 Cil, 4.3L	1998-2000	80043WS	0986MF0043	84261WS	0986MF4261				
Chevrolet	Express 1500	6 Cil, 4.3L	2002	80043WS	0986MF0043	84063WS	0986MF4063				
Chevrolet	Express 1500	8 Cil, 5.3L	2003-2008	80030WS	0986MF0030	84063WS	0986MF4063				
Chevrolet	Express 1500	8 Cil, 5.7L	1998-2002	80018WS	0986MF0018	84063WS	0986MF4063				
Chevrolet	Express 1500	6 Cil, 4.3L	2004-2008	80039WS	0986MF0039	84063WS	0986MF4063	77125WS	0986MF2019		
Chevrolet	Express 2500	8 Cil, 5.7L	1999	80018WS	0986MF0018						
Chevrolet	Express 3500	8 Cil, 5.7L	1998-2002	80018WS	0986MF0018	84063WS	0986MF4063				
Chevrolet	Express 3500	8 Cil, 4.8L	2004	80013WS	0986MF0013	84063WS	0986MF4063	77125WS	0986MF2019		
Chevrolet	Express 3500	8 Cil, 6.0L	2004	80030WS	0986MF0030	84063WS	0986MF4063	77125WS	0986MF2019		
Chevrolet	Express 3500	8 Cil, 5.3L	2003-2006	80030WS	0986MF0030	84063WS	0986MF4063	77125WS	0986MF2019		







		 Cil.  CC				Filtro de aceite 		Filtro de aire 		Filtro de gasolina 	
Marca	Modelo	Motor	Año	Num. Corto	10 Dígitos	Num. Corto	10 Dígitos	Num. Corto	10 Dígitos	Num. Corto	10 Dígitos
Chevrolet	Express 3500	8 Cil, 5.3L	2007-2008	80013WS	0986MF0013			84063WS	0986MF4063	77125WS	0986MF2019
Chevrolet	Express Cargo	8 Cil, 5.3L	2009	80013WS	0986MF0013						
Chevrolet	Express Cargo	6 Cil, 4.3L	2009-2014	80039WS	0986MF0039						
Chevrolet	Express Cargo	8 Cil, 6.0L	2010-2016	80013WS	0986MF0013					77130WS	0986MF2026
Chevrolet	Express Cargo	8 Cil, 6.0L	2017	80013WS	0986MF0013						
Chevrolet	Express Pasajeros	8 Cil, 6.0L	2009	80013WS	0986MF0013					77130WS	0986MF2026
Chevrolet	Express Pasajeros	8 Cil, 5.3L	2009-2015	80013WS	0986MF0013						
Chevrolet	Express Pasajeros	8 Cil, 6.0L	2010-2016	80013WS	0986MF0013					77130WS	0986MF2026
Chevrolet	Express Pasajeros	8 Cil, 6.0L	2018-2020	80013WS	0986MF0013						
Chevrolet	G20	6 Cil, 4.3L	1995	80043WS	0986MF0043					77125WS	0986MF2019
Chevrolet	G30	6 Cil, 4.3L	2001-2002					84261WS	0986MF4261		
Chevrolet	Impala	6 Cil, 3.8L	2000-2003	80039WS	0986MF0039					77130WS	0986MF2026
Chevrolet	Lumina Van	6 Cil, 3.8L	1995-1996	80039WS	0986MF0039			5935WS	0986MF4916	77130WS	0986MF2026
Chevrolet	LUV	4 Cil, 2.3L	1997	72273WS	F00E164931			5906WS	0986MF4681	77125WS	0986MF2019
Chevrolet	LUV	4 Cil, 2.2L	1999-2004	72273WS	F00E164931			5865WS	0986MF4427		
Chevrolet	LUV	4 Cil, 2.2L	2005	72273WS	F00E164931			5865WS	0986MF4427		
Chevrolet	Malibu	6 Cil, 3.1L	1997-2003	80039WS	0986MF0039			5832WS	0986MF4221	77130WS	0986MF2026
Chevrolet	Malibu	4 Cil, 2.4L	2009-2012	80021WS	0986MF0021			84195WS	0986MF4195		
Chevrolet	Malibu	6 Cil, 4.1L	1975-1981							77150WS	0986MF2057
Chevrolet	Malibu	8 Cil, 5.7L	1975-1981	80041WS	0986MF0041					77150WS	0986MF2057
Chevrolet	Malibu	4 Cil, 2.4L	1997-1999	80030WS	0986MF0030			5832WS	0986MF4221	77130WS	0986MF2026
Chevrolet	Malibu	4 Cil, 2.2L	2004-2005	80021WS	0986MF0021			5889WS	0986MF4597		
Chevrolet	Malibu	6 Cil, 3.5L	2006	80039WS	0986MF0039			5889WS	0986MF4597		
Chevrolet	Malibu	6 Cil, 3.5L	2007-2008	80037WS	0986MF0037						
Chevrolet	Malibu	6 Cil, 3.6L	2009-2012	80013WS	0986MF0013			84195WS	0986MF4195		
Chevrolet	Malibu	4 Cil, 2.5L	2013-2015	80013WS	0986MF0013						
Chevrolet	Malibu	4 Cil, 1.5L	2016-2019	80013WS	0986MF0013						
Chevrolet	Malibu	4 Cil, 2.0L	2013-2019	80013WS	0986MF0013						
Chevrolet	Matiz	4 Cil, 1.0L	2011-2015	80011WS	0986MF0011					82899WS	0986MF2899
Chevrolet	Meriva	4 Cil, 1.8L	2004-2008	80039WS	0986MF0039			5900WS	0986MF4626	77208WS	0986MF2273
Chevrolet	Nova	6 Cil, 4.1L	1975-1978	80041WS	0986MF0041						
Chevrolet	Nova	8 Cil, 5.7L	1977-1978	80041WS	0986MF0041						







											
Marca	Modelo	Motor	Año	Num. Corto	10 Dígitos	Num. Corto	10 Dígitos	Num. Corto	10 Dígitos		
Chevrolet	Optra	4 Cil, 2.0L	2006-2010	80039WS	0986MF0039	84048WS	0986MF4048				
Chevrolet	P30	8 Cil, 5.7L	1991-1994	80013WS	0986MF0013	84237WS	0986MF4237				
Chevrolet	P30	8 Cil, 5.7L	1996-1998	80040WS	0986MF0040						
Chevrolet	S10	6 Cil, 3.1L	1991-1993	80039WS	0986MF0039			77125WS	0986MF2019		
Chevrolet	S10	4 Cil, 2.2L	1995-2002	80039WS	0986MF0039	5864WS	0986MF4421	77125WS	0986MF2019		
Chevrolet	S10	4 Cil, 2.2L	2003	80039WS	0986MF0039	5864WS	0986MF4421	77173WS	0986MF2137		
Chevrolet	S10	4 Cil, 2.5L	2016-2017			84205WS	0986MF4205	77208WS	0986MF2273		
Chevrolet	S10 Blazer	6 Cil, 3.1L	1991-1994	80039WS	0986MF0039			77125WS	0986MF2019		
Chevrolet	Silverado	8 Cil, 5.7L	1995-1998	80041WS	0986MF0041	84237WS	0986MF4237				
Chevrolet	Silverado	8 Cil, 5.7L	1999	80041WS	0986MF0041	84242WS	0986MF4242				
Chevrolet	Silverado 1500	6 Cil, 4.3L	2002-2016	80039WS	0986MF0039	5921WS	0986MF4755				
Chevrolet	Silverado 1500	6 Cil, 4.3L	2017-2020			5921WS	0986MF4755				
Chevrolet	Silverado 2500	8 Cil, 5.3L	2007-2016	80013WS	0986MF0013	5921WS	0986MF4755	77173WS	0986MF2137		
Chevrolet	Silverado 2500	8 Cil, 5.7L	2000-2002			84242WS	0986MF4242				
Chevrolet	Silverado 2500	8 Cil, 5.3L	2001-2003	80030WS	0986MF0030	5921WS	0986MF4755	77173WS	0986MF2137		
Chevrolet	Silverado 2500	8 Cil, 4.8L	2007-2009	80013WS	0986MF0013						
Chevrolet	Silverado 2500	6 Cil, 4.3L	2017			5921WS	0986MF4755				
Chevrolet	Silverado 2500	8 Cil, 5.3L	2017-2018			5921WS	0986MF4755	77173WS	0986MF2137		
Chevrolet	Silverado 3500	8 Cil, 6.0L	2008-2017	80013WS	0986MF0013	5921WS	0986MF4755				
Chevrolet	Silverado 3500	8 Cil, 5.7L	2001-2007	80018WS	0986MF0018	5921WS	0986MF4755				
Chevrolet	Sonic	4 Cil, 1.4L	2014-2016	80004WS	0986MF0004	84051WS	0986MF4051	82899WS	0986MF2899		
Chevrolet	Sonic	4 Cil, 1.6L	2012-2017	80004WS	0986MF0004	84051WS	0986MF4051	82899WS	0986MF2899		
Chevrolet	Sonora	8 Cil, 5.3L	2003-2006	80018WS	0986MF0018	5921WS	0986MF4755	77125WS	0986MF2019		
Chevrolet	Spark	4 Cil, 1.2L	2011-2015	72276WS	F00E164934	84267WS	0986MF4267				
Chevrolet	Spark	4 Cil, 1.4L	2016-2021	80013WS	0986MF0013	84192WS	0986MF4192				
Chevrolet	Spark Classic	4 Cil, 1.2L	2016-2017	72276WS	F00E164934	84267WS	0986MF4267				
Chevrolet	Suburban	8 Cil, 5.7L	1990-1994			84242WS	0986MF4242				
Chevrolet	Suburban	8 Cil, 5.7L	1987			84237WS	0986MF4237				
Chevrolet	Suburban	8 Cil, 5.3L	2010-2016	80013WS	0986MF0013	5921WS	0986MF4755				
Chevrolet	Suburban	8 Cil, 5.3L	2017-2020			5921WS	0986MF4755				
Chevrolet	Suburban 1500	8 Cil, 5.7L	1996-1999			84242WS	0986MF4242				
Chevrolet	Suburban 1500	8 Cil, 5.7L	1995-2002	80037WS	0986MF0037	84242WS	0986MF4242				







		 Cil.  CC				Filtro de aceite 		Filtro de aire 		Filtro de gasolina 	
Marca	Modelo	Motor	Año	Num. Corto	10 Dígitos	Num. Corto	10 Dígitos	Num. Corto	10 Dígitos	Num. Corto	10 Dígitos
Chevrolet	Suburban 1500	8 Cil, 5.3L	2003-2006	80030WS	0986MF0030	5921WS	0986MF4755	77125WS	0986MF2019		
Chevrolet	Suburban 1500	8 Cil, 5.3L	2007-2013	80013WS	0986MF0013	5921WS	0986MF4755				
Chevrolet	Suburban 1500	8 Cil, 6.0L	2010-2013	80013WS	0986MF0013						
Chevrolet	Suburban 2500	8 Cil, 6.0L	2009	80013WS	0986MF0013	5921WS	0986MF4755				
Chevrolet	Tahoe	8 Cil, 5.3L	2007-2016	80013WS	0986MF0013	5921WS	0986MF4755				
Chevrolet	Tahoe	8 Cil, 5.3L	2017-2020			5921WS	0986MF4755				
Chevrolet	Tigra	4 Cil, 1.6L	1999	80039WS	0986MF0039						
Chevrolet	Tornado	4 Cil, 1.8L	2004-2010	80039WS	0986MF0039	5900WS	0986MF4626	77208WS	0986MF2273		
Chevrolet	Tornado	4 Cil, 1.8L	2011-2020	80039WS	0986MF0039	84145WS	0986MF4145	77208WS	0986MF2273		
Chevrolet	Tracker	4 Cil, 2.0L	1999-2008	80028WS	0986MF0028	5818WS	0986MF4069				
Chevrolet	Tracker	4 Cil, 1.6L	1998	80034WS	0986MF0034						
Chevrolet	Trailblazer	6 Cil, 4.2L	2002-2007	80037WS	0986MF0037	5844WS	0986MF4345	77173WS	0986MF2137		
Chevrolet	Traverse	6 Cil, 3.6L	2010-2017	80013WS	0986MF0013	84044WS	0986MF4044				
Chevrolet	Traverse	6 Cil, 3.6L	2018-2021			84044WS	0986MF4044				
Chevrolet	Trax	4 Cil, 1.4L	2014-2015	80004WS	0986MF0004	84055WS	0986MF4055				
Chevrolet	Trax	4 Cil, 1.8L	2013-2020	80004WS	0986MF0004	84055WS	0986MF4055				
Chevrolet	Uplander	6 Cil, 3.5L	2005-2006	80039WS	0986MF0039	5889WS	0986MF4597				
Chevrolet	Uplander	6 Cil, 3.9L	2007-2009	80037WS	0986MF0037	5889WS	0986MF4597				
Chevrolet	Vectra	4 Cil, 2.2L	2003-2005	80021WS	0986MF0021	5870WS	0986MF4461	77208WS	0986MF2273		
Chevrolet	Vectra	6 Cil, 3.2L	2003-2005	80021WS	0986MF0021	5870WS	0986MF4461	77208WS	0986MF2273		
Chevrolet	Vectra	6 Cil, 2.8L	2006-2008	80009WS	0986MF0009	5870WS	0986MF4461	77208WS	0986MF2273		
Chevrolet	Venture	6 Cil, 3.4L	1997-2004	80039WS	0986MF0039	5889WS	0986MF4597				
Chevrolet	Volt	4 Cil, 1.5L	2016-2019	80013WS	0986MF0013						
Chevrolet	Zafira	4 Cil, 1.8L	2002-2006			84252WS	0986MF4252				
Chevrolet	Zafira	4 Cil, 2.2L	2002-2006	80021WS	0986MF0021	5937WS	0986MF4935	77208WS	0986MF2273		
Chrysler	200	4 Cil, 2.4L	2012-2016	80013WS	0986MF0013	5815WS	0986MF4054				
Chrysler	200	6 Cil, 3.6L	2012-2016	80046WS	0986MF0046	84034WS	0986MF4034				
Chrysler	300	6 Cil, 3.5L	2006-2009	80036WS	0986MF0036	5900WS	0986MF4626				
Chrysler	300	8 Cil, 5.7L	2005-2007	80036WS	0986MF0036	5900WS	0986MF4626				
Chrysler	300	8 Cil, 6.1L	2006-2008	80036WS	0986MF0036	5900WS	0986MF4626				
Chrysler	300	8 Cil, 5.7L	2009	80013WS	0986MF0013	5900WS	0986MF4626				
Chrysler	300	6 Cil, 2.7L	2010	80013WS	0986MF0013	5900WS	0986MF4626				







											
Marca	Modelo	Motor	Año	Num. Corto	10 Dígitos	Num. Corto	10 Dígitos	Num. Corto	10 Dígitos		
Chrysler	300	6 Cil, 3.5L	2010	80013WS	0986MF0013	5900WS	0986MF4626				
Chrysler	300	8 Cil, 6.4L	2012-2014	80013WS	0986MF0013						
Chrysler	300	8 Cil, 5.7L	2010-2015	80029WS	0986MF0029	5900WS	0986MF4626				
Chrysler	300	6 Cil, 3.6L	2012-2019	80046WS	0986MF0046						
Chrysler	300	8 Cil, 5.7L	2016-2019	80013WS	0986MF0013	5900WS	0986MF4626				
Chrysler	300M	6 Cil, 3.5L	1999-2004	80036WS	0986MF0036	84089WS	0986MF4089				
Chrysler	Aspen	8 Cil, 5.7L	2007	80029WS	0986MF0029	84035WS	0986MF4035				
Chrysler	Aspen	8 Cil, 5.7L	2008	80036WS	0986MF0036	84035WS	0986MF4035				
Chrysler	Cirrus	6 Cil, 2.5L	1996-2000	80036WS	0986MF0036	5866WS	0986MF4432				
Chrysler	Cirrus	4 Cil, 2.4L	1997-2006	80034WS	0986MF0034	5866WS	0986MF4432				
Chrysler	Cirrus	6 Cil, 2.7L	2002-2006	80036WS	0986MF0036						
Chrysler	Concorde	6 Cil, 3.5L	1993-1997	80036WS	0986MF0036	84134WS	0986MF4134				
Chrysler	Concorde	6 Cil, 3.2L	2001	80036WS	0986MF0036	84089WS	0986MF4089				
Chrysler	Concorde	6 Cil, 3.5L	2002	80036WS	0986MF0036	84089WS	0986MF4089				
Chrysler	Cordoba	8 Cil, 5.9L	1980-1982	80036WS	0986MF0036			82890WS	0986MF2890		
Chrysler	Grand Voyager	6 Cil, 3.8L	1994-1995	80036WS	0986MF0036	84239WS	0986MF4239				
Chrysler	Grand Voyager	6 Cil, 3.8L	1996-2000	80036WS	0986MF0036	84234WS	0986MF4234				
Chrysler	Grand Voyager	6 Cil, 3.3L	1991-1993	80036WS	0986MF0036	84239WS	0986MF4239				
Chrysler	Imperial	6 Cil, 3.3L	1991	80036WS	0986MF0036	84239WS	0986MF4239				
Chrysler	Intrepid	6 Cil, 3.5L	1994-1997	80036WS	0986MF0036	84134WS	0986MF4134				
Chrysler	LeBaron	8 Cil, 5.9L	1978-1979	80036WS	0986MF0036	5839WS	0986MF4305	82890WS	0986MF2890		
Chrysler	LeBaron	8 Cil, 5.9L	1978-1982	80036WS	0986MF0036	5839WS	0986MF4305	82890WS	0986MF2890		
Chrysler	LeBaron	8 Cil, 5.9L	1979-1982	80036WS	0986MF0036	5839WS	0986MF4305	82890WS	0986MF2890		
Chrysler	LeBaron	8 Cil, 5.9L	1980-1982	80036WS	0986MF0036	5839WS	0986MF4305	82890WS	0986MF2890		
Chrysler	LeBaron	4 Cil, 2.2L	1983-1987	80034WS	0986MF0034	84239WS	0986MF4239				
Chrysler	LeBaron	4 Cil, 2.5L	1991-1992	80036WS	0986MF0036	84234WS	0986MF4234				
Chrysler	LeBaron	4 Cil, 2.5L	1993-1995	80034WS	0986MF0034	84234WS	0986MF4234				
Chrysler	LHS	6 Cil, 3.5L	1996-1997	80036WS	0986MF0036	84134WS	0986MF4134				
Chrysler	Neon	4 Cil, 2.0L	1995-1997	80034WS	0986MF0034	84234WS	0986MF4234				
Chrysler	New Yorker	4 Cil, 2.2L	1985-1989	80034WS	0986MF0034						
Chrysler	New Yorker	6 Cil, 3.5L	1994-1995			84134WS	0986MF4134				
Chrysler	New Yorker	4 Cil, 2.5L	1990-1993	80034WS	0986MF0034	84255WS	0986MF4255				







		 									
Marca	Modelo	Motor	Año	Num. Corto	10 Dígitos	Num. Corto	10 Dígitos	Num. Corto	10 Dígitos		
Chrysler	New Yorker	6 Cil, 3.0L	1992-1994								
Chrysler	Pacifica	6 Cil, 3.5L	2004-2006	80036WS	0986MF0036						
Chrysler	Pacifica	6 Cil, 3.8L	2007	80036WS	0986MF0036						
Chrysler	Pacifica	6 Cil, 4.0L	2007-2008	80036WS	0986MF0036						
Chrysler	Pacifica	6 Cil, 3.6L	2017-2021			84182WS	0986MF4182				
Chrysler	Phantom	4 Cil, 2.2L	1988-1989	80034WS	0986MF0034	84239WS	0986MF4239				
Chrysler	Phantom	4 Cil, 2.2L	1992	80034WS	0986MF0034	84255WS	0986MF4255				
Chrysler	Phantom	4 Cil, 2.5L	1990-1994	80034WS	0986MF0034	84255WS	0986MF4255				
Chrysler	PT Cruiser	4 Cil, 2.4L	2001-2008	80034WS	0986MF0034	5918WS	0986MF4747				
Chrysler	Shadow	4 Cil, 2.2L	1989-1990	80034WS	0986MF0034	84239WS	0986MF4239				
Chrysler	Shadow	4 Cil, 2.5L	1989-1994	80034WS	0986MF0034	84234WS	0986MF4234				
Chrysler	Spirit	4 Cil, 2.5L	1990-1995	80034WS	0986MF0034	84255WS	0986MF4255				
Chrysler	Stratus	4 Cil, 2.0L	1995-1997	80034WS	0986MF0034	5866WS	0986MF4432				
Chrysler	Stratus	4 Cil, 2.4L	1995-1997	80034WS	0986MF0034	5866WS	0986MF4432				
Chrysler	Town & Country	6 Cil, 3.8L	1994-1997	80036WS	0986MF0036	84239WS	0986MF4239				
Chrysler	Town & Country	6 Cil, 3.8L	2001-2007	80036WS	0986MF0036	5815WS	0986MF4054				
Chrysler	Town & Country	6 Cil, 3.3L	2010	80034WS	0986MF0034	5815WS	0986MF4054				
Chrysler	Town & Country	6 Cil, 3.8L	2010	80036WS	0986MF0036	5815WS	0986MF4054				
Chrysler	Town & Country	6 Cil, 4.0L	2008-2010	80036WS	0986MF0036	5815WS	0986MF4054				
Chrysler	Town & Country	6 Cil, 3.6L	2011-2013	80003WS	0986MF0003	84182WS	0986MF4182				
Chrysler	Town & Country	6 Cil, 3.6L	2014-2016	80046WS	0986MF0046	84182WS	0986MF4182				
Chrysler	Voyager	6 Cil, 3.3L	1994-1995	80036WS	0986MF0036	84239WS	0986MF4239				
Chrysler	Voyager	6 Cil, 3.3L	2000	80036WS	0986MF0036	84234WS	0986MF4234				
Chrysler	Voyager	6 Cil, 3.3L	1996-1999	80036WS	0986MF0036	84234WS	0986MF4234				
Chrysler	Voyager	6 Cil, 3.3L	2001-2007	80036WS	0986MF0036	5815WS	0986MF4054				
Datsun	Sedan	4 Cil, 1.8L	1984	80020WS	0986MF0020						
Dodge	Atos	4 Cil, 1.0L	2001-2004	80022WS	0986MF0022	5880WS	0986MF4510				
Dodge	Atos	4 Cil, 1.1L	2005-2012	80022WS	0986MF0022	5919WS	0986MF4750				
Dodge	Attitude	4 Cil, 1.6L	2006-2014	80081WS	0986MF0081	5821WS	0986MF4088				
Dodge	Attitude	4 Cil, 1.4L	2006-2014	80081WS	0986MF0081	5821WS	0986MF4088				
Dodge	Attitude	3 Cil, 1.2L	2015-2020	72273WS	F00E164931	84137WS	0986MF4137				
Dodge	Avenger	6 Cil, 3.5L	2008-2009	80013WS	0986MF0013	5815WS	0986MF4054				







											
Marca	Modelo	Motor	Año	Num. Corto	10 Dígitos	Num. Corto	10 Dígitos	Num. Corto	10 Dígitos		
Dodge	Avenger	4 Cil, 2.0L	2008-2010	80036WS	0986MF0036	5815WS	0986MF4054				
Dodge	Avenger	4 Cil, 2.4L	2008-2014	80013WS	0986MF0013	5815WS	0986MF4054				
Dodge	B2500	8 Cil, 5.2L	1995-1998	80036WS	0986MF0036						
Dodge	B3500	8 Cil, 5.2L	1995-1998	80036WS	0986MF0036						
Dodge	Caliber	4 Cil, 2.4L	2007-2008	80013WS	0986MF0013	84073WS	0986MF4073				
Dodge	Caliber	4 Cil, 2.4L	2009	80013WS	0986MF0013	84000WS	0986MF4000				
Dodge	Caliber	4 Cil, 2.4L	2012	80013WS	0986MF0013	84030WS	0986MF4030				
Dodge	Challenger	8 Cil, 6.1L	2008-2009	80029WS	0986MF0029	5900WS	0986MF4626				
Dodge	Challenger	8 Cil, 5.7L	2009-2014	80036WS	0986MF0036						
Dodge	Challenger	6 Cil, 3.6L	2017-2021	80046WS	0986MF0046						
Dodge	Challenger	8 Cil, 6.2L	2015-2021	80029WS	0986MF0029						
Dodge	Charger	6 Cil, 3.5L	2006-2008	80036WS	0986MF0036	5900WS	0986MF4626				
Dodge	Charger	8 Cil, 5.7L	2006-2008	80036WS	0986MF0036	5900WS	0986MF4626				
Dodge	Charger	8 Cil, 6.1L	2008-2010	80029WS	0986MF0029	5900WS	0986MF4626				
Dodge	Charger	8 Cil, 6.4L	2012-2014	80029WS	0986MF0029						
Dodge	Charger	8 Cil, 5.7L	2010-2019	80013WS	0986MF0013	5900WS	0986MF4626				
Dodge	Charger	8 Cil, 6.2L	2015-2020	80029WS	0986MF0029						
Dodge	D100	6 Cil, 3.7L	1975-1980					82890WS	0986MF2890		
Dodge	D100	8 Cil, 5.9L	1976-1980					82890WS	0986MF2890		
Dodge	D150	6 Cil, 3.7L	1981-1982					82890WS	0986MF2890		
Dodge	D150	6 Cil, 3.7L	1983-1990	80036WS	0986MF0036						
Dodge	D150	6 Cil, 3.9L	1991	80036WS	0986MF0036						
Dodge	D300	8 Cil, 5.9L	1975-1979					82890WS	0986MF2890		
Dodge	D300	6 Cil, 3.7L	1975-1980					82890WS	0986MF2890		
Dodge	D300	8 Cil, 5.9L	1980					82890WS	0986MF2890		
Dodge	D350	8 Cil, 5.9L	1981-1982					82890WS	0986MF2890		
Dodge	D350	6 Cil, 3.7L	1981-1987					82890WS	0986MF2890		
Dodge	Dakota	6 Cil, 3.7L	2005-2007	80031WS	0986MF0031	5931WS	0986MF4901				
Dodge	Dakota	6 Cil, 3.7L	2008-2009	80031WS	0986MF0031	84040WS	0986MF4040				
Dodge	Dakota	4 Cil, 2.5L	1996			84239WS	0986MF4239				
Dodge	Dakota	6 Cil, 3.7L	2011			84040WS	0986MF4040				
Dodge	Dart	8 Cil, 5.9L	1976					82890WS	0986MF2890		







		 Cil.  CC				Filtro de aceite 		Filtro de aire 		Filtro de gasolina 	
Marca	Modelo	Motor	Año	Num. Corto	10 Dígitos	Num. Corto	10 Dígitos	Num. Corto	10 Dígitos	Num. Corto	10 Dígitos
Dodge	Dart	6 Cil, 3.7L	1977-1981	80017WS	0986MF0017			82890WS	0986MF2890		
Dodge	Dart	4 Cil, 2.2L	1982-1989	80034WS	0986MF0034	84239WS	0986MF4239				
Dodge	Dart	4 Cil, 2.5L	1989	80034WS	0986MF0034						
Dodge	Dart	4 Cil, 2.4L	2014-2016	80013WS	0986MF0013	84209WS	0986MF4209				
Dodge	Durango	8 Cil, 4.7L	2001-2003	80036WS	0986MF0036	5931WS	0986MF4901				
Dodge	Durango	8 Cil, 5.7L	2004-2008	80029WS	0986MF0029						
Dodge	Durango	8 Cil, 5.2L	1998-2000	80036WS	0986MF0036	5931WS	0986MF4901				
Dodge	Durango	8 Cil, 5.9L	1999-2003	80036WS	0986MF0036	5931WS	0986MF4901				
Dodge	Durango	8 Cil, 4.7L	2005-2007	80036WS	0986MF0036	84035WS	0986MF4035				
Dodge	Durango	8 Cil, 5.7L	2012-2013	80013WS	0986MF0013	84257WS	0986MF4257				
Dodge	Durango	6 Cil, 3.6L	2020	80046WS	0986MF0046	84257WS	0986MF4257				
Dodge	Durango	8 Cil, 5.7L	2009-2021	80013WS	0986MF0013	84257WS	0986MF4257				
Dodge	Grand Caravan	6 Cil, 3.6L	2017-2020	80046WS	0986MF0046	84182WS	0986MF4182				
Dodge	H100	4 Cil, 2.4L	2003-2005	80081WS	0986MF0081						
Dodge	H100 - Diesel	4 Cil, 2.5L	2006-2010	72285WS	0986MF0240	5945WS	0986MF4811				
Dodge	H100 Van - Diesel	4 Cil, 2.5L	2010-2013	72285WS	0986MF0240	5945WS	0986MF4811				
Dodge	i10	4 Cil, 1.1L	2012-2014	80022WS	0986MF0022	84057WS	0986MF4057				
Dodge	Intrepid	6 Cil, 3.2L	1998-2000	80036WS	0986MF0036	84089WS	0986MF4089				
Dodge	Intrepid	6 Cil, 3.5L	2000-2001	80036WS	0986MF0036	84089WS	0986MF4089				
Dodge	Journey	6 Cil, 3.6L	2014-2019	80046WS	0986MF0046	84034WS	0986MF4034				
Dodge	Journey	6 Cil, 3.5L	2009-2010	80013WS	0986MF0013	5815WS	0986MF4054				
Dodge	Journey	4 Cil, 2.4L	2009-2020	80013WS	0986MF0013	5815WS	0986MF4054				
Dodge	Neon	4 Cil, 2.0L	1998-2005	80034WS	0986MF0034	84234WS	0986MF4234				
Dodge	Neon	4 Cil, 2.4L	2004-2005	80034WS	0986MF0034	84248WS	0986MF4248				
Dodge	Nitro	6 Cil, 4.0L	2007-2010	80036WS	0986MF0036	84013WS	0986MF4013				
Dodge	Nitro	6 Cil, 3.7L	2007-2011	80031WS	0986MF0031	84013WS	0986MF4013				
Dodge	Ram 1500	8 Cil, 5.2L	1995-2000	80036WS	0986MF0036	5931WS	0986MF4901				
Dodge	Ram 1500	8 Cil, 5.9L	1995-2001	80036WS	0986MF0036	5931WS	0986MF4901				
Dodge	Ram 1500	6 Cil, 3.9L	1994-2002	80036WS	0986MF0036	5931WS	0986MF4901				
Dodge	Ram 1500	10 Cil, 8.3L	2005-2006	80036WS	0986MF0036	84072WS	0986MF4072				
Dodge	Ram 1500	8 Cil, 5.7L	2006	80036WS	0986MF0036						
Dodge	Ram 1500	6 Cil, 3.7L	2003-2008	80031WS	0986MF0031						







											
Marca	Modelo	Motor	Año	Num. Corto	10 Dígitos	Num. Corto	10 Dígitos	Num. Corto	10 Dígitos		
Dodge	Ram 1500	8 Cil, 5.7L	2008	80029WS	0986MF0029						
Dodge	Ram 1500	8 Cil, 4.7L	2003-2009	80036WS	0986MF0036						
Dodge	Ram 1500	6 Cil, 3.7L	2009-2010	80013WS	0986MF0013						
Dodge	Ram 1500 Van	8 Cil, 5.2L	1995-2002	80036WS	0986MF0036						
Dodge	Ram 1500 Van	6 Cil, 3.9L	1997-2003	80036WS	0986MF0036						
Dodge	Ram 2500	8 Cil, 5.9L	1995-2002	80036WS	0986MF0036	5931WS	0986MF4901				
Dodge	Ram 2500	8 Cil, 5.2L	1997-2001	80036WS	0986MF0036						
Dodge	Ram 2500	8 Cil, 5.7L	2003-2008	80036WS	0986MF0036						
Dodge	Ram 2500	8 Cil, 4.7L	2002-2009	80036WS	0986MF0036						
Dodge	Ram 2500	8 Cil, 5.7L	2009	80013WS	0986MF0013						
Dodge	Ram 2500	6 Cil, 5.9L	2006-2010			84072WS	0986MF4072				
Dodge	Ram 2500 Van	8 Cil, 5.2L	1996-2002	80036WS	0986MF0036						
Dodge	Ram 3500	8 Cil, 5.9L	1994-2002	80036WS	0986MF0036	5931WS	0986MF4901				
Dodge	Ram 3500 Van	8 Cil, 5.2L	1999-2002	80036WS	0986MF0036						
Dodge	Ram 3500 Van	8 Cil, 5.9L	1997-2002	80036WS	0986MF0036						
Dodge	Ram 4000	8 Cil, 5.7L	2002-2009	80036WS	0986MF0036						
Dodge	Ram 4000	6 Cil, 5.9L	2005-2009			84072WS	0986MF4072				
Dodge	Ramcharger	8 Cil, 5.9L	1984-1994	80036WS	0986MF0036	5845WS	0986MF4347				
Dodge	Ramcharger	8 Cil, 5.9L	1995-2001			5931WS	0986MF4901				
Dodge	Royal Monaco	8 Cil, 5.9L	1977	80036WS	0986MF0036						
Dodge	Stratus	4 Cil, 2.0L	1998-2006	80034WS	0986MF0034	5866WS	0986MF4432				
Dodge	Stratus	4 Cil, 2.4L	1998-2000	80034WS	0986MF0034	5866WS	0986MF4432				
Dodge	Stratus	4 Cil, 2.4L	2001-2006	80034WS	0986MF0034	84024WS	0986MF4024				
Dodge	Van 1000	4 Cil, 2.4L	2008-2009	80081WS	0986MF0081			82892WS	0986MF2892		
Dodge	Verna	4 Cil, 1.5L	2004-2006	80081WS	0986MF0081	5942WS	0986MF4970	82898WS	0986MF2898		
Dodge	Verna	4 Cil, 1.6L	2004-2006	80081WS	0986MF0081	5942WS	0986MF4970	82898WS	0986MF2898		
Dodge	Viper	10 Cil, 8.0L	1992-1994	80036WS	0986MF0036						
Dodge	Viper	10 Cil, 8.0L	2000	80036WS	0986MF0036						
Dodge	Viper	10 Cil, 8.3L	2003-2006	80036WS	0986MF0036						
Dodge	Viper	10 Cil, 8.4L	2008-2010	80029WS	0986MF0029						
Dodge	Vision	4 Cil, 1.6L	2015-2018			84150WS	0986MF4150				
Dodge	W150	6 Cil, 3.7L	1985-1986	80031WS	0986MF0031						







		 Cil.  CC				Filtro de aceite 		Filtro de aire 		Filtro de gasolina 	
Marca	Modelo	Motor	Año	Num. Corto	10 Dígitos	Num. Corto	10 Dígitos	Num. Corto	10 Dígitos		
Dodge	W150	8 Cil, 5.9L	1985-1986	80036WS	0986MF0036						
Fiat	500X	4 Cil, 2.4L	2016-2017	80013WS	0986MF0013						
Fiat	Mobi	4 Cil, 1.0L	2017-2020	72273WS	F00E164931			82426WS	0986MF2426		
Fiat	Palio	4 Cil, 1.6L	2013-2020			84150WS	0986MF4150				
Fiat	Punto	4 Cil, 1.4L	2013	72273WS	F00E164931						
Fiat	Strada	4 Cil, 1.8L	2007-2011	80039WS	0986MF0039						
Fiat	Uno	4 Cil, 1.4L	2013-2020	72273WS	F00E164931			82426WS	0986MF2426		
Ford	Aerostar	6 Cil, 3.0L	1991-1992	80031WS	0986MF0031			77124WS	0986MF2018		
Ford	Aerostar	6 Cil, 4.0L	1993-1995	80017WS	0986MF0017			77121WS	0986MF2011		
Ford	B-100	8 Cil, 5.0L	1975-1979	80029WS	0986MF0029						
Ford	B-150	8 Cil, 5.0L	1981-1985	80029WS	0986MF0029						
Ford	B-200	8 Cil, 5.0L	1985-1991	80029WS	0986MF0029						
Ford	Club Wagon	8 Cil, 5.8L	1995-1996			5851WS	0986MF4366	77124WS	0986MF2018		
Ford	Club Wagon	8 Cil, 5.4L	1997-1998					77124WS	0986MF2018		
Ford	Contour	4 Cil, 2.0L	1996	80036WS	0986MF0036	84264WS	0986MF4264	77121WS	0986MF2011		
Ford	Contour	6 Cil, 2.5L	1996-2000	80029WS	0986MF0029			77121WS	0986MF2011		
Ford	Cougar	6 Cil, 3.8L	1990-1994	80031WS	0986MF0031						
Ford	Courier	4 Cil, 1.6L	2001-2012	80031WS	0986MF0031	5886WS	0986MF4580	77124WS	0986MF2018		
Ford	Crown Victoria	8 Cil, 4.6L	1998-2000	80029WS	0986MF0029	5816WS	0986MF4056	77170WS	0986MF2133		
Ford	Crown Victoria	8 Cil, 4.6L	2001-2007	80029WS	0986MF0029	5816WS	0986MF4056	77170WS	0986MF2133		
Ford	Crown Victoria	8 Cil, 4.6L	2009-2011	80029WS	0986MF0029	5816WS	0986MF4056	77170WS	0986MF2133		
Ford	E-150	6 Cil, 4.2L	1999-2003	80017WS	0986MF0017	5811WS	0986MF4004	77124WS	0986MF2018		
Ford	E-150	8 Cil, 5.4L	2003-2007					77170WS	0986MF2133		
Ford	E-150	8 Cil, 5.4L	2000-2008					77124WS	0986MF2018		
Ford	E-150	8 Cil, 4.6L	2004-2009					77170WS	0986MF2133		
Ford	E-150 Econoline	8 Cil, 5.4L	1997-1999					77124WS	0986MF2018		
Ford	E-250 Econoline	6 Cil, 4.9L	1995-1996			5851WS	0986MF4366	77124WS	0986MF2018		
Ford	E-250 Econoline	8 Cil, 5.4L	1997-2000					77124WS	0986MF2018		
Ford	E-350 Club Wagon	8 Cil, 5.4L	2000-2002					77124WS	0986MF2018		
Ford	E-350 Club Wagon	8 Cil, 5.4L	2003					77170WS	0986MF2133		
Ford	E-350 Club Wagon	8 Cil, 6.0L	2005-2007			84075WS	0986MF4075				
Ford	E-350 Econoline	8 Cil, 5.4L	1999					77124WS	0986MF2018		







											
Marca	Modelo	Motor	Año	Num. Corto	10 Dígitos	Num. Corto	10 Dígitos	Num. Corto	10 Dígitos		
Ford	E-350 Econoline	8 Cil, 5.4L	2006-2008					77170WS	0986MF2133		
Ford	Econoline	8 Cil, 4.6L	2004-2006	80029WS	0986MF0029	5811WS	0986MF4004	77170WS	0986MF2133		
Ford	Econoline Van	8 Cil, 4.6L	2010-2014	80029WS	0986MF0029						
Ford	Econoline Wagon	8 Cil, 4.6L	2010	80029WS	0986MF0029	5811WS	0986MF4004	77170WS	0986MF2133		
Ford	Econoline Wagon	8 Cil, 5.4L	2010-2014					77170WS	0986MF2133		
Ford	EcoSport	4 Cil, 2.0L	2008-2009	80034WS	0986MF0034	5899WS	0986MF4621	77170WS	0986MF2133		
Ford	EcoSport	4 Cil, 2.0L	2013-2017	80034WS	0986MF0034	84161WS	0986MF4161	77170WS	0986MF2133		
Ford	EcoSport	4 Cil, 2.0L	2010-2012	80034WS	0986MF0034	84161WS	0986MF4161	77170WS	0986MF2133		
Ford	EcoSport	3 Cil, 1.5L	2018-2020	80049WS	0986MF0049	84032WS	0986MF4032	77170WS	0986MF2133		
Ford	EcoSport	4 Cil, 2.0L	2018-2021	80034WS	0986MF0034	84032WS	0986MF4032	77170WS	0986MF2133		
Ford	Edge	6 Cil, 3.5L	2007-2014	80031WS	0986MF0031	84015WS	0986MF4015				
Ford	Edge	6 Cil, 2.7L	2016-2018			84159WS	0986MF4159				
Ford	Edge	4 Cil, 2.0L	2017-2021	80034WS	0986MF0034	84159WS	0986MF4159				
Ford	Edge	6 Cil, 2.7L	2019-2021			84159WS	0986MF4159				
Ford	Escape	4 Cil, 2.0L	2014-2020	80034WS	0986MF0034	84032WS	0986MF4032				
Ford	Escape	6 Cil, 3.0L	2001-2008	80029WS	0986MF0029	5943WS	0986MF4997	77121WS	0986MF2011		
Ford	Escape	4 Cil, 2.5L	2011-2012	80034WS	0986MF0034	5943WS	0986MF4997	77124WS	0986MF2018		
Ford	Escape	6 Cil, 3.0L	2009-2012			84031WS	0986MF4031	77124WS	0986MF2018		
Ford	Escape	4 Cil, 2.5L	2013-2019	80034WS	0986MF0034	84177WS	0986MF4177				
Ford	Escort	4 Cil, 2.0L	1997-2001	80031WS	0986MF0031	5826WS	0986MF4142				
Ford	Escort	4 Cil, 1.8L	1994-1995	80022WS	0986MF0022			77121WS	0986MF2011		
Ford	Escort	4 Cil, 1.9L	1994-1996	80031WS	0986MF0031	84234WS	0986MF4234	77121WS	0986MF2011		
Ford	Excursion	10 Cil, 6.8L	2001-2005	80029WS	0986MF0029	5811WS	0986MF4004	77124WS	0986MF2018		
Ford	Expedition	8 Cil, 4.6L	1997-2000	80029WS	0986MF0029	5811WS	0986MF4004	77124WS	0986MF2018		
Ford	Expedition	8 Cil, 4.6L	2001-2004	80029WS	0986MF0029	5811WS	0986MF4004	77124WS	0986MF2018		
Ford	Expedition	8 Cil, 5.4L	1997-2004	80029WS	0986MF0029	5811WS	0986MF4004	77124WS	0986MF2018		
Ford	Expedition	8 Cil, 5.4L	2005-2008	80029WS	0986MF0029	84066WS	0986MF4066				
Ford	Expedition	8 Cil, 5.4L	2009-2014	80029WS	0986MF0029	84066WS	0986MF4066				
Ford	Expedition	6 Cil, 3.5L	2015-2021			84066WS	0986MF4066				
Ford	Explorer	6 Cil, 4.0L	1991-1996	80017WS	0986MF0017	5924WS	0986MF4774	77124WS	0986MF2018		
Ford	Explorer	6 Cil, 4.0L	1998	80017WS	0986MF0017	84263WS	0986MF4263	77124WS	0986MF2018		
Ford	Explorer	6 Cil, 4.0L	1997-2000	80017WS	0986MF0017	5835WS	0986MF4243	77124WS	0986MF2018		







		 Cil.  CC				Filtro de aceite 		Filtro de aire 		Filtro de gasolina 	
Marca	Modelo	Motor	Año	Num. Corto	10 Dígitos	Num. Corto	10 Dígitos	Num. Corto	10 Dígitos	Num. Corto	10 Dígitos
Ford	Explorer	6 Cil, 4.0L	2001	80029WS	0986MF0029	5835WS	0986MF4243	77124WS	0986MF2018		
Ford	Explorer	8 Cil, 5.0L	1996-2001	80029WS	0986MF0029	84263WS	0986MF4263	77124WS	0986MF2018		
Ford	Explorer	6 Cil, 4.0L	2002-2005	80029WS	0986MF0029	84246WS	0986MF4246	77124WS	0986MF2018		
Ford	Explorer	8 Cil, 4.6L	2002-2005	80029WS	0986MF0029	84246WS	0986MF4246	77124WS	0986MF2018		
Ford	Explorer	6 Cil, 4.0L	2009	80029WS	0986MF0029	84246WS	0986MF4246	77124WS	0986MF2018		
Ford	Explorer	6 Cil, 4.0L	2006-2010	80029WS	0986MF0029	84246WS	0986MF4246	77124WS	0986MF2018		
Ford	Explorer	8 Cil, 4.6L	2006-2010	80029WS	0986MF0029	84156WS	0986MF4156				
Ford	Explorer	6 Cil, 3.5L	2011-2019			84016WS	0986MF4016				
Ford	Explorer Sport	6 Cil, 4.0L	2001-2003	80029WS	0986MF0029	84246WS	0986MF4246	77124WS	0986MF2018		
Ford	Explorer Sport Trac	8 Cil, 4.6L	2007-2010	80029WS	0986MF0029	84156WS	0986MF4156				
Ford	F-100	8 Cil, 4.7L	1966-1972	80017WS	0986MF0017						
Ford	F-100	8 Cil, 5.0L	1978-1979	80017WS	0986MF0017						
Ford	F-100 Ranger	4 Cil, 2.3L	1996-1997	80017WS	0986MF0017	5924WS	0986MF4774				
Ford	F-100 Ranger	6 Cil, 3.0L	1996-1997	80031WS	0986MF0031	5924WS	0986MF4774				
Ford	F-100 Ranger	4 Cil, 2.5L	1998-2000	80031WS	0986MF0031	84263WS	0986MF4263				
Ford	F-150	8 Cil, 5.0L	1980-1985	80017WS	0986MF0017						
Ford	F-150	8 Cil, 5.8L	1984-1985	80017WS	0986MF0017						
Ford	F-150	6 Cil, 3.8L	1986-1990	80031WS	0986MF0031			77121WS	0986MF2011		
Ford	F-150	6 Cil, 3.8L	1991-1994	80031WS	0986MF0031			77121WS	0986MF2011		
Ford	F-150	6 Cil, 4.9L	1995-1996	80017WS	0986MF0017	5851WS	0986MF4366	77124WS	0986MF2018		
Ford	F-150	6 Cil, 4.9L	1997	80017WS	0986MF0017			77124WS	0986MF2018		
Ford	F-150	6 Cil, 4.2L	1998-2003	80031WS	0986MF0031			77124WS	0986MF2018		
Ford	F-150	6 Cil, 4.2L	2005-2008	80031WS	0986MF0031			77170WS	0986MF2133		
Ford	F-150	6 Cil, 4.2L	2009-2010	80031WS	0986MF0031			77124WS	0986MF2018		
Ford	F-150	6 Cil, 3.5L	2015-2017			84066WS	0986MF4066				
Ford	F-150	8 Cil, 5.0L	2011-2017			84066WS	0986MF4066				
Ford	F-200	8 Cil, 5.0L	1986-1991	80017WS	0986MF0017						
Ford	F-250	8 Cil, 5.8L	1992-1993	80017WS	0986MF0017	5851WS	0986MF4366	77124WS	0986MF2018		
Ford	F-250	8 Cil, 4.9L	1992-1997	80017WS	0986MF0017	5851WS	0986MF4366	77124WS	0986MF2018		
Ford	F-250	8 Cil, 5.8L	1994-1997	80029WS	0986MF0029	5851WS	0986MF4366	77124WS	0986MF2018		
Ford	F-250	8 Cil, 4.6L	1997-1999	80029WS	0986MF0029			77124WS	0986MF2018		
Ford	F-250	8 Cil, 4.6L	1999-2001	80029WS	0986MF0029	5811WS	0986MF4004	77170WS	0986MF2133		







											
Marca	Modelo	Motor	Año	Num. Corto	10 Dígitos	Num. Corto	10 Dígitos	Num. Corto	10 Dígitos	Num. Corto	10 Dígitos
Ford	F-250	8 Cil, 5.4L	2000-2001	80029WS	0986MF0029	5811WS	0986MF4004	77170WS	0986MF2133		
Ford	F-250	8 Cil, 4.6L	2002-2009	80029WS	0986MF0029			77170WS	0986MF2133		
Ford	F-350	8 Cil, 5.0L	1975-1981	80017WS	0986MF0017						
Ford	F-350	8 Cil, 5.8L	1986-1990	80017WS	0986MF0017	5851WS	0986MF4366	77121WS	0986MF2011		
Ford	F-350	8 Cil, 5.0L	1982-1992	80017WS	0986MF0017	5851WS	0986MF4366				
Ford	F-350	8 Cil, 5.8L	1995-1996	80029WS	0986MF0029	5851WS	0986MF4366	77124WS	0986MF2018		
Ford	F-350	8 Cil, 5.0L	1993-1998	80017WS	0986MF0017	5851WS	0986MF4366	77124WS	0986MF2018		
Ford	F-350	8 Cil, 5.4L	2002-2003	80029WS	0986MF0029						
Ford	F-350	8 Cil, 5.4L	1999-2004	80029WS	0986MF0029			77124WS	0986MF2018		
Ford	F-350	8 Cil, 5.4L	2005-2009	80029WS	0986MF0029	84066WS	0986MF4066	77170WS	0986MF2133		
Ford	F-350	8 Cil, 6.2L	2011-2016	80029WS	0986MF0029	84066WS	0986MF4066				
Ford	F-350 Super Duty	8 Cil, 6.2L	2017-2021	80029WS	0986MF0029						
Ford	F-450 Super Duty	10 Cil, 6.8L	2005-2007	80029WS	0986MF0029	84019WS	0986MF4019				
Ford	F-450 Super Duty	10 Cil, 6.8L	1998-2004	80029WS	0986MF0029						
Ford	F-450 Super Duty	8 Cil, 6.7L	2011-2020			84200WS	0986MF4200				
Ford	F-550 Super Duty	10 Cil, 6.8L	2001-2004	80029WS	0986MF0029						
Ford	F-550 Super Duty	10 Cil, 6.8L	2005-2019	80029WS	0986MF0029						
Ford	F-550 Super Duty	8 Cil, 6.7L	2011-2020			84200WS	0986MF4200				
Ford	Fairmont	8 Cil, 5.0L	1978-1983	80017WS	0986MF0017						
Ford	Fiesta	4 Cil, 1.6L	2011-2019	80034WS	0986MF0034	84064WS	0986MF4064				
Ford	Fiesta	4 Cil, 1.3L	1998-2001	80031WS	0986MF0031	5886WS	0986MF4580				
Ford	Fiesta	4 Cil, 1.6L	2001-2004	80031WS	0986MF0031	84235WS	0986MF4235				
Ford	Fiesta	4 Cil, 1.6L	2003-2007	80031WS	0986MF0031	84235WS	0986MF4235	77170WS	0986MF2133		
Ford	Fiesta	4 Cil, 2.0L	2008	80034WS	0986MF0034	84235WS	0986MF4235				
Ford	Fiesta	4 Cil, 1.6L	2008-2010	80034WS	0986MF0034	84235WS	0986MF4235	77170WS	0986MF2133		
Ford	Fiesta Ikon	4 Cil, 1.6L	2002	80031WS	0986MF0031	5886WS	0986MF4580				
Ford	Fiesta Ikon	4 Cil, 1.6L	2003-2004	80031WS	0986MF0031	84235WS	0986MF4235				
Ford	Fiesta Ikon	4 Cil, 1.6L	2011-2015	80031WS	0986MF0031	84064WS	0986MF4064				
Ford	Figo	3 Cil, 1.5L	2019-2020								
Ford	Figo	4 Cil, 1.5L	2016-2018	80034WS	0986MF0034	84064WS	0986MF4064				
Ford	Five Hundred	6 Cil, 3.0L	2005-2007	80029WS	0986MF0029	84256WS	0986MF4256	77170WS	0986MF2133		
Ford	Focus	4 Cil, 2.0L	2012-2018	80034WS	0986MF0034	84032WS	0986MF4032				







		 									
Marca	Modelo	Motor	Año	Num. Corto	10 Dígitos	Num. Corto	10 Dígitos	Num. Corto	10 Dígitos		
Ford	Focus	4 Cil, 2.0L	2000-2004	80031WS	0986MF0031	5908WS	0986MF4688	77170WS	0986MF2133		
Ford	Focus	4 Cil, 2.0L	2005-2007	80034WS	0986MF0034			77170WS	0986MF2133		
Ford	Focus	4 Cil, 2.0L	2008-2010	80034WS	0986MF0034	84018WS	0986MF4018				
Ford	Focus	5 Cil, 2.5L	2010-2011	80034WS	0986MF0034						
Ford	Freestar	6 Cil, 4.2L	2004-2007	80031WS	0986MF0031	84071WS	0986MF4071	77170WS	0986MF2133		
Ford	Fusion	4 Cil, 2.0L	2013-2020	80034WS	0986MF0034	84159WS	0986MF4159				
Ford	Fusion	6 Cil, 3.0L	2006-2009	80029WS	0986MF0029	84016WS	0986MF4016				
Ford	Fusion	4 Cil, 2.3L	2007-2010			84020WS	0986MF4020				
Ford	Fusion	4 Cil, 2.5L	2010-2012	80034WS	0986MF0034	84020WS	0986MF4020				
Ford	Fusion	6 Cil, 3.0L	2010-2012			84016WS	0986MF4016				
Ford	Fusion	4 Cil, 2.5L	2013-2018	80034WS	0986MF0034	84159WS	0986MF4159				
Ford	Galaxie 500	8 Cil, 5.8L	1970-1974	80017WS	0986MF0017						
Ford	Ghia	6 Cil, 3.0L	1991-1992			84250WS	0986MF4250				
Ford	Ghia	6 Cil, 3.0L	1993-1994			84247WS	0986MF4247				
Ford	Grand Marquis	8 Cil, 4.6L	1991-1999	80029WS	0986MF0029	5816WS	0986MF4056	77121WS	0986MF2011		
Ford	Grand Marquis	8 Cil, 4.6L	2000-2004	80029WS	0986MF0029	5816WS	0986MF4056	77170WS	0986MF2133		
Ford	Ikon	4 Cil, 1.6L	2003-2007	80031WS	0986MF0031	84064WS	0986MF4064				
Ford	Ka	4 Cil, 1.6L	2001-2008	80024WS	0986MF0024	5915WS	0986MF4736	77170WS	0986MF2133		
Ford	Lobo	8 Cil, 5.4L	2002-2004	80029WS	0986MF0029	5811WS	0986MF4004	77170WS	0986MF2133		
Ford	Lobo	8 Cil, 5.4L	1999-2004	80029WS	0986MF0029	5811WS	0986MF4004	77170WS	0986MF2133		
Ford	Lobo	8 Cil, 5.4L	2005-2007	80029WS	0986MF0029	84162WS	0986MF4162	77170WS	0986MF2133		
Ford	Lobo	8 Cil, 4.6L	2002-2008	80029WS	0986MF0029	5811WS	0986MF4004	77170WS	0986MF2133		
Ford	Lobo	8 Cil, 4.6L	2003-2008	80029WS	0986MF0029	5811WS	0986MF4004	77170WS	0986MF2133		
Ford	Lobo	6 Cil, 3.5L	2015-2020			84066WS	0986MF4066				
Ford	Lobo	8 Cil, 4.6L	1997-1999	80029WS	0986MF0029	5811WS	0986MF4004	77124WS	0986MF2018		
Ford	Lobo	8 Cil, 4.6L	2000-2001	80029WS	0986MF0029	5811WS	0986MF4004	77170WS	0986MF2133		
Ford	Lobo	8 Cil, 4.6L	2009-2010	80029WS	0986MF0029	84066WS	0986MF4066	77170WS	0986MF2133		
Ford	Lobo	8 Cil, 6.2L	2011-2014	80029WS	0986MF0029						
Ford	Lobo	8 Cil, 5.0L	2011-2015	80029WS	0986MF0029	84066WS	0986MF4066				
Ford	Lobo	8 Cil, 5.0L	2016-2017	80029WS	0986MF0029						
Ford	LTD	8 Cil, 5.8L	1975-1980	80017WS	0986MF0017						
Ford	Maverick	8 Cil, 5.0L	1971-1977	80029WS	0986MF0029						







											
Marca	Modelo	Motor	Año	Num. Corto	10 Dígitos	Num. Corto	10 Dígitos	Num. Corto	10 Dígitos	Num. Corto	10 Dígitos
Ford	Mustang	8 Cil, 5.0L	1979-1983	80017WS	0986MF0017			82890WS	0986MF2890		
Ford	Mustang	8 Cil, 5.0L	1984	80017WS	0986MF0017						
Ford	Mustang	8 Cil, 5.0L	1994-1995	80017WS	0986MF0017	5914WS	0986MF4730	77121WS	0986MF2011		
Ford	Mustang	8 Cil, 4.6L	1996-2004	80029WS	0986MF0029	5811WS	0986MF4004	77121WS	0986MF2011		
Ford	Mustang	6 Cil, 4.0L	2007-2010	80029WS	0986MF0029	84017WS	0986MF4017				
Ford	Mustang	8 Cil, 4.6L	2005-2010	80029WS	0986MF0029	84157WS	0986MF4157	77170WS	0986MF2133		
Ford	Mustang	8 Cil, 5.4L	2008-2012	80029WS	0986MF0029						
Ford	Mustang	8 Cil, 5.8L	2013-2014	80029WS	0986MF0029						
Ford	Mustang	6 Cil, 3.7L	2011-2017			84157WS	0986MF4157				
Ford	Mustang	8 Cil, 5.0L	2011-2018			84157WS	0986MF4157				
Ford	Mustang	4 Cil, 2.3L	2016-2021	80034WS	0986MF0034						
Ford	Mustang II	8 Cil, 5.0L	1975-1978	80017WS	0986MF0017	5853WS	0986MF4381				
Ford	Mystique	6 Cil, 2.5L	1995-2000	80029WS	0986MF0029	84264WS	0986MF4264	77121WS	0986MF2011		
Ford	P-350	8 Cil, 5.0L	1975	80029WS	0986MF0029						
Ford	P-350	8 Cil, 5.0L	1989-1994	80029WS	0986MF0029						
Ford	P-350	8 Cil, 5.8L	1996-1997					77124WS	0986MF2018		
Ford	P-400	8 Cil, 5.0L	1975	80029WS	0986MF0029						
Ford	Ranger	4 Cil, 2.3L	2001-2012	80031WS	0986MF0031	5835WS	0986MF4243				
Ford	Ranger	6 Cil, 3.0L	1998-2002	80031WS	0986MF0031	84263WS	0986MF4263				
Ford	Ranger	4 Cil, 2.2L	2015-2018			84152WS	0986MF4152				
Ford	Ranger	4 Cil, 2.5L	2013-2021	80034WS	0986MF0034	84152WS	0986MF4152				
Ford	Sable	6 Cil, 3.0L	1996-1999	80031WS	0986MF0031	84247WS	0986MF4247	77121WS	0986MF2011		
Ford	Sable	6 Cil, 3.8L	1994-1995	80031WS	0986MF0031			77121WS	0986MF2011		
Ford	Sable	6 Cil, 3.0L	2000-2001	80031WS	0986MF0031	5943WS	0986MF4997	77121WS	0986MF2011		
Ford	Taurus	6 Cil, 3.8L	1988-1991	80031WS	0986MF0031			77121WS	0986MF2011		
Ford	Thunderbird	6 Cil, 3.8L	1985-1989	80031WS	0986MF0031	84260WS	0986MF4260	77121WS	0986MF2011		
Ford	Thunderbird	8 Cil, 5.0L	1991-1993	80029WS	0986MF0029	84260WS	0986MF4260				
Ford	Thunderbird	6 Cil, 3.8L	1990-1994	80031WS	0986MF0031	84260WS	0986MF4260				
Ford	Thunderbird	8 Cil, 4.6L	1994-1996	80029WS	0986MF0029	84260WS	0986MF4260				
Ford	Thunderbird	8 Cil, 3.9L	2003			84071WS	0986MF4071	77170WS	0986MF2133		
Ford	Topaz	4 Cil, 2.3L	1988-1992			84250WS	0986MF4250				
Ford	Topaz	4 Cil, 2.3L	1993-1994			84247WS	0986MF4247				







		 									
Marca	Modelo	Motor	Año	Num. Corto	10 Dígitos	Num. Corto	10 Dígitos	Num. Corto	10 Dígitos		
Ford	Transit	4 Cil, 2.2L	2014-2016								
Ford	Transit - Diesel	4 Cil, 2.2L	2007-2011	80001WS	0986MF0001	84187WS	0986MF4187				
Ford	Transit Custom	4 Cil, 2.2L	2014-2016			84154WS	0986MF4154				
Ford	Windstar	6 Cil, 3.8L	1995-2003	80031WS	0986MF0031	5924WS	0986MF4774	77124WS	0986MF2018		
GMC	Acadia	6 Cil, 3.6L	2007-2014	80013WS	0986MF0013	84044WS	0986MF4044				
GMC	Acadia	6 Cil, 3.6L	2009-2016			84044WS	0986MF4044				
GMC	Acadia	6 Cil, 3.6L	2017-2021			84044WS	0986MF4044				
GMC	Canyon	5 Cil, 3.7L	2007	80037WS	0986MF0037	84244WS	0986MF4244				
GMC	Canyon	5 Cil, 3.7L	2008-2012	80037WS	0986MF0037	84186WS	0986MF4186				
GMC	Sierra	8 Cil, 5.3L	2007-2013	80013WS	0986MF0013	5921WS	0986MF4755				
GMC	Sierra	8 Cil, 6.2L	2008-2013	80013WS	0986MF0013	5921WS	0986MF4755				
GMC	Sierra	8 Cil, 6.2L	2014-2017			5921WS	0986MF4755				
GMC	Sierra	8 Cil, 5.3L	2010-2016			5921WS	0986MF4755				
GMC	Terrain	6 Cil, 3.6L	2013-2017			84045WS	0986MF4045				
GMC	Terrain	4 Cil, 2.0L	2018-2021	80013WS	0986MF0013						
GMC	Yukon	8 Cil, 6.2L	2007-2008	80013WS	0986MF0013	5921WS	0986MF4755				
GMC	Yukon	8 Cil, 5.3L	2007-2010	80013WS	0986MF0013	5921WS	0986MF4755				
GMC	Yukon	8 Cil, 6.2L	2015-2021			5921WS	0986MF4755				
Honda	Accord	4 Cil, 2.4L	2003-2007	72273WS	F00E164931	84254WS	0986MF4254				
Honda	Accord	6 Cil, 3.0L	2003-2007	72273WS	F00E164931	84253WS	0986MF4253	82897WS	0986MF2897		
Honda	Accord	4 Cil, 2.2L	1996-1997	80081WS	0986MF0081	5863WS	0986MF4420	82893WS	0986MF2893		
Honda	Accord	4 Cil, 2.3L	1998-2002	80081WS	0986MF0081	5854WS	0986MF4395	82893WS	0986MF2893		
Honda	Accord	6 Cil, 3.0L	1998-2002	72273WS	F00E164931	84164WS	0986MF4164	82897WS	0986MF2897		
Honda	Accord	4 Cil, 2.4L	2008-2012	72273WS	F00E164931	84169WS	0986MF4169				
Honda	Accord	6 Cil, 3.5L	2008-2013	72273WS	F00E164931	84165WS	0986MF4165				
Honda	Accord	4 Cil, 2.4L	2013-2017	72273WS	F00E164931	84168WS	0986MF4168				
Honda	Accord	6 Cil, 3.5L	2014-2017	72273WS	F00E164931						
Honda	Accord	4 Cil, 1.5L	2018-2021	72273WS	F00E164931						
Honda	Accord	4 Cil, 2.0L	2018-2021	72273WS	F00E164931						
Honda	Accord Crosstour	6 Cil, 3.5L	2010-2012	72273WS	F00E164931	84165WS	0986MF4165				
Honda	BR-V	4 Cil, 1.5L	2018-2021	72273WS	F00E164931	84140WS	0986MF4140				
Honda	City	4 Cil, 1.5L	2010-2016	72273WS	F00E164931	84052WS	0986MF4052				







											
Marca	Modelo	Motor	Año	Num. Corto	10 Dígitos	Num. Corto	10 Dígitos	Num. Corto	10 Dígitos		
Honda	City	4 Cil, 1.5L	2017-2020	72273WS	F00E164931	84140WS	0986MF4140				
Honda	Civic	4 Cil, 1.3L	2006-2011	72273WS	F00E164931						
Honda	Civic	4 Cil, 1.6L	1997-2000	80081WS	0986MF0081	84061WS	0986MF4061	82893WS	0986MF2893		
Honda	Civic	4 Cil, 1.7L	2001-2005	72273WS	F00E164931	5933WS	0986MF4911				
Honda	Civic	4 Cil, 1.8L	2006-2011	72273WS	F00E164931	5912WS	0986MF4722				
Honda	Civic	4 Cil, 2.0L	2007-2011	72273WS	F00E164931	84240WS	0986MF4240				
Honda	Civic	4 Cil, 1.5L	2012-2013	72273WS	F00E164931						
Honda	Civic	4 Cil, 1.8L	2012-2015	72273WS	F00E164931	84153WS	0986MF4153				
Honda	Civic	4 Cil, 2.4L	2012-2015	72273WS	F00E164931						
Honda	Civic	4 Cil, 1.5L	2016-2020	72273WS	F00E164931	84166WS	0986MF4166				
Honda	Civic	4 Cil, 2.0L	2016-2020	72273WS	F00E164931	84203WS	0986MF4203				
Honda	Crosstour	6 Cil, 3.5L	2012	72273WS	F00E164931						
Honda	Crosstour	6 Cil, 3.5L	2013-2014	72273WS	F00E164931	84169WS	0986MF4169				
Honda	CR-V	4 Cil, 2.4L	2002-2006	72273WS	F00E164931	84240WS	0986MF4240	82893WS	0986MF2893		
Honda	CR-V	4 Cil, 2.4L	2007-2009	72273WS	F00E164931	84065WS	0986MF4065				
Honda	CR-V	4 Cil, 2.4L	2010-2011	72273WS	F00E164931	84047WS	0986MF4047				
Honda	CR-V	4 Cil, 2.4L	2015-2019	72273WS	F00E164931	84138WS	0986MF4138				
Honda	CR-V	4 Cil, 1.5L	2017-2021	72273WS	F00E164931	84166WS	0986MF4166				
Honda	CR-Z	4 Cil, 1.5L	2013-2015	72273WS	F00E164931						
Honda	Fit	4 Cil, 1.5L	2009-2014	72273WS	F00E164931	84052WS	0986MF4052				
Honda	Fit	4 Cil, 1.5L	2015-2020	72273WS	F00E164931	84053WS	0986MF4053				
Honda	Fit	4 Cil, 1.5L	2006-2008	72273WS	F00E164931	84133WS	0986MF4133				
Honda	HR-V	4 Cil, 1.8L	2016-2021	72273WS	F00E164931	84139WS	0986MF4139				
Honda	Insight	4 Cil, 1.5L	2019-2021	72273WS	F00E164931						
Honda	Odyssey	6 Cil, 3.5L	2000-2004	72273WS	F00E164931			82893WS	0986MF2893		
Honda	Odyssey	6 Cil, 3.5L	2005-2010	72273WS	F00E164931	84059WS	0986MF4059				
Honda	Odyssey	6 Cil, 3.5L	2011-2017	72273WS	F00E164931	84176WS	0986MF4176				
Honda	Odyssey	6 Cil, 3.5L	2018-2020	72273WS	F00E164931						
Honda	Pilot	6 Cil, 3.5L	2003-2008	72273WS	F00E164931	84196WS	0986MF4196				
Honda	Pilot	6 Cil, 3.5L	2009-2016	72273WS	F00E164931	84059WS	0986MF4059				
Honda	Pilot	6 Cil, 3.5L	2017-2021	72273WS	F00E164931						
Honda	Ridgeline	6 Cil, 3.5L	2007-2014	72273WS	F00E164931						







		 Cil.  CC				Filtro de aceite 		Filtro de aire 		Filtro de gasolina 	
Marca	Modelo	Motor	Año	Num. Corto	10 Dígitos	Num. Corto	10 Dígitos	Num. Corto	10 Dígitos	Num. Corto	10 Dígitos
Hummer	H2	8 Cil, 6.2L	2009	80013WS	0986MF0013						
Hummer	H3	5 Cil, 3.7L	2007			84244WS	0986MF4244				
Hummer	H3	5 Cil, 3.5L	2006			84244WS	0986MF4244				
Hummer	H3	5 Cil, 3.7L	2008-2010			84186WS	0986MF4186				
Hummer	H3	8 Cil, 5.3L	2008-2010			84186WS	0986MF4186				
Hummer	H3T	5 Cil, 3.7L	2010	80037WS	0986MF0037	84186WS	0986MF4186				
Hyundai	Accent	4 Cil, 1.6L	2018-2021	80081WS	0986MF0081						
Hyundai	Creta	4 Cil, 1.6L	2017-2020	80081WS	0986MF0081	84141WS	0986MF4141				
Hyundai	Elantra	4 Cil, 1.8L	2015-2016	80081WS	0986MF0081	84147WS	0986MF4147				
Hyundai	Elantra	4 Cil, 2.0L	2017-2020	80081WS	0986MF0081						
Hyundai	Grand i10	4 Cil, 1.2L	2018-2021	72273WS	F00E164931	84149WS	0986MF4149				
Hyundai	Grand i10	4 Cil, 1.3L	2015-2021	72273WS	F00E164931	84149WS	0986MF4149				
Hyundai	Ioniq	4 Cil, 1.6L	2018	80081WS	0986MF0081						
Hyundai	ix35	4 Cil, 2.0L	2015	80081WS	0986MF0081	84141WS	0986MF4141				
Hyundai	Santa Fe	4 Cil, 2.0L	2017-2020	80081WS	0986MF0081	84210WS	0986MF4210				
Hyundai	Sonata	4 Cil, 2.0L	2016-2018	80081WS	0986MF0081						
Hyundai	Sonata	4 Cil, 2.4L	2015-2018	80081WS	0986MF0081						
Hyundai	Tucson	4 Cil, 2.0L	2016-2021	80081WS	0986MF0081						
Infiniti	FX35	6 Cil, 3.5L	2012	80022WS	0986MF0022	84214WS	0986MF4214				
Infiniti	FX37	6 Cil, 3.7L	2013	80022WS	0986MF0022						
Infiniti	FX50	8 Cil, 5.0L	2012-2013	72273WS	F00E164931						
Infiniti	G37	6 Cil, 3.7L	2012-2013	80022WS	0986MF0022						
Infiniti	I30	6 Cil, 3.0L	1998-1999	72273WS	F00E164931	5841WS	0986MF4309	77213WS	0986MF2309		
Infiniti	I30	6 Cil, 3.0L	2000-2001	72273WS	F00E164931	5841WS	0986MF4309	77213WS	0986MF2309		
Infiniti	I35	6 Cil, 3.5L	2002-2003	72273WS	F00E164931	5841WS	0986MF4309				
Infiniti	JX35	6 Cil, 3.5L	2013	80022WS	0986MF0022	5841WS	0986MF4309				
Infiniti	M37	6 Cil, 3.7L	2012-2013	80022WS	0986MF0022						
Infiniti	M56	8 Cil, 5.6L	2012-2013	72273WS	F00E164931						
Infiniti	Q45	8 Cil, 4.5L	1994-1995	80027WS	0986MF0027			77213WS	0986MF2309		
Infiniti	Q45	8 Cil, 4.1L	1997-2001	72273WS	F00E164931			77213WS	0986MF2309		
Infiniti	Q45	8 Cil, 4.5L	2002-2006	72273WS	F00E164931			77213WS	0986MF2309		
Infiniti	Q50	6 Cil, 3.7L	2015-2018	80022WS	0986MF0022						







											
Marca	Modelo	Motor	Año	Num. Corto	10 Dígitos	Num. Corto	10 Dígitos	Num. Corto	10 Dígitos		
Infiniti	Q50	6 Cil, 3.0L	2017-2020	80022WS	0986MF0022	84214WS	0986MF4214				
Infiniti	Q50	6 Cil, 3.5L	2015-2020	80022WS	0986MF0022						
Infiniti	Q60	6 Cil, 3.7L	2014-2016	80022WS	0986MF0022						
Infiniti	Q70	6 Cil, 3.7L	2014-2019	80022WS	0986MF0022						
Infiniti	Q70	8 Cil, 5.6L	2014-2019	72273WS	F00E164931	84214WS	0986MF4214				
Infiniti	QX56	8 Cil, 5.6L	2012-2013	72273WS	F00E164931						
Infiniti	QX60	4 Cil, 2.5L	2015-2020	80022WS	0986MF0022	5841WS	0986MF4309				
Infiniti	QX60	6 Cil, 3.5L	2014-2020	80022WS	0986MF0022	5841WS	0986MF4309				
Infiniti	QX70	6 Cil, 3.7L	2014-2015	80022WS	0986MF0022	84214WS	0986MF4214				
Infiniti	QX70	6 Cil, 3.7L	2016-2020	80022WS	0986MF0022	5823WS	0986MF4100				
Infiniti	QX70	8 Cil, 5.0L	2014-2020	72273WS	F00E164931	5823WS	0986MF4100				
Infiniti	QX80	8 Cil, 5.6L	2014-2021	72273WS	F00E164931						
Jaguar	XE	4 Cil, 2.0L	2016-2017	80034WS	0986MF0034						
Jaguar	XF	4 Cil, 2.0L	2013-2015	80034WS	0986MF0034						
Jaguar	X-Type	6 Cil, 3.0L	2001-2008					77208WS	0986MF2273		
Jeep	Cherokee	6 Cil, 3.2L	2014-2020	80046WS	0986MF0046	84179WS	0986MF4179				
Jeep	Cherokee	6 Cil, 4.0L	1993-2001	80036WS	0986MF0036	5931WS	0986MF4901				
Jeep	Cherokee	4 Cil, 2.4L	2014-2017	80013WS	0986MF0013	84179WS	0986MF4179				
Jeep	Commander	8 Cil, 4.7L	2006-2007	80036WS	0986MF0036	5927WS	0986MF4817				
Jeep	Commander	8 Cil, 4.7L	2010	80029WS	0986MF0029						
Jeep	Compass	4 Cil, 2.4L	2009-2010	80013WS	0986MF0013	84073WS	0986MF4073				
Jeep	Compass	4 Cil, 2.4L	2012-2017	80013WS	0986MF0013	84030WS	0986MF4030				
Jeep	Compass	4 Cil, 2.4L	2018-2021	80013WS	0986MF0013						
Jeep	Grand Cherokee	8 Cil, 4.7L	2005-2009	80036WS	0986MF0036	5927WS	0986MF4817				
Jeep	Grand Cherokee	6 Cil, 4.0L	1993-1998	80036WS	0986MF0036	84232WS	0986MF4232	82891WS	0986MF2891		
Jeep	Grand Cherokee	8 Cil, 5.2L	1993-1998	80036WS	0986MF0036	84232WS	0986MF4232	82891WS	0986MF2891		
Jeep	Grand Cherokee	8 Cil, 5.9L	1998	80036WS	0986MF0036						
Jeep	Grand Cherokee	6 Cil, 4.0L	1999-2004	80036WS	0986MF0036	84232WS	0986MF4232				
Jeep	Grand Cherokee	8 Cil, 4.7L	1999-2004	80036WS	0986MF0036						
Jeep	Grand Cherokee	8 Cil, 5.7L	2005-2008	80036WS	0986MF0036	5927WS	0986MF4817				
Jeep	Grand Cherokee	8 Cil, 6.1L	2006-2008	80036WS	0986MF0036	5927WS	0986MF4817				
Jeep	Grand Cherokee	6 Cil, 3.7L	2005-2009	80031WS	0986MF0031	5927WS	0986MF4817				







		 									
Marca	Modelo	Motor	Año	Num. Corto	10 Dígitos	Num. Corto	10 Dígitos	Num. Corto	10 Dígitos		
Jeep	Grand Cherokee	8 Cil, 6.1L	2009-2010	80013WS	0986MF0013	5927WS	0986MF4817				
Jeep	Grand Cherokee	8 Cil, 5.7L	2017-2019	80013WS	0986MF0013	84257WS	0986MF4257				
Jeep	Grand Cherokee	6 Cil, 3.6L	2016-2021	80046WS	0986MF0046	84257WS	0986MF4257				
Jeep	Grand Cherokee	8 Cil, 6.4L	2012-2021	80029WS	0986MF0029	84257WS	0986MF4257				
Jeep	Liberty	6 Cil, 3.7L	2002-2007	80031WS	0986MF0031	5927WS	0986MF4817				
Jeep	Liberty	6 Cil, 3.7L	2008-2013	80013WS	0986MF0013	84013WS	0986MF4013				
Jeep	Patriot	4 Cil, 2.4L	2009-2010	80013WS	0986MF0013	84073WS	0986MF4073				
Jeep	Patriot	4 Cil, 2.4L	2011-2017	80013WS	0986MF0013	84030WS	0986MF4030				
Jeep	Renegade	4 Cil, 1.8L	2017-2021					82899WS	0986MF2899		
Jeep	Wrangler	4 Cil, 2.5L	1993-1995	80036WS	0986MF0036	84226WS	0986MF4226				
Jeep	Wrangler	4 Cil, 2.5L	1997-2002	80036WS	0986MF0036	84043WS	0986MF4043				
Jeep	Wrangler	4 Cil, 2.4L	2003-2006	80034WS	0986MF0034	84201WS	0986MF4201				
Jeep	Wrangler	6 Cil, 4.0L	1998-2006	80036WS	0986MF0036	84043WS	0986MF4043				
Jeep	Wrangler	6 Cil, 3.8L	2007-2011	80034WS	0986MF0034	84198WS	0986MF4198				
Jeep	Wrangler	6 Cil, 3.6L	2012-2013	80003WS	0986MF0003	84198WS	0986MF4198				
Jeep	Wrangler	6 Cil, 3.6L	2014-2018	80046WS	0986MF0046	84198WS	0986MF4198				
Kia	Forte	4 Cil, 2.0L	2016-2018	80081WS	0986MF0081	84141WS	0986MF4141				
Kia	Forte	4 Cil, 2.0L	2019-2021			84141WS	0986MF4141				
Kia	Niro	4 Cil, 1.6L	2017-2020	80081WS	0986MF0081						
Kia	Optima	4 Cil, 2.4L	2016-2019	80081WS	0986MF0081						
Kia	Optima	4 Cil, 2.0L	2016-2020	80081WS	0986MF0081						
Kia	Rio	4 Cil, 1.6L	2016-2018	80081WS	0986MF0081	84147WS	0986MF4147				
Kia	Sorento	4 Cil, 2.4L	2016-2020	80081WS	0986MF0081	84210WS	0986MF4210				
Kia	Sorento	6 Cil, 3.3L	2016-2020	80081WS	0986MF0081	84210WS	0986MF4210				
Kia	Soul	4 Cil, 2.0L	2016-2019	80081WS	0986MF0081						
Kia	Soul	4 Cil, 1.6L	2016-2021	80081WS	0986MF0081	84147WS	0986MF4147				
Kia	Sportage	4 Cil, 2.0L	2017-2021	80081WS	0986MF0081						
Kia	Sportage	4 Cil, 2.4L	2017-2021	80081WS	0986MF0081						
Kia	Stinger	4 Cil, 2.0L	2018	80081WS	0986MF0081						
Land Rover	Discovery	8 Cil, 4.0L	2000-2002			84172WS	0986MF4172				
Land Rover	Discovery	8 Cil, 4.6L	2003-2004			84172WS	0986MF4172				
Land Rover	Freelander	6 Cil, 2.5L	2002-2006			84172WS	0986MF4172				







											
Marca	Modelo	Motor	Año	Num. Corto	10 Dígitos	Num. Corto	10 Dígitos	Num. Corto	10 Dígitos		
Land Rover	Range Rover	8 Cil, 4.6L	1997-2001			84172WS	0986MF4172				
Land Rover	Range Rover	8 Cil, 4.2L	2006-2009			84220WS	0986MF4220				
Land Rover	Range Rover	8 Cil, 4.4L	2006-2009			84220WS	0986MF4220				
Land Rover	Range Rover Sport	8 Cil, 4.2L	2006-2009			84220WS	0986MF4220				
Land Rover	Range Rover Sport	8 Cil, 4.4L	2006-2009			84220WS	0986MF4220				
Lincoln	Aviator	8 Cil, 4.6L	2003-2005	80029WS	0986MF0029	84246WS	0986MF4246				
Lincoln	Blackwood	8 Cil, 5.4L	2003	80029WS	0986MF0029						
Lincoln	Continental	8 Cil, 4.6L	1997-1999	80029WS	0986MF0029			77121WS	0986MF2011		
Lincoln	Continental	6 Cil, 3.0L	2018-2020			84159WS	0986MF4159				
Lincoln	LS	8 Cil, 3.9L	2000-2002			84071WS	0986MF4071	77170WS	0986MF2133		
Lincoln	LS	6 Cil, 3.0L	2004-2005	80031WS	0986MF0031	84071WS	0986MF4071				
Lincoln	LS	8 Cil, 3.9L	2003-2006			84071WS	0986MF4071				
Lincoln	Mark LT	8 Cil, 5.4L	2006-2008	80029WS	0986MF0029	84162WS	0986MF4162	77170WS	0986MF2133		
Lincoln	Mark LT	8 Cil, 5.4L	2010	80029WS	0986MF0029						
Lincoln	Mark VIII	8 Cil, 4.6L	1995-1996	80029WS	0986MF0029						
Lincoln	MKC	4 Cil, 2.0L	2018	80034WS	0986MF0034	84032WS	0986MF4032				
Lincoln	MKC	4 Cil, 2.3L	2015-2019	80034WS	0986MF0034	84032WS	0986MF4032				
Lincoln	MKS	6 Cil, 3.7L	2009-2011			84015WS	0986MF4015				
Lincoln	MKS	6 Cil, 3.5L	2011-2014			84015WS	0986MF4015				
Lincoln	MKX	6 Cil, 3.5L	2007-2010	80031WS	0986MF0031	84015WS	0986MF4015				
Lincoln	MKX	6 Cil, 3.7L	2011-2015			84015WS	0986MF4015				
Lincoln	MKZ	6 Cil, 3.5L	2007-2009	80031WS	0986MF0031	84015WS	0986MF4015				
Lincoln	MKZ	6 Cil, 3.7L	2013-2016			84159WS	0986MF4159				
Lincoln	MKZ	4 Cil, 2.0L	2013-2020	80034WS	0986MF0034	84159WS	0986MF4159				
Lincoln	Navigator	8 Cil, 5.4L	2005-2007	80029WS	0986MF0029	84162WS	0986MF4162	77170WS	0986MF2133		
Lincoln	Navigator	8 Cil, 5.4L	2010-2014	80029WS	0986MF0029	84066WS	0986MF4066				
Lincoln	Navigator	8 Cil, 5.4L	1998-1999	80029WS	0986MF0029	5811WS	0986MF4004				
Lincoln	Navigator	8 Cil, 5.4L	2001-2004	80029WS	0986MF0029	5811WS	0986MF4004	77170WS	0986MF2133		
Lincoln	Navigator	8 Cil, 5.4L	2008-2009	80029WS	0986MF0029	84066WS	0986MF4066	77170WS	0986MF2133		
Lincoln	Navigator	6 Cil, 3.5L	2015-2021			84066WS	0986MF4066				
Lincoln	Town Car	8 Cil, 4.6L	1991-1997	80029WS	0986MF0029	5816WS	0986MF4056	77121WS	0986MF2011		
Lincoln	Town Car	8 Cil, 4.6L	1998-2007	80029WS	0986MF0029	5816WS	0986MF4056	77170WS	0986MF2133		







		 Cil.  CC				Filtro de aceite 		Filtro de aire 		Filtro de gasolina 	
Marca	Modelo	Motor	Año	Num. Corto	10 Dígitos	Num. Corto	10 Dígitos	Num. Corto	10 Dígitos	Num. Corto	10 Dígitos
Lincoln	Zephyr	6 Cil, 3.0L	2006	80029WS	0986MF0029	84016WS	0986MF4016				
Lotus	Elise	4 Cil, 1.8L	2004-2006	80028WS	0986MF0028						
Lotus	Exige	4 Cil, 1.8L	2007	80028WS	0986MF0028						
Mazda	CX-3	4 Cil, 2.0L	2016-2021	80022WS	0986MF0022	84213WS	0986MF4213				
Mazda	CX-5	4 Cil, 2.5L	2014-2018	80022WS	0986MF0022	84135WS	0986MF4135				
Mazda	CX-5	4 Cil, 2.0L	2013-2019	80022WS	0986MF0022	84135WS	0986MF4135				
Mazda	CX-7	4 Cil, 2.3L	2007-2008			5905WS	0986MF4669				
Mazda	CX-7	4 Cil, 2.3L	2009-2012	80034WS	0986MF0034	5905WS	0986MF4669				
Mazda	CX-7	4 Cil, 2.5L	2010-2012	80034WS	0986MF0034	5905WS	0986MF4669				
Mazda	CX-9	6 Cil, 3.5L	2007	80031WS	0986MF0031	84015WS	0986MF4015				
Mazda	CX-9	6 Cil, 3.7L	2008-2015	80031WS	0986MF0031	84015WS	0986MF4015				
Mazda	CX-9	4 Cil, 2.5L	2016-2021	80022WS	0986MF0022						
Mazda	Mazda 2	4 Cil, 1.5L	2012-2015	80022WS	0986MF0022	84077WS	0986MF4077				
Mazda	Mazda 2	4 Cil, 1.5L	2016-2021	80022WS	0986MF0022	84077WS	0986MF4077				
Mazda	Mazda 3	4 Cil, 2.0L	2006-2012	80034WS	0986MF0034	84078WS	0986MF4078				
Mazda	Mazda 3	4 Cil, 2.0L	2014-2018	80022WS	0986MF0022	84135WS	0986MF4135				
Mazda	Mazda 3	4 Cil, 2.3L	2006-2008			84078WS	0986MF4078				
Mazda	Mazda 3	4 Cil, 2.0L	2013	80022WS	0986MF0022	84135WS	0986MF4135				
Mazda	Mazda 3	4 Cil, 2.5L	2010-2013	80034WS	0986MF0034	84078WS	0986MF4078				
Mazda	Mazda 3	4 Cil, 2.5L	2014-2018	80022WS	0986MF0022	84135WS	0986MF4135				
Mazda	Mazda 3	4 Cil, 2.5L	2019-2021	80022WS	0986MF0022	84135WS	0986MF4135				
Mazda	Mazda 5	4 Cil, 2.5L	2012-2015	80022WS	0986MF0022						
Mazda	Mazda 6	4 Cil, 2.5L	2011-2021	80034WS	0986MF0034	84135WS	0986MF4135				
Mazda	Mazda 6	4 Cil, 2.3L	2006-2008			5905WS	0986MF4669				
Mazda	Mazda 6	6 Cil, 3.0L	2006-2008	80029WS	0986MF0029	5905WS	0986MF4669				
Mazda	Mazda 6	4 Cil, 2.5L	2009-2010			84020WS	0986MF4020				
Mazda	Mazda 6	6 Cil, 3.7L	2009-2013	80031WS	0986MF0031	84015WS	0986MF4015				
Mazda	MX-5	4 Cil, 2.0L	2006-2015	80034WS	0986MF0034						
Mazda	MX-5	4 Cil, 2.0L	2016-2021	80022WS	0986MF0022						
Mercedes-Benz	A160	4 Cil, 1.6L	2000-2005			84028WS	0986MF4028				
Mercedes-Benz	A190	4 Cil, 1.9L	2001-2005			84028WS	0986MF4028				
Mercedes-Benz	C230	4 Cil, 2.3L	1996-2000					77131WS		0986MF2030	







											
Marca	Modelo	Motor	Año	Num. Corto	10 Dígitos	Num. Corto	10 Dígitos	Num. Corto	10 Dígitos		
Mercedes-Benz	C240	6 Cil, 2.6L	2001-2002			84067WS	0986MF4067				
Mercedes-Benz	C250	6 Cil, 3.5L	2012			84175WS	0986MF4175				
Mercedes-Benz	C280	6 Cil, 2.8L	1999-2000			84174WS	0986MF4174				
Mercedes-Benz	C280	6 Cil, 3.0L	2006-2007			84067WS	0986MF4067				
Mercedes-Benz	C280	6 Cil, 3.0L	2009			84175WS	0986MF4175				
Mercedes-Benz	C300	6 Cil, 3.0L	2010-2011			84067WS	0986MF4067				
Mercedes-Benz	C300	6 Cil, 3.5L	2010-2011			84175WS	0986MF4175				
Mercedes-Benz	C32 AMG	6 Cil, 3.2L	2002-2004			84175WS	0986MF4175				
Mercedes-Benz	C320	6 Cil, 3.2L	2001-2005			84067WS	0986MF4067				
Mercedes-Benz	C350	6 Cil, 3.5L	2006-2007			84067WS	0986MF4067				
Mercedes-Benz	C350	6 Cil, 3.5L	2008-2009			84067WS	0986MF4067				
Mercedes-Benz	C350	6 Cil, 3.5L	2013-2014			84175WS	0986MF4175				
Mercedes-Benz	C350	6 Cil, 3.5L	2015			84175WS	0986MF4175				
Mercedes-Benz	C43 AMG	8 Cil, 4.3L	1998-2000					77131WS	0986MF2030		
Mercedes-Benz	C55 AMG	8 Cil, 5.4L	2005-2007			84067WS	0986MF4067				
Mercedes-Benz	CL500	8 Cil, 5.5L	2007-2009			84067WS	0986MF4067				
Mercedes-Benz	CL500	8 Cil, 5.5L	2010-2012			84175WS	0986MF4175				
Mercedes-Benz	CL600	12 Cil, 5.5L	2003-2006					77131WS	0986MF2030		
Mercedes-Benz	CLK280	6 Cil, 3.0L	2007-2009			84067WS	0986MF4067				
Mercedes-Benz	CLK320	6 Cil, 3.2L	1997-2003			84174WS	0986MF4174				
Mercedes-Benz	CLK320	6 Cil, 3.2L	1998-2003			84174WS	0986MF4174				
Mercedes-Benz	CLK320	6 Cil, 3.2L	2004-2005			84174WS	0986MF4174				
Mercedes-Benz	CLK350	6 Cil, 3.5L	2006-2009			84067WS	0986MF4067				
Mercedes-Benz	CLK500	8 Cil, 5.0L	2003-2005			84067WS	0986MF4067				
Mercedes-Benz	CLK500	8 Cil, 5.0L	2006			84175WS	0986MF4175				
Mercedes-Benz	CLK500	8 Cil, 5.5L	2007-2009			84175WS	0986MF4175				
Mercedes-Benz	CLS350	6 Cil, 3.5L	2007-2009			84067WS	0986MF4067				
Mercedes-Benz	CLS500	8 Cil, 5.0L	2005-2006			84067WS	0986MF4067				
Mercedes-Benz	E250	6 Cil, 3.5L	2011-2012			84175WS	0986MF4175				
Mercedes-Benz	E250	8 Cil, 5.5L	2011-2012			84175WS	0986MF4175				
Mercedes-Benz	E280	6 Cil, 3.0L	2007-2009			84067WS	0986MF4067				
Mercedes-Benz	E300	6 Cil, 3.0L	2010			84175WS	0986MF4175				







		 Cil.  CC			Filtro de aceite 	Filtro de aire 	Filtro de gasolina 			
Marca	Modelo	Motor	Año		Num. Corto	10 Dígitos	Num. Corto	10 Dígitos	Num. Corto	10 Dígitos
Mercedes-Benz	E300	6 Cil, 3.0L	2010-2011				84175WS	0986MF4175		
Mercedes-Benz	E320	6 Cil, 3.2L	1996						77131WS	0986MF2030
Mercedes-Benz	E320	6 Cil, 3.2L	1999-2003				84067WS	0986MF4067		
Mercedes-Benz	E320	6 Cil, 3.2L	2004-2005				84067WS	0986MF4067		
Mercedes-Benz	E350	6 Cil, 3.5L	2006-2009				84175WS	0986MF4175		
Mercedes-Benz	E350	6 Cil, 3.5L	2010-2011				84175WS	0986MF4175		
Mercedes-Benz	E500	8 Cil, 5.0L	2002-2006				84175WS	0986MF4175		
Mercedes-Benz	G500	8 Cil, 5.0L	2002-2008				84175WS	0986MF4175		
Mercedes-Benz	G500	8 Cil, 5.5L	2009-2015				84175WS	0986MF4175		
Mercedes-Benz	GLK300	6 Cil, 3.0L	2010-2012				84175WS	0986MF4175		
Mercedes-Benz	GLK300	6 Cil, 3.5L	2012-2014				84175WS	0986MF4175		
Mercedes-Benz	GLK300	6 Cil, 3.5L	2015				84175WS	0986MF4175		
Mercedes-Benz	ML320	6 Cil, 3.2L	1998-2002				84174WS	0986MF4174		
Mercedes-Benz	ML350	6 Cil, 3.7L	2003-2005				84174WS	0986MF4174		
Mercedes-Benz	ML350	6 Cil, 3.5L	2006-2011				84175WS	0986MF4175		
Mercedes-Benz	ML430	8 Cil, 4.3L	1998				84174WS	0986MF4174		
Mercedes-Benz	ML430	8 Cil, 4.3L	1999-2001				84174WS	0986MF4174		
Mercedes-Benz	ML500	8 Cil, 5.0L	2002-2005				84174WS	0986MF4174		
Mercedes-Benz	ML500	8 Cil, 5.0L	2006-2007				84175WS	0986MF4175		
Mercedes-Benz	ML500	8 Cil, 5.5L	2008-2011				84175WS	0986MF4175		
Mercedes-Benz	ML55 AMG	8 Cil, 5.4L	2001-2003				84174WS	0986MF4174		
Mercedes-Benz	R350	6 Cil, 3.5L	2008-2012				84175WS	0986MF4175		
Mercedes-Benz	R350	6 Cil, 3.5L	2013				84175WS	0986MF4175		
Mercedes-Benz	R500	8 Cil, 5.0L	2006-2007				84175WS	0986MF4175		
Mercedes-Benz	S430	8 Cil, 4.3L	1999-2005				84175WS	0986MF4175	77131WS	0986MF2030
Mercedes-Benz	S500	8 Cil, 5.0L	1999-2006				84175WS	0986MF4175		
Mercedes-Benz	S500	8 Cil, 5.5L	2007-2011				84175WS	0986MF4175		
Mercedes-Benz	S600	12 Cil, 6.0L	2000						77131WS	0986MF2030
Mercedes-Benz	S600	12 Cil, 5.5L	2003-2006						77131WS	0986MF2030
Mercedes-Benz	SL500	8 Cil, 5.0L	1996						77131WS	0986MF2030
Mercedes-Benz	SL500	8 Cil, 5.0L	1996-2002				84175WS	0986MF4175	77131WS	0986MF2030
Mercedes-Benz	SL500	8 Cil, 5.0L	2003-2006				84175WS	0986MF4175	77131WS	0986MF2030







											
Marca	Modelo	Motor	Año	Num. Corto	10 Dígitos	Num. Corto	10 Dígitos	Num. Corto	10 Dígitos		
Mercedes-Benz	SL500	8 Cil, 5.5L	2007-2012			84175WS	0986MF4175	77131WS	0986MF2030		
Mercedes-Benz	SL60 AMG	8 Cil, 6.0L	1997-1998					77131WS	0986MF2030		
Mercedes-Benz	SL600	12 Cil, 6.0L	1996-1998					77131WS	0986MF2030		
Mercedes-Benz	SL600	12 Cil, 6.0L	1999-2002					77131WS	0986MF2030		
Mercedes-Benz	SL600	12 Cil, 5.5L	2003-2006					77131WS	0986MF2030		
Mercedes-Benz	SL600	12 Cil, 5.5L	2007-2012					77131WS	0986MF2030		
Mercedes-Benz	SL65 AMG	12 Cil, 6.0L	2005-2012					77131WS	0986MF2030		
Mercedes-Benz	SLK200	6 Cil, 3.5L	2010-2012			84175WS	0986MF4175				
Mercedes-Benz	SLK350	6 Cil, 3.5L	2005-2008			84175WS	0986MF4175				
Mercedes-Benz	SLK55 AMG	8 Cil, 5.5L	2005-2011			84175WS	0986MF4175				
Mercedes-Benz	SLR McLaren	8 Cil, 5.4L	2007-2008			84174WS	0986MF4174				
Mercedes-Benz	SLS AMG	8 Cil, 6.2L	2011-2014			84225WS	0986MF4225				
Mercedes-Benz	Sprinter	5 Cil, 2.7L	2004			5894WS	0986MF4604				
Mercedes-Benz	Sprinter	5 Cil, 2.7L	2005-2006			84204WS	0986MF4204				
Mercury	Mariner	6 Cil, 3.0L	2005-2008	80029WS	0986MF0029						
Mercury	Mariner	6 Cil, 3.0L	2009-2011			84031WS	0986MF4031	77124WS	0986MF2018		
Mercury	Milan	6 Cil, 3.0L	2007-2008	80029WS	0986MF0029	84016WS	0986MF4016	77170WS	0986MF2133		
Mercury	Montego	6 Cil, 3.0L	2005-2007	80029WS	0986MF0029	84256WS	0986MF4256	77170WS	0986MF2133		
Mercury	Sable	6 Cil, 3.0L	2002-2004	80031WS	0986MF0031						
Mini	Cooper	4 Cil, 1.6L	2007-2016	80001WS	0986MF0001	84202WS	0986MF4202				
Mini	Cooper Countryman	4 Cil, 1.6L	2011-2014	80001WS	0986MF0001	84202WS	0986MF4202				
Mini	Cooper Paceman	4 Cil, 1.6L	2013-2016	80001WS	0986MF0001	84202WS	0986MF4202				
Mitsubishi	ASX	4 Cil, 2.0L	2013-2015	72273WS	F00E164931						
Mitsubishi	Eclipse	6 Cil, 3.0L	2003-2005	80081WS	0986MF0081	5843WS	0986MF4344				
Mitsubishi	Eclipse	6 Cil, 3.8L	2006-2012	72273WS	F00E164931						
Mitsubishi	Endeavor	6 Cil, 3.8L	2004-2011	72273WS	F00E164931						
Mitsubishi	Galant	6 Cil, 3.0L	2003	80081WS	0986MF0081	5843WS	0986MF4344				
Mitsubishi	Galant	6 Cil, 3.8L	2004-2007	72273WS	F00E164931						
Mitsubishi	Galant	4 Cil, 2.4L	2004-2009	72273WS	F00E164931						
Mitsubishi	Grandis	4 Cil, 2.4L	2007-2009	80081WS	0986MF0081						
Mitsubishi	L200	4 Cil, 2.4L	2010-2016	72273WS	F00E164931	84079WS	0986MF4079				







		 									
Marca	Modelo	Motor	Año	Num. Corto	10 Dígitos	Num. Corto	10 Dígitos	Num. Corto	10 Dígitos		
Mitsubishi	L200	4 Cil, 2.4L	2008-2021	72273WS	F00E164931	84079WS	0986MF4079				
Mitsubishi	L200 - Diesel	4 Cil, 2.5L	2008-2014	72285WS	0986MF0240	84079WS	0986MF4079				
Mitsubishi	L200 - Diesel	4 Cil, 2.5L	2015-2020	72285WS	0986MF0240	84079WS	0986MF4079				
Mitsubishi	Lancer	4 Cil, 2.0L	2005-2016	72273WS	F00E164931	84083WS	0986MF4083				
Mitsubishi	Lancer	4 Cil, 2.4L	2009-2016	72273WS	F00E164931	84083WS	0986MF4083				
Mitsubishi	Mirage	3 Cil, 1.2L	2015-2020	72273WS	F00E164931	84137WS	0986MF4137				
Mitsubishi	Montero	6 Cil, 3.8L	2003-2006	80081WS	0986MF0081						
Mitsubishi	Montero	6 Cil, 3.8L	2008-2019	80081WS	0986MF0081						
Mitsubishi	Montero Sport	6 Cil, 3.5L	2003-2005	80081WS	0986MF0081	84081WS	0986MF4081				
Mitsubishi	Montero Sport	6 Cil, 3.5L	2006-2008	72273WS	F00E164931	84081WS	0986MF4081				
Mitsubishi	Montero Sport	6 Cil, 3.5L	2009-2011	72273WS	F00E164931						
Mitsubishi	Montero Sport	6 Cil, 3.0L	2012-2015	72273WS	F00E164931						
Mitsubishi	Outlander	4 Cil, 2.4L	2008-2013	72273WS	F00E164931	84083WS	0986MF4083				
Mitsubishi	Outlander	4 Cil, 2.4L	2014-2020	72273WS	F00E164931						
Nissan	240SX	4 Cil, 2.4L	1993	80027WS	0986MF0027	5841WS	0986MF4309	77213WS	0986MF2309		
Nissan	300ZX	6 Cil, 3.0L	1991-1996	80027WS	0986MF0027	84214WS	0986MF4214	77143WS	0986MF2047		
Nissan	350Z	6 Cil, 3.5L	2003-2008	80022WS	0986MF0022	5841WS	0986MF4309				
Nissan	370Z	6 Cil, 3.7L	2009-2019	80022WS	0986MF0022						
Nissan	Almera	4 Cil, 1.8L	2001-2005	80022WS	0986MF0022	5841WS	0986MF4309	82902WS	0986MF2902		
Nissan	Altima	6 Cil, 3.5L	2008-2018	80022WS	0986MF0022	5841WS	0986MF4309				
Nissan	Altima	4 Cil, 2.4L	1996-1997	80027WS	0986MF0027	5841WS	0986MF4309	82902WS	0986MF2902		
Nissan	Altima	4 Cil, 2.4L	1998-2001	72273WS	F00E164931	5841WS	0986MF4309	82902WS	0986MF2902		
Nissan	Altima	4 Cil, 2.5L	2002-2006	80022WS	0986MF0022	5841WS	0986MF4309	82902WS	0986MF2902		
Nissan	Altima	6 Cil, 3.5L	2002-2006	80022WS	0986MF0022	5841WS	0986MF4309	82902WS	0986MF2902		
Nissan	Altima	4 Cil, 2.5L	2007-2012	80022WS	0986MF0022	84014WS	0986MF4014				
Nissan	Altima	4 Cil, 2.5L	2013-2018	80022WS	0986MF0022	84148WS	0986MF4148				
Nissan	Aprio	4 Cil, 1.6L	2008-2010	80026WS	0986MF0026	84173WS	0986MF4173*	82426WS	0986MF2426		
Nissan	Armada	8 Cil, 5.6L	2005-2015	72273WS	F00E164931	84232WS	0986MF4232				
Nissan	Armada	8 Cil, 5.6L	2017-2020	72273WS	F00E164931	84232WS	0986MF4232				
Nissan	Cabstar - Diesel	4 Cil, 2.5L	2008-2016	80012WS	0986MF0012	84093WS	0986MF4093				
Nissan	Frontier	6 Cil, 3.3L	2001-2004	72273WS	F00E164931	5841WS	0986MF4309	77213WS	0986MF2309		
Nissan	Frontier	4 Cil, 2.4L	2001-2008	72273WS	F00E164931	84091WS	0986MF4091	77213WS	0986MF2309		







											
Marca	Modelo	Motor	Año	Num. Corto	10 Dígitos	Num. Corto	10 Dígitos	Num. Corto	10 Dígitos		
Nissan	Frontier	4 Cil, 2.4L	2011-2015	72273WS	F00E164931	84091WS	0986MF4091				
Nissan	Frontier	6 Cil, 4.0L	2008-2020	72273WS	F00E164931	84232WS	0986MF4232	77213WS	0986MF2309		
Nissan	GT-R	6 Cil, 3.8L	2017-2020	72273WS	F00E164931						
Nissan	Hikari	4 Cil, 1.6L	1988-1992	80027WS	0986MF0027	5841WS	0986MF4309	77132WS	0986MF2032		
Nissan	Ichi Van	4 Cil, 1.8L	1987-1992	80020WS	0986MF0020	5841WS	0986MF4309	77132WS	0986MF2032		
Nissan	Ichi Van	4 Cil, 2.4L	1992-1994	80027WS	0986MF0027	5841WS	0986MF4309	77132WS	0986MF2032		
Nissan	Juke	4 Cil, 1.6L	2012-2017	80022WS	0986MF0022	84214WS	0986MF4214				
Nissan	Kicks	4 Cil, 1.6L	2017-2020	80022WS	0986MF0022	84217WS	0986MF4217				
Nissan	Lucino	4 Cil, 2.0L	1996-1999	80022WS	0986MF0022	5841WS	0986MF4309	77213WS	0986MF2309		
Nissan	Lucino	4 Cil, 1.6L	1996-1999	80027WS	0986MF0027	5841WS	0986MF4309	77213WS	0986MF2309		
Nissan	Lucino	4 Cil, 1.6L	2000	80027WS	0986MF0027	84214WS	0986MF4214	82902WS	0986MF2902		
Nissan	Lucino	4 Cil, 2.0L	2000	80022WS	0986MF0022	5823WS	0986MF4100	77213WS	0986MF2309		
Nissan	March	4 Cil, 1.6L	2012-2020	80022WS	0986MF0022	84092WS	0986MF4092				
Nissan	Maxima	6 Cil, 3.0L	1991-1993	80027WS	0986MF0027	5841WS	0986MF4309	77213WS	0986MF2309		
Nissan	Maxima	6 Cil, 3.0L	1995-2001	72273WS	F00E164931	5841WS	0986MF4309	77213WS	0986MF2309		
Nissan	Maxima	6 Cil, 3.5L	2002-2008	80022WS	0986MF0022	5841WS	0986MF4309	77213WS	0986MF2309		
Nissan	Maxima	6 Cil, 3.5L	2009-2020	80022WS	0986MF0022	5841WS	0986MF4309				
Nissan	Micra	4 Cil, 1.4L	2005-2007	80028WS	0986MF0028	84259WS	0986MF4259				
Nissan	Murano	6 Cil, 3.5L	2004-2008	80022WS	0986MF0022	5841WS	0986MF4309				
Nissan	Murano	6 Cil, 3.5L	2009-2019	80022WS	0986MF0022	5841WS	0986MF4309				
Nissan	Note	4 Cil, 1.6L	2014-2019	80022WS	0986MF0022	84092WS	0986MF4092				
Nissan	NP300	4 Cil, 2.4L	2009-2015	72273WS	F00E164931	84091WS	0986MF4091				
Nissan	NP300	4 Cil, 2.5L	2016-2021	72273WS	F00E164931	84216WS	0986MF4216				
Nissan	NP300 - Diesel	4 Cil, 2.5L	2014-2017	80022WS	0986MF0022	84216WS	0986MF4216				
Nissan	NP300 Frontier	4 Cil, 2.5L	2016-2020	72273WS	F00E164931	84216WS	0986MF4216				
Nissan	NV2500	8 Cil, 5.6L	2013	72273WS	F00E164931	84232WS	0986MF4232				
Nissan	NV2500	6 Cil, 4.0L	2013-2015	72273WS	F00E164931	84232WS	0986MF4232				
Nissan	NV350 Urvan	4 Cil, 2.5L	2014-2021	72273WS	F00E164931	84094WS	0986MF4094				
Nissan	NV350 Urvan Diesel	4 Cil, 2.5L	2014-2020	80012WS	0986MF0012	84094WS	0986MF4094				
Nissan	Pathfinder	6 Cil, 3.3L	1997-2000	72273WS	F00E164931	5841WS	0986MF4309	82902WS	0986MF2902		
Nissan	Pathfinder	6 Cil, 3.5L	2001-2004	72273WS	F00E164931	5841WS	0986MF4309	77213WS	0986MF2309		
Nissan	Pathfinder	6 Cil, 4.0L	2005-2012	72273WS	F00E164931	84232WS	0986MF4232				







		 Cil.  CC				Filtro de aceite 		Filtro de aire 		Filtro de gasolina 	
Marca	Modelo	Motor	Año	Num. Corto	10 Dígitos	Num. Corto	10 Dígitos	Num. Corto	10 Dígitos	Num. Corto	10 Dígitos
Nissan	Pathfinder	6 Cil, 3.5L	2013-2020	80022WS	0986MF0022	5841WS	0986MF4309				
Nissan	Pathfinder Armada	8 Cil, 5.6L	2004	72273WS	F00E164931	84232WS	0986MF4232				
Nissan	Pickup	4 Cil, 2.4L	1998-2010	72273WS	F00E164931			82902WS		0986MF2902	
Nissan	Pickup	4 Cil, 1.8L	1984-1992			84236WS	0986MF4236				
Nissan	Pickup	4 Cil, 2.4L	1993-1994	80027WS	0986MF0027	84091WS	0986MF4091	82902WS		0986MF2902	
Nissan	Pickup	4 Cil, 2.4L	1995-1997	80027WS	0986MF0027			82902WS		0986MF2902	
Nissan	Pickup	4 Cil, 2.5L	2010	72273WS	F00E164931	84233WS	0986MF4233				
Nissan	Platina	4 Cil, 1.6L	2002-2010	80026WS	0986MF0026	84229WS / 84173WS*	0986MF4229 / 0986MF4173*	82426WS		0986MF2426	
Nissan	Quest	6 Cil, 3.0L	1997-1998	80027WS	0986MF0027			77143WS		0986MF2047	
Nissan	Quest	6 Cil, 3.3L	1999-2002	72273WS	F00E164931			77213WS		0986MF2309	
Nissan	Rogue	4 Cil, 2.5L	2008-2014	80022WS	0986MF0022	5823WS	0986MF4100				
Nissan	Sakura	4 Cil, 1.8L	1984-1986	80020WS	0986MF0020	5829WS	0986MF4189				
Nissan	Samurai	4 Cil, 1.5L	1985	80027WS	0986MF0027						
Nissan	Samurai	4 Cil, 1.6L	1986-1987	80027WS	0986MF0027						
Nissan	Sentra	4 Cil, 1.6L	1996-2000	80027WS	0986MF0027	5841WS	0986MF4309	77213WS		0986MF2309	
Nissan	Sentra	4 Cil, 2.0L	1996-2001	80022WS	0986MF0022	5841WS	0986MF4309	77213WS		0986MF2309	
Nissan	Sentra	4 Cil, 2.0L	2000-2001	80022WS	0986MF0022	5841WS	0986MF4309	82902WS		0986MF2902	
Nissan	Sentra	4 Cil, 1.8L	2001-2006	72273WS	F00E164931	5841WS	0986MF4309	82902WS		0986MF2902	
Nissan	Sentra	4 Cil, 2.5L	2002-2006	72273WS	F00E164931	5841WS	0986MF4309	82902WS		0986MF2902	
Nissan	Sentra	4 Cil, 2.0L	2007-2012	80022WS	0986MF0022	0986MF4042	0986MF4042				
Nissan	Sentra	4 Cil, 2.5L	2007-2012	80022WS	0986MF0022	84214WS	0986MF4214				
Nissan	Sentra	4 Cil, 1.6L	2018-2019	80022WS	0986MF0022	84214WS	0986MF4214				
Nissan	Sentra	4 Cil, 1.8L	2013-2019	80022WS	0986MF0022	84214WS	0986MF4214				
Nissan	Tiida	4 Cil, 1.8L	2007-2018	80022WS	0986MF0022	84090WS	0986MF4090				
Nissan	Tiida	4 Cil, 1.6L	2013-2018	80022WS	0986MF0022	84092WS	0986MF4092				
Nissan	Titan	8 Cil, 5.6L	2004-2015	72273WS	F00E164931	84232WS	0986MF4232				
Nissan	Tsubame	4 Cil, 1.6L	1993-2004	80027WS	0986MF0027	5841WS	0986MF4309	77213WS		0986MF2309	
Nissan	Tsuru	4 Cil, 1.5L	1984-1985	80027WS	0986MF0027	84236WS	0986MF4236	77132WS		0986MF2032	
Nissan	Tsuru	4 Cil, 1.6L	1986-1988	80027WS	0986MF0027	84236WS	0986MF4236	77132WS		0986MF2032	
Nissan	Tsuru	4 Cil, 1.6L	1989-1990	80027WS	0986MF0027	84236WS	0986MF4236				
Nissan	Tsuru	4 Cil, 1.6L	1989-1991	80027WS	0986MF0027	84236WS	0986MF4236				







											
Marca	Modelo	Motor	Año	Num. Corto	10 Dígitos	Num. Corto	10 Dígitos	Num. Corto	10 Dígitos		
Nissan	Tsuru	4 Cil, 1.6L	1991	80027WS	0986MF0027	84236WS	0986MF4236				
Nissan	Tsuru	4 Cil, 1.6L	1992	80027WS	0986MF0027			77213WS	0986MF2309		
Nissan	Tsuru	4 Cil, 1.6L	1992			84251WS	0986MF4251				
Nissan	Tsuru	4 Cil, 1.6L	1995	80027WS	0986MF0027	5841WS	0986MF4309	77213WS	0986MF2309		
Nissan	Tsuru	4 Cil, 1.6L	1995-1996			84214WS	0986MF4214				
Nissan	Tsuru	4 Cil, 2.0L	1995-1996	80027WS	0986MF0027	5841WS	0986MF4309	77213WS	0986MF2309		
Nissan	Tsuru	4 Cil, 1.6L	1996-2008	80027WS	0986MF0027	5823WS	0986MF4100	77213WS	0986MF2309		
Nissan	Tsuru	4 Cil, 1.6L	2009-2017	80028WS	0986MF0028	5823WS	0986MF4100	77213WS	0986MF2309		
Nissan	Urvan	4 Cil, 2.4L	2002-2004	72273WS	F00E164931	84215WS	0986MF4215	77213WS	0986MF2309		
Nissan	Urvan	4 Cil, 2.5L	2008-2013	72273WS	F00E164931	84094WS	0986MF4094				
Nissan	Urvan	4 Cil, 2.4L	2005-2007	72273WS	F00E164931	84231WS	0986MF4231	77213WS	0986MF2309		
Nissan	Urvan	4 Cil, 2.4L	2008	72273WS	F00E164931	84231WS	0986MF4231				
Nissan	Urvan	4 Cil, 3.0L	2008-2012			84094WS	0986MF4094				
Nissan	Versa	4 Cil, 1.6L	2009	80022WS	0986MF0022	84090WS	0986MF4090				
Nissan	Versa	4 Cil, 1.8L	2007-2009	80022WS	0986MF0022	84090WS	0986MF4090				
Nissan	Versa	4 Cil, 1.6L	2012-2019	80022WS	0986MF0022	84092WS	0986MF4092				
Nissan	Xterra	6 Cil, 3.3L	2000-2004	72273WS	F00E164931	5841WS	0986MF4309				
Nissan	Xterra	6 Cil, 4.0L	2005-2007	72273WS	F00E164931	84232WS	0986MF4232				
Nissan	X-Trail	4 Cil, 2.5L	2002-2010	72273WS	F00E164931	5841WS	0986MF4309				
Nissan	X-Trail	4 Cil, 2.5L	2015-2020	80022WS	0986MF0022	84136WS	0986MF4136				
Nissan	X-Trail	4 Cil, 2.5L	2011-2014	80022WS	0986MF0022	5823WS	0986MF4100				
Nissan	X-Trail	4 Cil, 2.0L	2018-2020	80022WS	0986MF0022	84136WS	0986MF4136				
Oldsmobile	Cutlass	6 Cil, 2.8L	1987-1989	80043WS	0986MF0043						
Oldsmobile	Cutlass	6 Cil, 3.1L	1987-1993	80043WS	0986MF0043	84262WS	0986MF4262				
Oldsmobile	Cutlass	6 Cil, 3.1L	1994-1996	80039WS	0986MF0039	5833WS	0986MF4005				
Oldsmobile	Silhouette	6 Cil, 3.1L	1991-1993	80043WS	0986MF0043						
Oldsmobile	Silhouette	6 Cil, 3.8L	1994-1995	80039WS	0986MF0039	5935WS	0986MF4916				
Peugeot	2008	4 Cil, 1.6L	2014-2016	80001WS	0986MF0001			82426WS	0986MF2426		
Peugeot	206	4 Cil, 1.4L	2000-2002	80016WS	0986MF0016	5857WS	0986MF4010	82426WS	0986MF2426		
Peugeot	206	4 Cil, 1.6L	2001-2008	80001WS	0986MF0001	5857WS	0986MF4010	82426WS	0986MF2426		
Peugeot	206	4 Cil, 1.4L	2003-2009	80001WS	0986MF0001	5857WS	0986MF4010	82426WS	0986MF2426		
Peugeot	206	4 Cil, 1.6L	2009	80001WS	0986MF0001	84026WS	0986MF4026	82426WS	0986MF2426		







				Filtro de aceite 		Filtro de aire 		Filtro de gasolina 	
				Num. Corto	10 Dígitos	Num. Corto	10 Dígitos	Num. Corto	10 Dígitos
Marca	Modelo	Motor	Año	Num. Corto	10 Dígitos	Num. Corto	10 Dígitos	Num. Corto	10 Dígitos
Peugeot	207	4 Cil, 1.6L	2008-2010					82426WS	0986MF2426
Peugeot	207	4 Cil, 1.6L	2011-2013	80001WS	0986MF0001	84027WS	0986MF4027		
Peugeot	207	4 Cil, 1.6L	2014	80001WS	0986MF0001				
Peugeot	208	4 Cil, 1.6L	2014-2016	80001WS	0986MF0001			82426WS	0986MF2426
Peugeot	208	4 Cil, 1.6L	2016-2018			84155WS	0986MF4155		
Peugeot	208	4 Cil, 1.6L	2017-2018	80001WS	0986MF0001				
Peugeot	208 GT	4 Cil, 1.6L	2014-2018	80001WS	0986MF0001	84202WS	0986MF4202	82426WS	0986MF2426
Peugeot	3008	4 Cil, 1.6L	2011-2016	80001WS	0986MF0001			82426WS	0986MF2426
Peugeot	301	4 Cil, 1.6L	2018-2019	80001WS	0986MF0001	84155WS	0986MF4155		
Peugeot	301	4 Cil, 1.6L	2015-2016			84155WS	0986MF4155		
Peugeot	306	4 Cil, 1.6L	1997					82426WS	0986MF2426
Peugeot	306	4 Cil, 1.8L	1998-2002	80016WS	0986MF0016	5840WS	0986MF4306	82426WS	0986MF2426
Peugeot	306	4 Cil, 1.8L	2001-2002	80016WS	0986MF0016	5840WS	0986MF4306	82426WS	0986MF2426
Peugeot	306	4 Cil, 2.0L	2001-2002	80016WS	0986MF0016				
Peugeot	307	4 Cil, 2.0L	2003-2009					82426WS	0986MF2426
Peugeot	307	4 Cil, 2.0L	2007-2010	80001WS	0986MF0001			82426WS	0986MF2426
Peugeot	308	4 Cil, 1.6L	2009-2010	80001WS	0986MF0001	84202WS	0986MF4202		
Peugeot	308	4 Cil, 1.6L	2011-2013	80001WS	0986MF0001	84202WS	0986MF4202		
Peugeot	308	4 Cil, 1.6L	2016-2017	80001WS	0986MF0001				
Peugeot	405	4 Cil, 2.0L	1997-1999			5830WS	0986MF4206	77131WS	0986MF2030
Peugeot	406	4 Cil, 2.0L	2000-2005	80016WS	0986MF0016			82426WS	0986MF2426
Peugeot	406	6 Cil, 3.0L	2001-2005					82426WS	0986MF2426
Peugeot	508	4 Cil, 1.6L	2012-2017	80001WS	0986MF0001	84202WS	0986MF4202	82426WS	0986MF2426
Peugeot	Expert - Diesel	4 Cil, 2.0L	2008-2009	80001WS	0986MF0001				
Peugeot	Grand Raid	4 Cil, 1.6L	2008-2012	80001WS	0986MF0001	84029WS	0986MF4029		
Peugeot	Manager - Diesel	4 Cil, 2.2L	2011-2017	80001WS	0986MF0001				
Peugeot	Partner	4 Cil, 1.6L	2013-2021			84155WS	0986MF4155		
Peugeot	Partner	4 Cil, 1.6L	2003					82426WS	0986MF2426
Peugeot	Partner	4 Cil, 1.6L	2004-2012	80001WS	0986MF0001	5869WS	0986MF4444	82426WS	0986MF2426
Peugeot	RCZ	4 Cil, 1.6L	2011-2016	80001WS	0986MF0001	84202WS	0986MF4202		
Pontiac	Aztek	6 Cil, 3.4L	2001-2005	80039WS	0986MF0039	5889WS	0986MF4597		
Pontiac	Bonneville	6 Cil, 3.8L	1995-1999	80039WS	0986MF0039	5920WS	0986MF4754	77130WS	0986MF2026







											
Marca	Modelo	Motor	Año	Num. Corto	10 Dígitos	Num. Corto	10 Dígitos	Num. Corto	10 Dígitos		
Pontiac	Firebird	8 Cil, 5.7L	1994-1997	80041WS	0986MF0041	84261WS	0986MF4261	77130WS	0986MF2026		
Pontiac	Firebird	8 Cil, 5.7L	1998-1999	80030WS	0986MF0030	84261WS	0986MF4261	77130WS	0986MF2026		
Pontiac	Firebird	8 Cil, 5.7L	2000-2001	80030WS	0986MF0030	84261WS	0986MF4261	77130WS	0986MF2026		
Pontiac	G3	4 Cil, 1.6L	2007-2009	80039WS	0986MF0039	84228WS	0986MF4228				
Pontiac	G4	4 Cil, 2.2L	2005-2006	80021WS	0986MF0021						
Pontiac	G4	4 Cil, 2.4L	2006	80021WS	0986MF0021						
Pontiac	G5	4 Cil, 2.4L	2007-2008	80021WS	0986MF0021						
Pontiac	G5	4 Cil, 2.2L	2009	80021WS	0986MF0021						
Pontiac	G6	6 Cil, 3.5L	2005-2006	80039WS	0986MF0039						
Pontiac	G6	6 Cil, 3.5L	2007-2009	80037WS	0986MF0037						
Pontiac	G6	6 Cil, 3.6L	2007-2009	80013WS	0986MF0013	84195WS	0986MF4195				
Pontiac	Grand Am	6 Cil, 3.4L	1999-2004	80039WS	0986MF0039	5832WS	0986MF4221	77130WS	0986MF2026		
Pontiac	Grand Prix	6 Cil, 3.1L	1997-1998	80039WS	0986MF0039	5889WS	0986MF4597	77130WS	0986MF2026		
Pontiac	Grand Prix	6 Cil, 3.8L	1997-2001	80039WS	0986MF0039	5889WS	0986MF4597	77130WS	0986MF2026		
Pontiac	Matiz	4 Cil, 1.0L	2004-2005	80011WS	0986MF0011			82899WS	0986MF2899		
Pontiac	Matiz	4 Cil, 1.0L	2006-2010	80011WS	0986MF0011			82899WS	0986MF2899		
Pontiac	Montana	6 Cil, 3.5L	2005-2006	80039WS	0986MF0039	5889WS	0986MF4597				
Pontiac	Montana	6 Cil, 3.9L	2007-2009	80037WS	0986MF0037						
Pontiac	Solstice	4 Cil, 2.4L	2006-2008	80021WS	0986MF0021						
Pontiac	Sunfire	4 Cil, 2.4L	1997-1999	80030WS	0986MF0030	5935WS	0986MF4916	77130WS	0986MF2026		
Pontiac	Sunfire	4 Cil, 2.4L	2000-2001	80030WS	0986MF0030	5935WS	0986MF4916	77130WS	0986MF2026		
Pontiac	Sunfire	4 Cil, 2.4L	2000-2002	80030WS	0986MF0030	5935WS	0986MF4916	77130WS	0986MF2026		
Pontiac	Sunfire	4 Cil, 2.2L	2004-2005	80021WS	0986MF0021	5935WS	0986MF4916	77130WS	0986MF2026		
Pontiac	Torrent	6 Cil, 3.4L	2006-2008	80039WS	0986MF0039	84195WS	0986MF4195				
Porsche	Boxster	6 Cil, 2.7L	2005-2006			84220WS	0986MF4220				
Porsche	Boxster	6 Cil, 3.2L	2005-2006			84220WS	0986MF4220				
Porsche	Boxster	6 Cil, 2.7L	2007-2008			84220WS	0986MF4220				
Porsche	Boxster	6 Cil, 3.4L	2007-2008			84220WS	0986MF4220				
Porsche	Boxster	6 Cil, 2.9L	2010-2012			84220WS	0986MF4220				
Porsche	Boxster	6 Cil, 3.4L	2010-2012			84220WS	0986MF4220				
Porsche	Boxster	6 Cil, 3.4L	2012-2016			84220WS	0986MF4220				
Porsche	Cayenne	6 Cil, 3.2L	2004-2006			84220WS	0986MF4220				







		 									
Marca	Modelo	Motor	Año	Num. Corto	10 Dígitos	Num. Corto	10 Dígitos	Num. Corto	10 Dígitos		
Porsche	Cayenne	8 Cil, 4.5L	2003-2006			84220WS	0986MF4220				
Porsche	Cayenne	8 Cil, 4.8L	2008-2010			84220WS	0986MF4220				
Porsche	Cayenne	8 Cil, 4.8L	2011-2014			84220WS	0986MF4220				
Porsche	Cayenne	8 Cil, 4.8L	2013-2014			84220WS	0986MF4220				
Porsche	Cayenne	6 Cil, 3.0L	2012-2018			84220WS	0986MF4220				
Porsche	Cayenne	8 Cil, 4.8L	2015-2018			84220WS	0986MF4220				
Porsche	Cayenne	6 Cil, 3.0L	2012-2019			84220WS	0986MF4220				
Porsche	Cayman	6 Cil, 2.7L	2007-2008			84220WS	0986MF4220				
Porsche	Cayman	6 Cil, 3.4L	2006-2008			84220WS	0986MF4220				
Porsche	Cayman	6 Cil, 3.4L	2009-2011			84220WS	0986MF4220				
Porsche	Cayman	6 Cil, 2.9L	2009-2012			84220WS	0986MF4220				
Porsche	Cayman	6 Cil, 2.7L	2014-2016			84220WS	0986MF4220				
Porsche	Cayman	6 Cil, 3.4L	2014-2016			84220WS	0986MF4220				
Ram	1500	8 Cil, 5.7L	2013	80013WS	0986MF0013						
Ram	1500	6 Cil, 3.6L	2014-2021			5860WS	0986MF4404				
Ram	2500	8 Cil, 4.7L	2010	80029WS	0986MF0029						
Ram	2500	8 Cil, 5.7L	2011-2013	80029WS	0986MF0029	5860WS	0986MF4404				
Ram	2500	8 Cil, 5.7L	2014-2016	80013WS	0986MF0013	5860WS	0986MF4404				
Ram	2500	8 Cil, 5.7L	2011-2017	80013WS	0986MF0013	5860WS	0986MF4404				
Ram	2500	8 Cil, 5.7L	2017-2019	80013WS	0986MF0013	5860WS	0986MF4404				
Ram	2500	8 Cil, 6.4L	2018-2021	80013WS	0986MF0013	5860WS	0986MF4404				
Ram	4000	8 Cil, 5.7L	2011-2012	80029WS	0986MF0029	5860WS	0986MF4404				
Ram	4000	8 Cil, 5.7L	2013-2016	80013WS	0986MF0013	5860WS	0986MF4404				
Ram	4000	8 Cil, 5.7L	2017-2018	80013WS	0986MF0013						
Ram	4000	8 Cil, 5.7L	2017-2021	80013WS	0986MF0013						
Ram	RAM 700	4 Cil, 1.6L	2015-2020			84150WS	0986MF4150				
Renault	Alliance	4 Cil, 1.4L	1984					77150WS	0986MF2057		
Renault	Alliance	4 Cil, 1.7L	1985-1986					77150WS	0986MF2057		
Renault	Captur	4 Cil, 2.0L	2018-2021	80026WS	0986MF0026						
Renault	Clio	4 Cil, 2.0L	2002-2006	80026WS	0986MF0026	84229WS / 84173WS*	0986MF4229 / 0986MF4173*	82426WS	0986MF2426		
Renault	Clio	4 Cil, 1.6L	2002-2010	80026WS	0986MF0026	84229WS / 84173WS*	0986MF4229 / 0986MF4173*	82426WS	0986MF2426		







		 									
Marca	Modelo	Motor	Año	Num. Corto	10 Dígitos	Num. Corto	10 Dígitos	Num. Corto	10 Dígitos		
Renault	Clio	4 Cil, 1.6L	2015	80026WS	0986MF0026	84229WS	0986MF4229	82426WS	0986MF2426		
Renault	Clio	4 Cil, 1.6L	2017	80022WS	0986MF0022	84229WS	0986MF4229	82426WS	0986MF2426		
Renault	Duster	4 Cil, 2.0L	2013-2020	80026WS	0986MF0026	84229WS / 84173WS*	0986MF4229 / 0986MF4173*	82426WS	0986MF2426		
Renault	Euro Clio	4 Cil, 1.6L	2007-2008	80026WS	0986MF0026	84229WS	0986MF4229	82426WS	0986MF2426		
Renault	Fluence	4 Cil, 2.0L	2011-2017	80022WS	0986MF0022	84087WS	0986MF4087	82426WS	0986MF2426		
Renault	Kangoo	4 Cil, 1.6L	2007-2009			84229WS / 84173WS*	0986MF4229 / 0986MF4173*	82426WS	0986MF2426		
Renault	Kangoo	4 Cil, 1.6L	2014-2019	80026WS	0986MF0026	84229WS / 84173WS*	0986MF4229 / 0986MF4173*	82426WS	0986MF2426		
Renault	Kangoo Express	4 Cil, 1.6L	2004-2013	80026WS	0986MF0026	84229WS / 84173WS*	0986MF4229 / 0986MF4173*	82426WS	0986MF2426		
Renault	Koleos	4 Cil, 2.5L	2009-2016	80022WS	0986MF0022						
Renault	Koleos	4 Cil, 2.5L	2017-2020	80022WS	0986MF0022	5823WS	0986MF4100				
Renault	Laguna	6 Cil, 2.9L	2003-2006	80026WS	0986MF0026						
Renault	Logan	4 Cil, 1.6L	2015-2017	80026WS	0986MF0026	84229WS / 84173WS*	0986MF4229 / 0986MF4173*	82426WS	0986MF2426		
Renault	Logan	4 Cil, 1.6L	2018-2019	80026WS	0986MF0026	84229WS / 84173WS*	0986MF4229 / 0986MF4173*	82426WS	0986MF2426		
Renault	Megane	4 Cil, 2.0L	2001-2002	80026WS	0986MF0026			82426WS	0986MF2426		
Renault	Megane	4 Cil, 2.0L	2005-2008	80026WS	0986MF0026			82426WS	0986MF2426		
Renault	Megane	4 Cil, 1.6L	2008-2009	80026WS	0986MF0026						
Renault	Megane	4 Cil, 1.6L	2010	80026WS	0986MF0026						
Renault	Oroch	4 Cil, 2.0L	2018-2020	80026WS	0986MF0026						
Renault	R12	4 Cil, 1.6L	1975-1977					77150WS	0986MF2057		
Renault	R12	4 Cil, 1.6L	1978-1979					77150WS	0986MF2057		
Renault	R12	4 Cil, 1.3L	1974-1980					77150WS	0986MF2057		
Renault	R12	4 Cil, 1.6L	1975-1980					77150WS	0986MF2057		
Renault	R12	4 Cil, 1.3L	1981-1982					77150WS	0986MF2057		
Renault	R12	4 Cil, 1.3L	1981-1983					77150WS	0986MF2057		
Renault	R12	4 Cil, 1.6L	1983-1984					77150WS	0986MF2057		
Renault	R18	4 Cil, 1.6L	1981-1982					77150WS	0986MF2057		
Renault	R18	4 Cil, 1.6L	1980-1984					77150WS	0986MF2057		
Renault	R18	4 Cil, 1.6L	1983-1984					77150WS	0986MF2057		







											
Marca	Modelo	Motor	Año	Num. Corto	10 Dígitos	Num. Corto	10 Dígitos	Num. Corto	10 Dígitos		
Renault	R18	4 Cil, 2.0L	1984-1986					77150WS	0986MF2057		
Renault	R5	4 Cil, 1.3L	1977-1983					77150WS	0986MF2057		
Renault	Safrane	6 Cil, 3.5L	2011-2015	72273WS	F00E164931						
Renault	Sandero	4 Cil, 1.6L	2010-2011			84173WS	0986MF4173*	82426WS	0986MF2426		
Renault	Sandero	4 Cil, 1.6L	2010-2015	80026WS	0986MF0026	84173WS	0986MF4173*	82426WS	0986MF2426		
Renault	Sandero	4 Cil, 1.6L	2017-2019	80026WS	0986MF0026	84173WS	0986MF4173*	82426WS	0986MF2426		
Renault	Sandero	4 Cil, 2.0L	2016-2020	80026WS	0986MF0026			82426WS	0986MF2426		
Renault	Scenic	4 Cil, 2.0L	2001-2003	80026WS	0986MF0026	84229WS / 84173WS*	0986MF4229 / 0986MF4173*	82426WS	0986MF2426		
Renault	Scenic	4 Cil, 2.0L	2004-2008	80026WS	0986MF0026	84229WS / 84173WS*	0986MF4229 / 0986MF4173*	82426WS	0986MF2426		
Renault	Stepway	4 Cil, 1.6L	2010-2019	80026WS	0986MF0026	84229WS / 84173WS*	0986MF4229 / 0986MF4173*	82426WS	0986MF2426		
Renault	Trafic - Diesel	4 Cil, 1.9L	2007-2014	80026WS	0986MF0026	84199WS	0986MF4199				
Saab	9-3	4 Cil, 2.0L	2001-2002	80034WS	0986MF0034						
Saab	9-3	4 Cil, 2.0L	2004-2005	80034WS	0986MF0034						
Saab	9-3	4 Cil, 2.0L	2004-2009	80021WS	0986MF0021						
Saab	9-5	4 Cil, 2.3L	2002	80034WS	0986MF0034						
Saab	9-5	6 Cil, 3.0L	2002	80034WS	0986MF0034						
Saab	9-5	4 Cil, 2.3L	2002-2006	80034WS	0986MF0034						
Seat	Alhambra	4 Cil, 1.8L	2002-2007	80044WS / 80019WS*	0986MF0044 / 0986MF0019*						
Seat	Altea	4 Cil, 2.0L	2005-2006	80000WS	0986MF0000	5809WS	0986MF4008	82900WS	0986MF2900		
Seat	Altea XL	4 Cil, 1.8L	2014-2015	80014WS	0986MF0014			82425WS	0986MF2425		
Seat	Ateca	4 Cil, 1.4L	2017-2018	80049WS	0986MF0049	84151WS	0986MF4151				
Seat	Ateca	4 Cil, 1.4L	2019-2021	80049WS	0986MF0049						
Seat	Cordoba	4 Cil, 1.6L	2001-2002	80044WS / 80019WS*	0986MF0044 / 0986MF0019*	84099WS	0986MF4099	82900WS	0986MF2900		
Seat	Cordoba	4 Cil, 1.6L	2004-2009	72275WS	F00E164933	5895WS	0986MF4612	82425WS	0986MF2425		
Seat	Cordoba	4 Cil, 2.0L	2003-2009	80044WS / 80019WS*	0986MF0044 / 0986MF0019*	84099WS	0986MF4099	82900WS	0986MF2900		
Seat	Exeo	4 Cil, 2.0L	2011	80000WS	0986MF0000						
Seat	Freetrack	4 Cil, 2.0L	2009-2015	80000WS	0986MF0000						
Seat	Ibiza	4 Cil, 1.6L	2014-2016	80044WS / 80019WS*	0986MF0044 / 0986MF0019*	84105WS	0986MF4105	82425WS	0986MF2425		







		 			Filtro de aceite 	Filtro de aire 	Filtro de gasolina 		
Marca	Modelo	Motor	Año	Num. Corto	10 Dígitos	Num. Corto	10 Dígitos	Num. Corto	10 Dígitos
Seat	Ibiza	4 Cil, 1.6L	2017-2020	80044WS / 80019WS*	0986MF0044 / 0986MF0019*	84219WS	0986MF4219	82425WS	0986MF2425
Seat	Ibiza	4 Cil, 1.6L	2001-2002	80044WS / 80019WS*	0986MF0044 / 0986MF0019*	5898WS	0986MF4620	82900WS	0986MF2900
Seat	Ibiza	4 Cil, 1.8L	2005-2008	80044WS / 80019WS*	0986MF0044 / 0986MF0019*			77210WS	0986MF2280
Seat	Ibiza	4 Cil, 1.6L	2004-2009	80044WS / 80019WS*	0986MF0044 / 0986MF0019*	5895WS	0986MF4612	82900WS	0986MF2900
Seat	Ibiza	4 Cil, 2.0L	2003-2009	80044WS / 80019WS*	0986MF0044 / 0986MF0019*	84099WS	0986MF4099	82900WS	0986MF2900
Seat	Ibiza	4 Cil, 1.4L	2011-2012	80051WS	0986MF0051				
Seat	Ibiza	4 Cil, 1.4L	2013-2015	80051WS	0986MF0051	84151WS	0986MF4151		
Seat	Ibiza	4 Cil, 1.6L	2010-2015	80044WS / 80019WS*	0986MF0044 / 0986MF0019*	84105WS	0986MF4105	82425WS	0986MF2425
Seat	Ibiza	4 Cil, 2.0L	2010-2015	80044WS / 80019WS*	0986MF0044 / 0986MF0019*	84099WS	0986MF4099	82425WS	0986MF2425
Seat	Ibiza	4 Cil, 1.6L	2016			84105WS	0986MF4105	82425WS	0986MF2425
Seat	Ibiza	4 Cil, 1.2L	2017	80049WS	0986MF0049	84151WS	0986MF4151		
Seat	Leon	4 Cil, 1.8L	2001-2006	80044WS / 80019WS*	0986MF0044 / 0986MF0019*	5893WS	0986MF4602	77215WS	0986MF2318
Seat	Leon	4 Cil, 1.4L	2014-2020	80049WS	0986MF0049	84151WS	0986MF4151		
Seat	Leon	4 Cil, 1.6L	2007	80044WS / 80019WS*	0986MF0044 / 0986MF0019*	84224WS	0986MF4224	77215WS	0986MF2318
Seat	Leon	4 Cil, 1.4L	2008-2013	80051WS	0986MF0051	84224WS	0986MF4224	82425WS	0986MF2425
Seat	Leon	4 Cil, 2.0L	2007-2013	80000WS	0986MF0000	84222WS	0986MF4222		
Seat	Leon	4 Cil, 1.8L	2013-2018	80014WS	0986MF0014	84096WS	0986MF4096		
Seat	Leon	4 Cil, 2.0L	2015-2019			84222WS	0986MF4222		
Seat	Nuevo Ibiza	4 Cil, 2.0L	2010	80044WS / 80019WS*	0986MF0044 / 0986MF0019*	84099WS	0986MF4099	82425WS	0986MF2425
Seat	Toledo	4 Cil, 1.8L	2001-2005	80044WS / 80019WS*	0986MF0044 / 0986MF0019*	5893WS	0986MF4602	77215WS	0986MF2318
Seat	Toledo	4 Cil, 1.4L	2013-2015	80051WS	0986MF0051	84143WS	0986MF4143		
Seat	Toledo	4 Cil, 1.6L	2013-2019	80051WS	0986MF0051	84105WS	0986MF4105	82425WS	0986MF2425
Smart	Forfour	4 Cil, 1.5L	2005-2007	80081WS	0986MF0081				
Smart	Fortwo	3 Cil, 1.0L	2008-2015	80022WS	0986MF0022				
SRT	Viper	10 Cil, 8.4L	2013-2014	80029WS	0986MF0029				







		 Cil.  CC				Filtro de aceite 		Filtro de aire 		Filtro de gasolina 	
Marca	Modelo	Motor	Año	Num. Corto	10 Dígitos	Num. Corto	10 Dígitos	Num. Corto	10 Dígitos	Num. Corto	10 Dígitos
Subaru	B9 Tribeca	6 Cil, 3.0L	2006-2007	80022WS	0986MF0022						
Subaru	BRZ	4 Cil, 2.0L	2016-2020	80081WS	0986MF0081						
Subaru	Forester	4 Cil, 2.5L	2008-2012	80022WS	0986MF0022						
Subaru	Forester	4 Cil, 2.0L	2014-2018	72273WS	F00E164931						
Subaru	Forester	4 Cil, 2.5L	2014-2018	72273WS	F00E164931						
Subaru	Impreza	4 Cil, 2.0L	2008-2017	72273WS	F00E164931						
Subaru	Impreza	4 Cil, 2.5L	2007	80022WS	0986MF0022	5841WS	0986MF4309				
Subaru	Impreza	4 Cil, 2.5L	2009-2011	80022WS	0986MF0022						
Subaru	Impreza	4 Cil, 2.5L	2012-2014	72273WS	F00E164931						
Subaru	Legacy	4 Cil, 2.5L	2009-2014	80022WS	0986MF0022						
Subaru	Legacy	6 Cil, 3.0L	2008-2009	80081WS	0986MF0081						
Subaru	Legacy	4 Cil, 2.5L	2015	72273WS	F00E164931						
Subaru	Legacy	6 Cil, 3.6L	2014-2015	80081WS	0986MF0081						
Subaru	Outback	4 Cil, 2.5L	2006-2008	80022WS	0986MF0022						
Subaru	Outback	4 Cil, 2.5L	2014	72273WS	F00E164931						
Subaru	Outback	4 Cil, 2.5L	2010-2015	80022WS	0986MF0022						
Subaru	Outback	6 Cil, 3.6L	2011-2015	80022WS	0986MF0022						
Subaru	Outback	4 Cil, 2.5L	2015-2017	72273WS	F00E164931						
Subaru	Outback	6 Cil, 3.6L	2017	80081WS	0986MF0081						
Subaru	Tribeca	6 Cil, 3.6L	2008-2012	80081WS	0986MF0081						
Subaru	WRX	4 Cil, 2.5L	2012	72273WS	F00E164931						
Subaru	WRX	4 Cil, 2.5L	2013	80022WS	0986MF0022						
Subaru	WRX	4 Cil, 2.0L	2015-2020	80081WS	0986MF0081						
Subaru	WRX STI	4 Cil, 2.5L	2015-2020	80022WS	0986MF0022						
Subaru	XV	4 Cil, 2.0L	2013-2016	72273WS	F00E164931						
Suzuki	Grand Vitara	4 Cil, 2.4L	2009-2017	80028WS	0986MF0028	84193WS	0986MF4193				
Suzuki	Kizashi	4 Cil, 2.4L	2010-2013	80028WS	0986MF0028						
Suzuki	Kizashi	4 Cil, 2.4L	2015-2016	80028WS	0986MF0028						
Suzuki	S-Cross	4 Cil, 1.6L	2014	80028WS	0986MF0028						
Suzuki	S-Cross	4 Cil, 1.4L	2017-2021	80028WS	0986MF0028						
Suzuki	S-Cross	4 Cil, 1.6L	2014-2021	80028WS	0986MF0028						
Suzuki	Swift	4 Cil, 1.5L	2007-2011	80028WS	0986MF0028	84194WS	0986MF4194				







											
Marca	Modelo	Motor	Año	Num. Corto	10 Dígitos	Num. Corto	10 Dígitos	Num. Corto	10 Dígitos	Num. Corto	10 Dígitos
Suzuki	Swift	4 Cil, 1.4L	2012-2017	80028WS	0986MF0028	84012WS	0986MF4012				
Suzuki	Swift	4 Cil, 1.6L	2013-2017	80028WS	0986MF0028	84012WS	0986MF4012				
Suzuki	SX4	4 Cil, 2.0L	2008-2014	80028WS	0986MF0028	84049WS	0986MF4049				
Suzuki	Vitara	4 Cil, 1.6L	2016-2021	80028WS	0986MF0028						
Toyota	4Runner	8 Cil, 4.7L	2003-2008	80034WS	0986MF0034	84188WS	0986MF4188				
Toyota	Avanza	4 Cil, 1.5L	2007-2012	80028WS	0986MF0028						
Toyota	Avanza	4 Cil, 1.5L	2013-2015	80011WS	0986MF0011	84039WS	0986MF4039				
Toyota	Avanza	4 Cil, 1.5L	2016-2021	80011WS	0986MF0011	84137WS	0986MF4137				
Toyota	Camry	6 Cil, 3.5L	2007-2011	80048WS	0986MF0048	84046WS	0986MF4046				
Toyota	Camry	6 Cil, 3.0L	2002-2006	80034WS	0986MF0034	84185WS	0986MF4185				
Toyota	Camry	4 Cil, 2.4L	2002-2009	80028WS	0986MF0028	84185WS	0986MF4185				
Toyota	Camry	4 Cil, 2.5L	2010-2017	80048WS	0986MF0048	84068WS	0986MF4068				
Toyota	Camry	6 Cil, 3.5L	2012-2017	80048WS	0986MF0048	84257WS	0986MF4257				
Toyota	Corolla	4 Cil, 1.8L	2009-2012	80011WS	0986MF0011	84036WS	0986MF4036				
Toyota	Corolla	4 Cil, 2.4L	2009-2013	80028WS	0986MF0028	84046WS	0986MF4046				
Toyota	Corolla	4 Cil, 1.8L	2017	80011WS	0986MF0011	84036WS	0986MF4036				
Toyota	Corolla	4 Cil, 1.8L	2018-2021	80011WS	0986MF0011	84036WS	0986MF4036				
Toyota	FJ Cruiser	6 Cil, 4.0L	2008-2014	80034WS	0986MF0034	5907WS	0986MF4683				
Toyota	Hiace	4 Cil, 2.7L	2006-2019	80034WS	0986MF0034	5879WS	0986MF4501				
Toyota	Highlander	6 Cil, 3.5L	2008-2016	80048WS	0986MF0048	84257WS	0986MF4257				
Toyota	Highlander	6 Cil, 3.5L	2017-2021			84257WS	0986MF4257				
Toyota	Hilux	4 Cil, 2.7L	2004-2005	80034WS	0986MF0034	84062WS	0986MF4062				
Toyota	Hilux	4 Cil, 2.7L	2006-2008	80034WS	0986MF0034	84062WS	0986MF4062				
Toyota	Hilux	4 Cil, 2.7L	2009-2012	80034WS	0986MF0034	84062WS	0986MF4062				
Toyota	Hilux	4 Cil, 2.7L	2013-2016	80034WS	0986MF0034	84062WS	0986MF4062				
Toyota	Hilux	4 Cil, 2.7L	2017-2021	80034WS	0986MF0034	84062WS	0986MF4062				
Toyota	Land Cruiser	8 Cil, 4.7L	2004-2007	80034WS	0986MF0034	84188WS	0986MF4188				
Toyota	Land Cruiser	8 Cil, 5.7L	2008-2021			84197WS	0986MF4197				
Toyota	Matrix	4 Cil, 1.8L	2009-2010	80048WS	0986MF0048						
Toyota	MR2 Spyder	4 Cil, 1.8L	2005-2006	80011WS	0986MF0011						
Toyota	Prius	4 Cil, 1.8L	2010-2015	80048WS	0986MF0048						
Toyota	Prius	4 Cil, 1.8L	2016-2021	80048WS	0986MF0048						







		 Cil.  CC			 Filtro de aceite		 Filtro de aire		 Filtro de gasolina	
Marca	Modelo	Motor	Año	Num. Corto	10 Dígitos	Num. Corto	10 Dígitos	Num. Corto	10 Dígitos	
Toyota	Prius C	4 Cil, 1.5L	2018-2021	80011WS	0986MF0011					
Toyota	RAV4	4 Cil, 2.5L	2009-2012	80048WS	0986MF0048	84046WS	0986MF4046			
Toyota	RAV4	4 Cil, 2.4L	2004-2005	80028WS	0986MF0028	84190WS	0986MF4190			
Toyota	RAV4	4 Cil, 2.4L	2006-2008	80028WS	0986MF0028	84046WS	0986MF4046			
Toyota	RAV4	6 Cil, 3.5L	2009-2012	80048WS	0986MF0048	84046WS	0986MF4046			
Toyota	RAV4	4 Cil, 2.5L	2013-2019	80048WS	0986MF0048	84144WS	0986MF4144			
Toyota	Sequoia	8 Cil, 4.7L	2008-2012	80034WS	0986MF0034	84197WS	0986MF4197			
Toyota	Sequoia	8 Cil, 5.7L	2009-2021			84197WS	0986MF4197			
Toyota	Sienna	6 Cil, 3.5L	2008-2010	80048WS	0986MF0048	84185WS	0986MF4185			
Toyota	Sienna	6 Cil, 3.0L	2003	80034WS	0986MF0034	84266WS	0986MF4266			
Toyota	Sienna	6 Cil, 3.3L	2004-2006	80034WS	0986MF0034	84185WS	0986MF4185			
Toyota	Sienna	6 Cil, 3.5L	2011-2016	80048WS	0986MF0048	84257WS	0986MF4257			
Toyota	Sienna	6 Cil, 3.5L	2017-2020	80048WS	0986MF0048	84257WS	0986MF4257			
Toyota	Solara	6 Cil, 3.3L	2005-2006	80034WS	0986MF0034	84185WS	0986MF4185			
Toyota	Tacoma	6 Cil, 4.0L	2006-2015	80034WS	0986MF0034	5907WS	0986MF4683			
Toyota	Tacoma	6 Cil, 3.5L	2016-2021	80048WS	0986MF0048	5907WS	0986MF4683			
Toyota	Tundra	6 Cil, 4.0L	2007	80034WS	0986MF0034	5907WS	0986MF4683			
Toyota	Tundra	8 Cil, 4.7L	2007-2010	80034WS	0986MF0034	84197WS	0986MF4197			
Toyota	Tundra	8 Cil, 5.7L	2010-2017			84197WS	0986MF4197			
Toyota	Tundra	8 Cil, 5.7L	2009-2021			84197WS	0986MF4197			
Toyota	Yaris	4 Cil, 1.5L	2006-2016	80011WS	0986MF0011	84036WS	0986MF4036			
Toyota	Yaris	4 Cil, 1.3L	2004-2005	80011WS	0986MF0011	5824WS	0986MF4103			
VAM	American	6 Cil, 4.2L	1976-1983					82890WS	0986MF2890	
VAM	Classic	6 Cil, 4.6L	1975-1976					82890WS	0986MF2890	
VAM	Gremlin	6 Cil, 4.2L	1976-1983					82890WS	0986MF2890	
VAM	Gremlin	6 Cil, 4.6L	1979-1983					82890WS	0986MF2890	
VAM	Lerma	6 Cil, 4.6L	1981					82890WS	0986MF2890	
VAM	Pacer	6 Cil, 4.6L	1976-1978					82890WS	0986MF2890	
VAM	Rally	6 Cil, 4.6L	1981-1984			5828WS	0986MF4184	82890WS	0986MF2890	
Volkswagen	Amarok	4 Cil, 2.0L	2011-2016			84218WS	0986MF4218			
Volkswagen	Amarok	4 Cil, 2.0L	2017-2018	80014WS	0986MF0014	84218WS	0986MF4218			
Volkswagen	Amarok	6 Cil, 3.0L	2018-2019	80014WS	0986MF0014					







											
Marca	Modelo	Motor	Año	Num. Corto	10 Dígitos	Num. Corto	10 Dígitos	Num. Corto	10 Dígitos		
Volkswagen	Amarok	4 Cil, 2.0L	2019-2020			84218WS	0986MF4218				
Volkswagen	Atlantic	4 Cil, 1.6L	1981	80044WS / 80019WS*	0986MF0044 / 0986MF0019*	84227WS	0986MF4227	77219WS	0986MF2889		
Volkswagen	Atlantic	4 Cil, 1.7L	1982-1987	80044WS / 80019WS*	0986MF0044 / 0986MF0019*	84227WS	0986MF4227	77219WS	0986MF2889		
Volkswagen	Beetle	4 Cil, 2.0L	1998-2005	80044WS / 80019WS*	0986MF0044 / 0986MF0019*	5893WS	0986MF4602	77215WS	0986MF2318		
Volkswagen	Beetle	4 Cil, 2.0L	2007-2009	80044WS / 80019WS*	0986MF0044 / 0986MF0019*	5893WS	0986MF4602	77215WS	0986MF2318		
Volkswagen	Beetle	4 Cil, 2.0L	2007-2009	80044WS / 80019WS*	0986MF0044 / 0986MF0019*	5895WS	0986MF4612	77215WS	0986MF2318		
Volkswagen	Beetle	4 Cil, 2.0L	2010-2012	80044WS / 80019WS*	0986MF0044 / 0986MF0019*	5893WS	0986MF4602	77215WS	0986MF2318		
Volkswagen	Beetle	4 Cil, 1.8L	2000-2004	80044WS / 80019WS*	0986MF0044 / 0986MF0019*	5893WS	0986MF4602	77215WS	0986MF2318		
Volkswagen	Beetle	5 Cil, 2.5L	2008-2011	80000WS	0986MF0000	5893WS	0986MF4602	77215WS	0986MF2318		
Volkswagen	Beetle	5 Cil, 2.5L	2012-2014	80000WS	0986MF0000	5809WS	0986MF4008	77215WS	0986MF2318		
Volkswagen	Beetle	5 Cil, 2.5L	2015-2019	80000WS	0986MF0000	5809WS	0986MF4008	82425WS	0986MF2425		
Volkswagen	Beetle Cabrio	5 Cil, 2.5L	2011	80000WS	0986MF0000	5809WS	0986MF4008	77215WS	0986MF2318		
Volkswagen	Bora	5 Cil, 2.5L	2006-2010	80000WS	0986MF0000	5809WS	0986MF4008	82425WS	0986MF2425		
Volkswagen	Bora	4 Cil, 2.0L	2006-2009	80000WS	0986MF0000	84224WS	0986MF4224				
Volkswagen	Bora-Diesel	4 Cil, 1.9L	2007-2010	80007WS	0986MF0007	84096WS	0986MF4096				
Volkswagen	Brasilia	4 Cil, 1.6L	1974-1982			5855WS	0986MF4399	77150WS	0986MF2057		
Volkswagen	Cabrio	4 Cil, 2.0L	1996-2002	80044WS / 80019WS*	0986MF0044 / 0986MF0019*	5952WS	0986MF4431	77131WS	0986MF2030		
Volkswagen	Caddy	4 Cil, 1.2L	2014-2016	80051WS	0986MF0051	84224WS	0986MF4224				
Volkswagen	Caddy	4 Cil, 1.2L	2017	80051WS	0986MF0051	84151WS	0986MF4151				
Volkswagen	Caddy	4 Cil, 1.6L	2018-2020	80051WS	0986MF0051	84105WS	0986MF4105				
Volkswagen	Caribe	4 Cil, 1.6L	1977-1980	80044WS / 80019WS*	0986MF0044 / 0986MF0019*	84226WS	0986MF4226	77150WS	0986MF2057		
Volkswagen	Caribe	4 Cil, 1.7L	1981-1987	80044WS / 80019WS*	0986MF0044 / 0986MF0019*	84226WS	0986MF4226	77219WS	0986MF2889		
Volkswagen	Caribe	4 Cil, 1.8L	1984-1987	80044WS / 80019WS*	0986MF0044 / 0986MF0019*	84226WS	0986MF4226	77219WS	0986MF2889		
Volkswagen	CC	6 Cil, 3.6L	2013-2016			84223WS	0986MF4223				
Volkswagen	CC	4 Cil, 2.0L	2013-2017	80014WS	0986MF0014	84096WS	0986MF4096				

		 Cil.  CC								
Marca	Modelo	Motor	Año	Num. Corto	10 Dígitos	Num. Corto	10 Dígitos	Num. Corto	10 Dígitos	
Volkswagen	Clasico	4 Cil, 2.0L	2011-2015	80044WS / 80019WS*	0986MF0044 / 0986MF0019*	84224WS	0986MF4224			
Volkswagen	Combi	4 Cil, 1.6L	1974-1988			5855WS	0986MF4399	77150WS	0986MF2057	
Volkswagen	Combi	4 Cil, 1.8L	1988-1997	80044WS / 80019WS*	0986MF0044 / 0986MF0019*	84230WS	0986MF4230	77219WS	0986MF2889	
Volkswagen	Combi	4 Cil, 1.8L	1997-2001	80044WS / 80019WS*	0986MF0044 / 0986MF0019*	84230WS	0986MF4230			
Volkswagen	Corsar	4 Cil, 1.8L	1984-1988	80044WS / 80019WS*	0986MF0044 / 0986MF0019*	84249WS	0986MF4249	77219WS	0986MF2889	
Volkswagen	CrossFox	4 Cil, 1.6L	2007-2017	72275WS	F00E164933	5895WS	0986MF4612	77219WS	0986MF2889	
Volkswagen	Derby	4 Cil, 1.8L	1995-2009	80044WS / 80019WS*	0986MF0044 / 0986MF0019*	5825WS	0986MF4116	77210WS	0986MF2280	
Volkswagen	Derby	4 Cil, 2.0L	2002-2003	80044WS / 80019WS*	0986MF0044 / 0986MF0019*	5825WS	0986MF4116	77210WS	0986MF2280	
Volkswagen	Eos	4 Cil, 2.0L	2010	80014WS	0986MF0014	84096WS	0986MF4096			
Volkswagen	EuroVan	5 Cil, 2.5L	2001-2004			5903WS	0986MF4651	77131WS	0986MF2030	
Volkswagen	EuroVan	6 Cil, 2.8L	2000	80032WS	0986MF0032	5903WS	0986MF4651			
Volkswagen	EuroVan - Diesel	4 Cil, 1.9L	2006-2009	80007WS	0986MF0007	5808WS	0986MF4007			
Volkswagen	Gol	4 Cil, 1.6L	2016-2019	72275WS	F00E164933	84104WS	0986MF4104	82426WS	0986MF2426	
Volkswagen	Gol	4 Cil, 1.6L	2009-2013	72275WS	F00E164933	84104WS	0986MF4104	82426WS	0986MF2426	
Volkswagen	Gol Sedan	4 Cil, 1.6L	2010-2012	72275WS	F00E164933	84104WS	0986MF4104	82426WS	0986MF2426	
Volkswagen	Golf	4 Cil, 2.0L	1999-2006	80044WS / 80019WS*	0986MF0044 / 0986MF0019*	5893WS	0986MF4602	77215WS	0986MF2318	
Volkswagen	Golf	4 Cil, 1.4L	2013-2019	80051WS	0986MF0051	84151WS	0986MF4151			
Volkswagen	Golf	4 Cil, 1.8L	1987-1992	80044WS / 80019WS*	0986MF0044 / 0986MF0019*	84227WS	0986MF4227	77219WS	0986MF2889	
Volkswagen	Golf	4 Cil, 2.0L	1995-1998	80044WS / 80019WS*	0986MF0044 / 0986MF0019*	5952WS	0986MF4431	77131WS	0986MF2030	
Volkswagen	Golf	6 Cil, 2.8L	1996-1998	80044WS / 80019WS*	0986MF0044 / 0986MF0019*	5952WS	0986MF4431	77131WS	0986MF2030	
Volkswagen	Golf	4 Cil, 1.8L	1993-1999	80044WS / 80019WS*	0986MF0044 / 0986MF0019*	5952WS	0986MF4431	77131WS	0986MF2030	
Volkswagen	Golf	4 Cil, 1.8L	2001	80044WS / 80019WS*	0986MF0044 / 0986MF0019*	5893WS	0986MF4602	77215WS	0986MF2318	
Volkswagen	Golf	4 Cil, 1.8L	2003-2005	80044WS / 80019WS*	0986MF0044 / 0986MF0019*	5893WS	0986MF4602	77215WS	0986MF2318	

											
Marca	Modelo	Motor	Año	Num. Corto	10 Dígitos	Num. Corto	10 Dígitos	Num. Corto	10 Dígitos		
Volkswagen	Golf	4 Cil, 2.0L	2007			84222WS	0986MF4222				
Volkswagen	Golf SportWagen	5 Cil, 2.5L	2010-2013	80000WS	0986MF0000	5809WS	0986MF4008	82425WS	0986MF2425		
Volkswagen	GTI	4 Cil, 2.0L	2007-2008	80000WS	0986MF0000						
Volkswagen	GTI	4 Cil, 2.0L	2009-2013	80014WS	0986MF0014						
Volkswagen	Jetta	4 Cil, 1.8L	1987-1992	80044WS / 80019WS*	0986MF0044 / 0986MF0019*	5882WS	0986MF4545				
Volkswagen	Jetta	4 Cil, 1.8L	1993-1999	80044WS / 80019WS*	0986MF0044 / 0986MF0019*	5952WS	0986MF4431	77131WS	0986MF2030		
Volkswagen	Jetta	4 Cil, 2.0L	2002-2004	80044WS / 80019WS*	0986MF0044 / 0986MF0019*	5893WS	0986MF4602	77215WS	0986MF2318		
Volkswagen	Jetta	4 Cil, 2.0L	1993-1999	80044WS / 80019WS*	0986MF0044 / 0986MF0019*	5952WS	0986MF4431	77131WS	0986MF2030		
Volkswagen	Jetta	4 Cil, 2.0L	2000-2001	80044WS / 80019WS*	0986MF0044 / 0986MF0019*	5893WS	0986MF4602	77131WS	0986MF2030		
Volkswagen	Jetta	6 Cil, 2.8L	1999-2002	80032WS	0986MF0032	5893WS	0986MF4602				
Volkswagen	Jetta	4 Cil, 1.8L	2002-2005	80044WS / 80019WS*	0986MF0044 / 0986MF0019*	5893WS	0986MF4602	77215WS	0986MF2318		
Volkswagen	Jetta	4 Cil, 2.0L	2007-2008			84222WS	0986MF4222	77215WS	0986MF2318		
Volkswagen	Jetta	4 Cil, 1.8L	2009-2010	80044WS / 80019WS*	0986MF0044 / 0986MF0019*			77215WS	0986MF2318		
Volkswagen	Jetta	4 Cil, 2.0L	2005-2010	80044WS / 80019WS*	0986MF0044 / 0986MF0019*	5893WS	0986MF4602	77215WS	0986MF2318		
Volkswagen	Jetta	4 Cil, 2.0L	2013-2016	80044WS / 80019WS*	0986MF0044 / 0986MF0019*	84224WS	0986MF4224	82425WS	0986MF2425		
Volkswagen	Jetta	4 Cil, 2.0L	2017-2018			84224WS	0986MF4224	82425WS	0986MF2425		
Volkswagen	Jetta	5 Cil, 2.5L	2011-2018	80000WS	0986MF0000	5809WS	0986MF4008	82425WS	0986MF2425		
Volkswagen	Jetta	4 Cil, 1.4L	2019-2021	80049WS	0986MF0049	84151WS	0986MF4151				
Volkswagen	Jetta - Diesel	4 Cil, 1.9L	2006-2010	80007WS	0986MF0007	5893WS	0986MF4602	77215WS	0986MF2318		
Volkswagen	Jetta City	4 Cil, 2.0L	2008-2009	80044WS / 80019WS*	0986MF0044 / 0986MF0019*	5893WS	0986MF4602	77215WS	0986MF2318		
Volkswagen	Lupo	4 Cil, 1.6L	2005-2009	72275WS	F00E164933	5895WS	0986MF4612	77219WS	0986MF2889		
Volkswagen	Nuevo Gol	4 Cil, 1.6L	2013-2020	72275WS	F00E164933	84104WS	0986MF4104	82426WS	0986MF2426		
Volkswagen	Passat	4 Cil, 2.0L	1991-1993	80044WS / 80019WS*	0986MF0044 / 0986MF0019*	5882WS	0986MF4545				
Volkswagen	Passat	6 Cil, 2.8L	1999-2005	80012WS	0986MF0012	84265WS	0986MF4265	77131WS	0986MF2030		
Volkswagen	Passat	6 Cil, 2.8L	1996-1997	80012WS	0986MF0012	5952WS	0986MF4431	77131WS	0986MF2030		

		 Cil.  CC								
Marca	Modelo	Motor	Año	Num. Corto	10 Dígitos	Num. Corto	10 Dígitos	Num. Corto	10 Dígitos	
Volkswagen	Passat	4 Cil, 1.8L	2000			84265WS	0986MF4265			
Volkswagen	Passat	4 Cil, 1.8L	2001-2005	80044WS / 80019WS*	0986MF0044 / 0986MF0019*	84265WS	0986MF4265	77131WS	0986MF2030	
Volkswagen	Passat	4 Cil, 2.0L	2006-2008			84222WS	0986MF4222			
Volkswagen	Passat	4 Cil, 2.0L	2009-2010	80000WS	0986MF0000	84096WS	0986MF4096			
Volkswagen	Passat	5 Cil, 2.5L	2012-2014	80000WS	0986MF0000	5809WS	0986MF4008	82425WS	0986MF2425	
Volkswagen	Passat	5 Cil, 2.5L	2015-2016					82425WS	0986MF2425	
Volkswagen	Passat	5 Cil, 2.5L	2016-2017	80000WS	0986MF0000	5809WS	0986MF4008	82425WS	0986MF2425	
Volkswagen	Passat	6 Cil, 3.6L	2012-2018			84223WS	0986MF4223			
Volkswagen	Passat CC	6 Cil, 3.6L	2010-2011			84223WS	0986MF4223			
Volkswagen	Passat CC	4 Cil, 2.0L	2010-2012	80000WS	0986MF0000	84096WS	0986MF4096			
Volkswagen	Pointer	4 Cil, 1.8L	1998	80044WS / 80019WS*	0986MF0044 / 0986MF0019*	5896WS	0986MF4614	77131WS	0986MF2030	
Volkswagen	Pointer	4 Cil, 2.0L	2000-2003	80044WS / 80019WS*	0986MF0044 / 0986MF0019*	5896WS	0986MF4614	77219WS	0986MF2889	
Volkswagen	Pointer	4 Cil, 1.8L	1998-2005	80044WS / 80019WS*	0986MF0044 / 0986MF0019*	5896WS	0986MF4614	77219WS	0986MF2889	
Volkswagen	Pointer	4 Cil, 1.8L	2006-2009	80044WS / 80019WS*	0986MF0044 / 0986MF0019*	5896WS	0986MF4614	77219WS	0986MF2889	
Volkswagen	Pointer Truck	4 Cil, 1.8L	1999-2010	80044WS / 80019WS*	0986MF0044 / 0986MF0019*	5896WS	0986MF4614	77219WS	0986MF2889	
Volkswagen	Polo	4 Cil, 1.6L	2003-2007	72275WS	F00E164933	5895WS	0986MF4612	82900WS	0986MF2900	
Volkswagen	Polo	4 Cil, 1.6L	2015-2020	80051WS	0986MF0051	84105WS	0986MF4105	82425WS	0986MF2425	
Volkswagen	Polo	4 Cil, 1.4L	2013-2014	80051WS	0986MF0051					
Volkswagen	Polo	4 Cil, 1.2L	2013-2014	80051WS	0986MF0051					
Volkswagen	R32	6 Cil, 3.2L	2003					77215WS	0986MF2318	
Volkswagen	Routan	6 Cil, 3.8L	2009-2010	80034WS	0986MF0034					
Volkswagen	Routan	6 Cil, 3.6L	2011-2012	80003WS	0986MF0003	84182WS	0986MF4182			
Volkswagen	Safari	4 Cil, 1.6L	1974-1980					77150WS	0986MF2057	
Volkswagen	Saveiro	4 Cil, 1.6L	2010-2020	72275WS	F00E164933	84104WS	0986MF4104	82426WS	0986MF2426	
Volkswagen	Sedan	4 Cil, 1.2L	1961-1967	80044WS / 80019WS*	0986MF0044 / 0986MF0019*					
Volkswagen	Sedan	4 Cil, 1.5L	1968-1972	80044WS / 80019WS*	0986MF0044 / 0986MF0019*					

		 									
Marca	Modelo	Motor	Año	Num. Corto	10 Dígitos	Num. Corto	10 Dígitos	Num. Corto	10 Dígitos		
Volkswagen	Sedan	4 Cil, 1.6L	1973-1992	80044WS / 80019WS*	0986MF0044 / 0986MF0019*	84226WS	0986MF4226				
Volkswagen	Sedan	4 Cil, 1.6L	1993-2004	80044WS / 80019WS*	0986MF0044 / 0986MF0019*	84226WS	0986MF4226	77131WS	0986MF2030		
Volkswagen	Sharan	4 Cil, 1.8L	2002-2008	80044WS / 80019WS*	0986MF0044 / 0986MF0019*			77131WS	0986MF2030		
Volkswagen	SportVan	4 Cil, 1.6L	2007-2010					82425WS	0986MF2425		
Volkswagen	Tiguan	4 Cil, 2.0L	2009-2017	80014WS	0986MF0014	84096WS	0986MF4096				
Volkswagen	Tiguan	4 Cil, 1.4L	2013-2018	80051WS	0986MF0051	84223WS	0986MF4223				
Volkswagen	Touareg	8 Cil, 4.2L	2004-2008			84220WS	0986MF4220				
Volkswagen	Touareg	6 Cil, 3.6L	2011-2017			84220WS	0986MF4220				
Volkswagen	Touareg	6 Cil, 3.2L	2004-2007			84220WS	0986MF4220				
Volkswagen	Touareg	6 Cil, 3.6L	2008-2009			84220WS	0986MF4220				
Volkswagen	Touareg	6 Cil, 3.0L	2013-2017			84220WS	0986MF4220	82425WS	0986MF2425		
Volkswagen	Transporter	4 Cil, 2.0L	2010-2018	80007WS	0986MF0007	5808WS	0986MF4007				
Volkswagen	Up!	3 Cil, 1.0L	2016-2018	80034WS	0986MF0034			82426WS	0986MF2426		
Volkswagen	Van	4 Cil, 1.8L	2003-2009	80044WS / 80019WS*	0986MF0044 / 0986MF0019*	5825WS	0986MF4116	77210WS	0986MF2280		
Volkswagen	Vento	4 Cil, 1.6L	2014-2021	80051WS	0986MF0051	84105WS	0986MF4105	82425WS	0986MF2425		
Volkswagen	Vento - Diesel	4 Cil, 1.5L	2016			84143WS	0986MF4143				
Volkswagen	Vento - Diesel	4 Cil, 1.5L	2018			84143WS	0986MF4143				
Volkswagen	Virtus	4 Cil, 1.6L	2020-2021			84219WS	0986MF4219				
Volvo	C70	5 Cil, 2.3L	1999-2001	80038WS	0986MF0038						
Volvo	C70	5 Cil, 2.4L	2002-2005	80038WS	0986MF0038						
Volvo	S40	4 Cil, 1.9L	1999-2004	80038WS	0986MF0038	84040WS	0986MF4040				
Volvo	S40	5 Cil, 2.5L	2004-2007			84191WS	0986MF4191				
Volvo	S60	5 Cil, 2.4L	2001-2003	80038WS	0986MF0038	84191WS	0986MF4191				
Volvo	S60	5 Cil, 2.0L	2001-2004	80038WS	0986MF0038						
Volvo	S60	5 Cil, 2.3L	2001-2005	80038WS	0986MF0038	84191WS	0986MF4191				
Volvo	S60	5 Cil, 2.5L	2004-2007	80038WS	0986MF0038	84191WS	0986MF4191				
Volvo	S60	5 Cil, 2.4L	2006-2008	80038WS	0986MF0038	84191WS	0986MF4191				
Volvo	S70	5 Cil, 2.3L	2000	80038WS	0986MF0038						
Volvo	S70	5 Cil, 2.4L	2000	80038WS	0986MF0038						

		 Cil.  CC		Filtro de aceite 		Filtro de aire 		Filtro de gasolina 	
Marca	Modelo	Motor	Año	Num. Corto	10 Dígitos	Num. Corto	10 Dígitos	Num. Corto	10 Dígitos
Volvo	S80	6 Cil, 2.8L	1999-2003						
Volvo	S80	6 Cil, 2.9L	2000-2006	80038WS	0986MF0038				
Volvo	S80	5 Cil, 2.5L	2005-2006	80038WS	0986MF0038				
Volvo	S80	8 Cil, 4.4L	2010	80038WS	0986MF0038				
Volvo	V40	4 Cil, 1.9L	1999-2004	80038WS	0986MF0038	84040WS	0986MF4040		
Volvo	V40	4 Cil, 2.0L	2014-2018	80038WS	0986MF0038				
Volvo	V70	5 Cil, 2.4L	2001-2003	80038WS	0986MF0038	84191WS	0986MF4191		
Volvo	V70	5 Cil, 2.4L	1999-2000	80038WS	0986MF0038				
Volvo	V70	5 Cil, 2.3L	2000-2003	80038WS	0986MF0038	84191WS	0986MF4191		
Volvo	XC70	5 Cil, 2.5L	2004-2007	80038WS	0986MF0038	84191WS	0986MF4191		
Volvo	XC90	6 Cil, 2.9L	2003-2006	80038WS	0986MF0038	84084WS	0986MF4084		
Volvo	XC90	5 Cil, 2.5L	2004-2007	80038WS	0986MF0038	84084WS	0986MF4084		
Volvo	XC90	8 Cil, 4.4L	2006-2010	80038WS	0986MF0038				
Volvo	XC90	5 Cil, 2.5L	2012-2014	80038WS	0986MF0038				



BOSCH

CATALOGO DE **BUJIAS INCANDESCENTES**

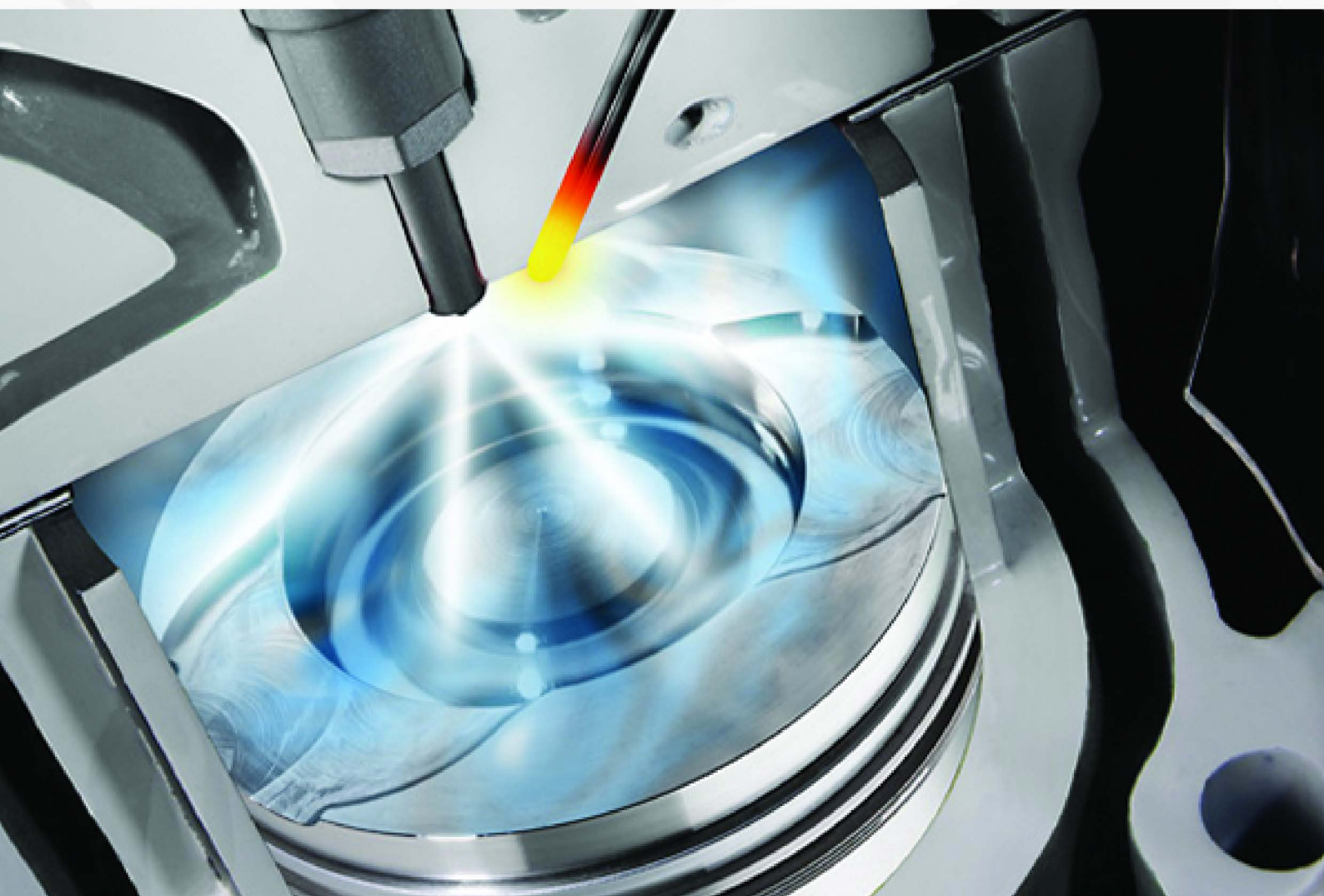



Explicación de la fórmula de tipo

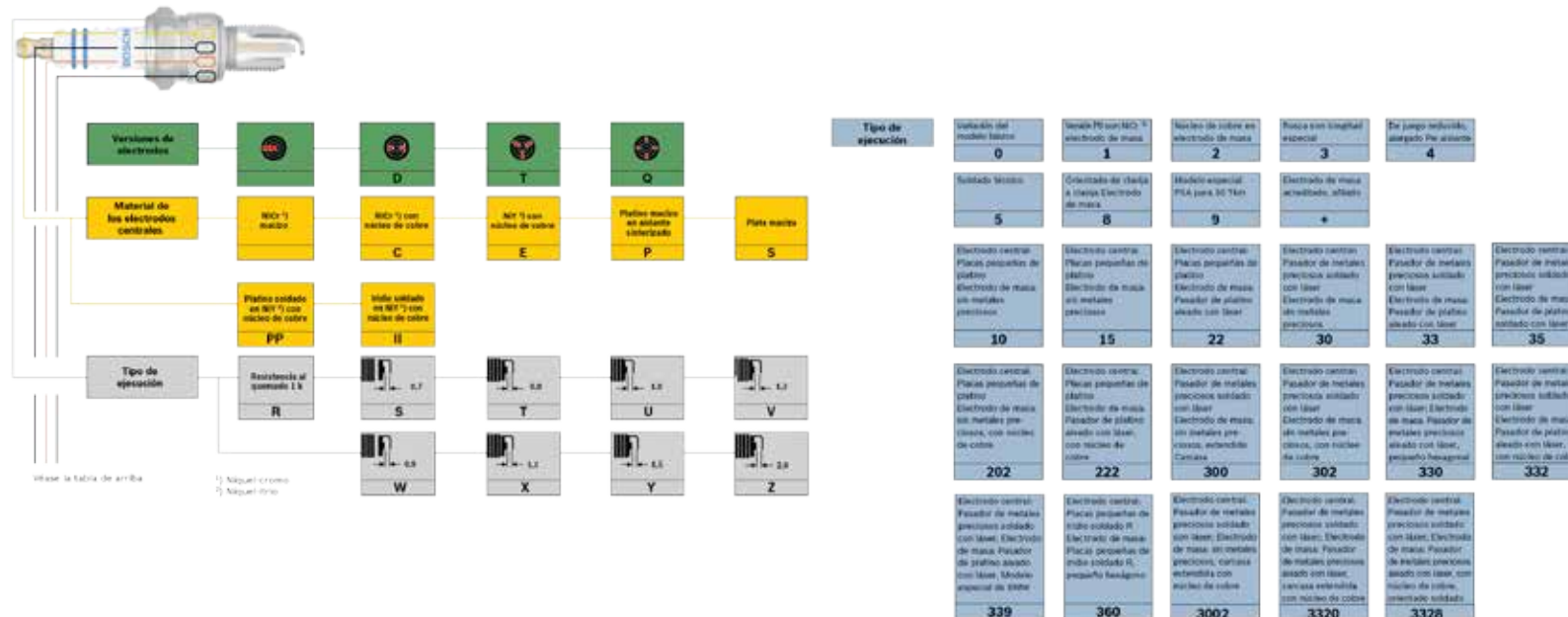
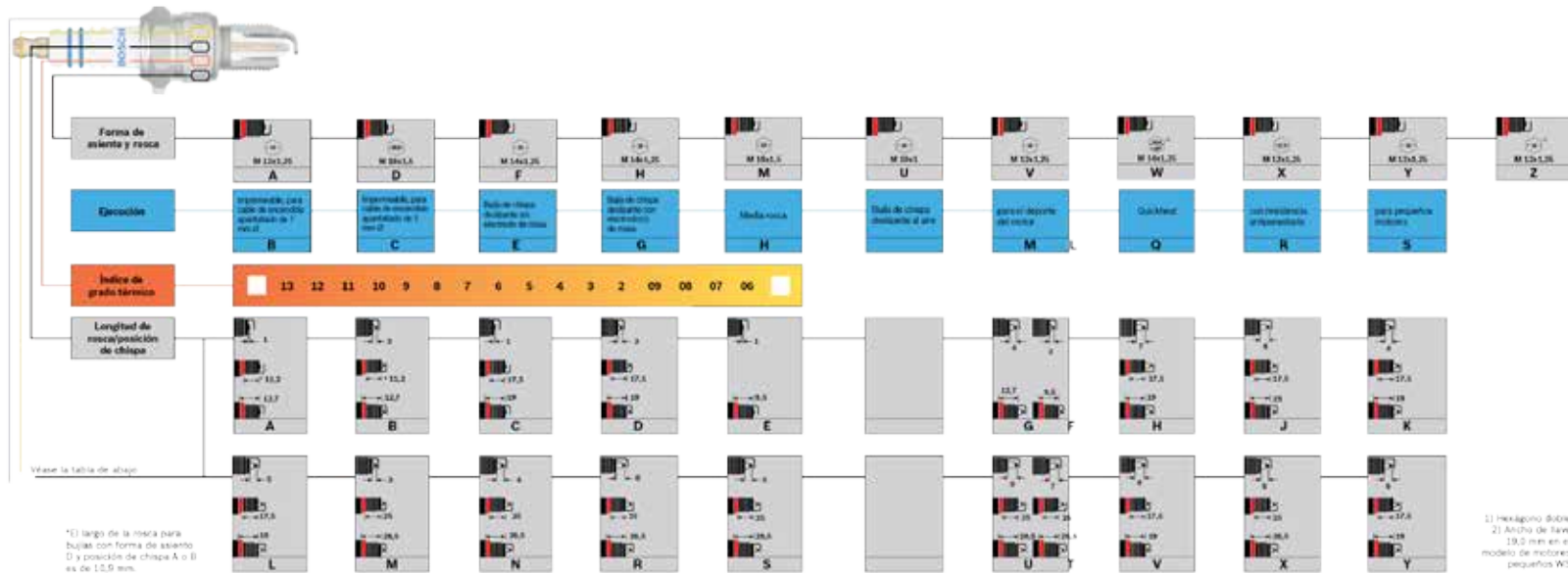



¿Cómo afecta la construcción de una bujía su desempeño?

Función

Introducir la energía producida por el sistema de encendido en la cámara de combustión, generando una chispa eléctrica entre sus electrodos, para iniciar la combustión de la mezcla aire/combustible que mueve los pistones, haciendo que el motor funcione. La bujía de encendido es también responsable de absorber el calor generado en la cámara de combustión y disiparlo, permitiendo que el motor trabaje siempre en la temperatura adecuada a su potencia.

- 1) Aislador de Piranite.** La parte más importante de la bujía. Está hecha de óxido de aluminio y aditivos vítreos para soportar hasta 30,000 volts y una temperatura operante de hasta 840°C. La conductividad térmica del aislador en este rango de temperatura es crucial para determinar el grado térmico de la bujía y su desempeño para diferentes condiciones de manejo.
- 2) Tuerca de conexión.** Permite y sirve como conexión entre el cable de bujía y el perno de conexión transmitiendo adecuadamente el flujo de potencia.
- 3) Perno de conexión.** Es la unión con el electrodo central y va unido al aislador.
- 4) Barrera contra fuga de corriente.** Estas nervaduras de cerámica sirven más que para solo identificación de la bujía. Están diseñados para evitar la fuga de voltaje; su forma geométrica y el número de barreras quintuple se oponen a este fenómeno.
- 5) Carcasa de acero, niquelada.** El acero es el material más común para las carcasas. La carcasa y el aislador son unidos mediante un proceso de retractilado eléctrico. Algunos fabricantes usan laminado con zinc, pero las carcasas Bosch son laminadas con níquel para evitar la oxidación.
- 6) Resistor de supresión (Masa vítrea).** El aseguramiento en este punto previene que los gases calientes de combustión escapen y quiten potencia al motor. Esta masa es hecha a base de una mezcla vítreo-grafito-metalizada para mantener una conductividad constante y operar en todo tipo de temperatura, además de que filtran corrientes parásitas.
- 7) Arandela de sellado (Vedamiento).** Al tener buen contacto con la culata del motor actúa como un disipador de calor.
- 8) Rosca niquelada.** Por su manufactura permite un deslizamiento suave y nos evita el agarrotamiento o gripado, especialmente, en las culatas de aluminio, a diferencia de las laminadas con zinc.
- 9) Pie del aislador.** Expuesto a la cámara de combustión.
- 10) Núcleo de cobre en electrodo central.** Electrodo de tierra cuando se requiere.
- 11) Electrodo central.** Para encendido más rápido y una aceleración más cómoda.
- 12) Electrodo masa.** El electrodo central y electrodo masa dan el espacio y permiten la calibración de la bujía para la chispa. Debido a que el electrodo de masa es expuesto a altas temperaturas y voltaje, su material y tamaño son extremadamente importantes.



Construcción/Componentes

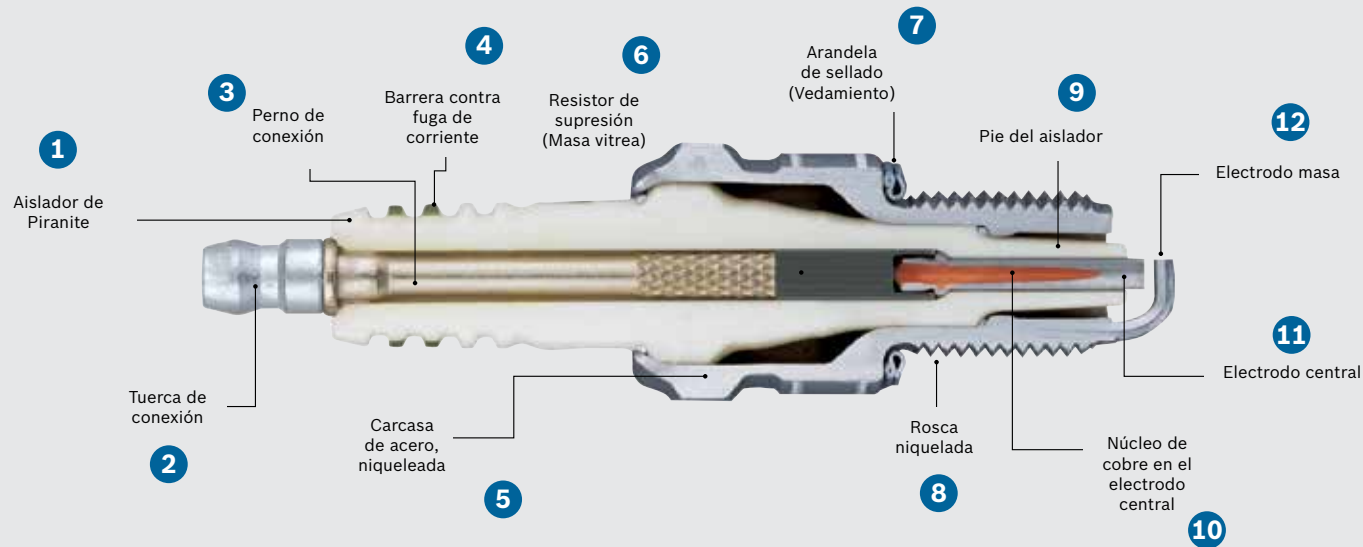

Componentes

El formato y la aleación del material del electrodo central y del electrodo masa determinan el tipo de bujía.





Grado Térmico

Los motores alcanzan temperaturas de trabajo distintas. Las bujías deben compensar esta variación para mantenerlos en temperatura adecuada a su necesidad. De esa manera ellas absorben y disipan el calor según la exigencia del motor. A esta capacidad damos el nombre de “grado térmico”. El tamaño y configuración del pie del aislador, además del material del electrodo, son las características que más influyen en la disipación del calor, que ocurre de la siguiente forma (ver abajo):

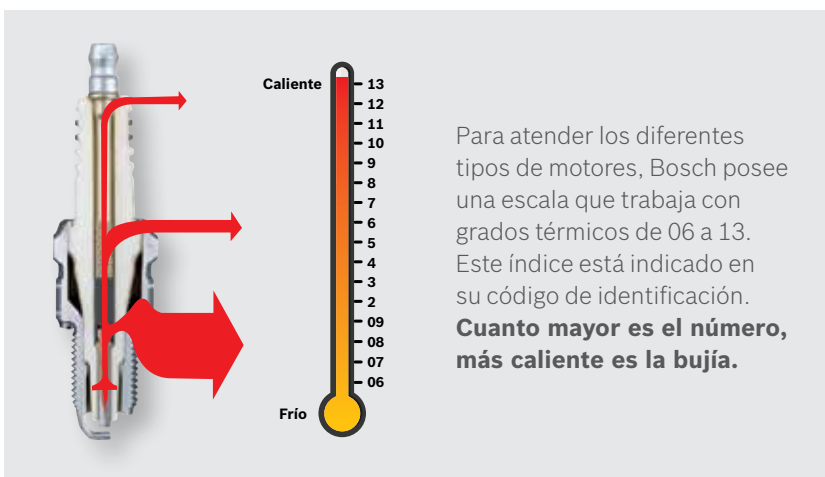

Para atender los diferentes tipos de motores, Bosch posee una escala que trabaja con grados térmicos de 06 a 13. Este índice está indicado en su código de identificación.
Cuanto mayor es el número, más caliente es la bujía.

Aplicaciones incorrectas



Bujía demasiado fría instalada en motor que exige bujía más caliente: fallas de encendido

Trabajando en baja temperatura, la bujía acumulará hollín en el pie del aislador, provocando fallas en el encendido e incluso impidiendo la formación de la chispa.



Bujía demasiado caliente instalada en motor que exige bujía más fría: encendido por incandescencia

La bujía puede sobrecalentarse y su contacto con la mezcla aire/combustible puede provocar el encendido por incandescencia, sobrecargando y dañando el motor.

Los motores más potentes y de mayor rendimiento trabajan con temperaturas muy altas y, por lo tanto, necesitan una bujía que disipe el calor de la cámara de combustión más rápidamente. **Bujía fría → grado térmico bajo.**

En cambio, los vehículos más tradicionales operan con temperaturas más bajas, por lo que requieren una bujía que haga la disipación de calor más lentamente. **Bujía caliente → grado térmico alto.**



Técnica de la chispa de bujías de encendido

Electrodo de cubierta – electrodo central.



Electrodo lateral – electrodo central.



Electrodo de masa perfilado – electrodo central.



Electrodo lateral – superficie de aislador – electrodo central.



Electrodo lateral – electrodo central o electrodo lateral – superficie de aislador – electrodo central.



Bujías de encendido con técnica de chispa al aire

La chispa de encendido salta directamente del electrodo central al de masa, atravesando la mezcla de aire y combustible que se encuentra entre ambos electrodos (fig. a, b, c).

Las ventajas:

- Gran seguridad de encendido durante toda la vida útil.
- Buen comportamiento de arranque en frío.
- Escasa demanda de tensión de encendido.

Los cantos vivos adicionales interiores que se forman con el perfil del electrodo de masa proporcionan, en combinación con el espacio ampliado entre los electrodos, una transmisión más sencilla y aún más efectiva de la energía térmica de la chispa a la mezcla de aire y combustible (fig. c).

Las ventajas:

- Gran seguridad de encendido por la rapidez con que salta la chispa y se inflama la mezcla.

- Seguridad adicional en el arranque en frío, también con una tensión de abordo baja.
- Mejor combustión, lo que protege el motor y, especialmente, el catalizador.
- Reducción adicional del consumo de combustible al evitar fallos de encendido.

Bujías de encendido con técnica de chispa deslizante

Los electrodos de masa están instalados por construcción de modo que puedan formarse exclusivamente chispas deslizantes al aire particularmente largas y potentes (fig. d).

Las ventajas:

- Mayor seguridad de encendido durante toda la vida útil.
- Protección óptima del catalizador.
- Demanda de tensión de encendido particularmente baja.
- Efecto de autolimpieza en caso de formación de hollín.
- Mayor vida útil por disposición de varios electrodos de masa.

Bujías de encendido con técnica de chispa deslizante al aire

La chispa de encendido elige la mejor vía para el encendido seguro desde el electrodo central hasta el electrodo de masa, ya sea como chispa al aire o como chispa deslizante al aire. En el encendido, la chispa al aire salta directamente del electrodo central al electrodo de masa. La chispa se desliza sobre portadores de carga presentes en la punta del pie del aislador y salta en forma de chispa al aire hacia el electrodo de masa (fig. e).

Las ventajas:

- Mayor seguridad de encendido durante toda la vida útil.
- Mejor comportamiento de arranque en frío.
- Escasa demanda de tensión de encendido.
- Efecto de autolimpieza en caso de formación de hollín.
- Protección óptima del catalizador.
- La disposición de varios electrodos de masa incrementa la vida útil.



Bujía Bosch Doble Iridio

Diseñada para proveer el más alto rendimiento y larga vida

Las bujías Bosch Iridio están diseñadas para ofrecer el más alto rendimiento y larga duración. El diseño de equipo original de Bosch, los materiales y los procesos de fabricación representan **lo mejor de la tecnología Bosch** en el mercado.

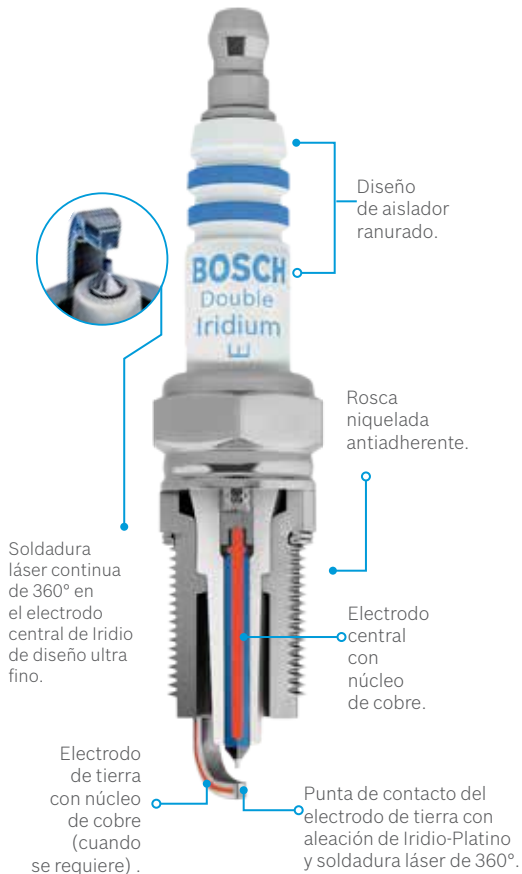

Tecnología de punta fina

El diseño de punta fina y el electrodo de masa cónico con soldadura láser de 360° ofrecen el más alto rendimiento, mientras que el electrodo central de iridio, también con soldadura láser de 360°, provee hasta 4 veces mayor duración que las bujías estándar de cobre.

Lo mejor de la tecnología de Equipo Original

Usted no tiene que escoger entre alto desempeño y larga duración en su bujía de Iridio. Bosch Iridio está diseñada para darle ambas. El diseño de equipo original Bosch, materiales y procesos, representan lo mejor de la tecnología. Mientras que el diseño de electrodo central ultra fino y electrodo de masa apuntado soldados con láser entregan el máximo desempeño, el electrodo central de iridio y el electrodo de masa con aleación de platino ayudan a ir más lejos. Libere el potencial de su motor con bujías Bosch Iridio.

Característica	Beneficio
Electrodo Central: <ul style="list-style-type: none"> Soldadura láser continua de 360° para fusionar la punta de Iridio Diseño ultra fino Núcleo de cobre 	<ul style="list-style-type: none"> Mejora la durabilidad Entrega un desempeño e ignición excepcionales Incrementa el rango de calentamiento para resistir pre-igniciones
Electrodo de masa: <ul style="list-style-type: none"> Forma apuntada Soldadura láser en la punta de Iridio con aleación de Platino Núcleo de cobre (cuando es requerido) 	<ul style="list-style-type: none"> Mejora la combustión y potencia Mejora la durabilidad Incrementa el rango de calentamiento para resistir pre-igniciones
Rosca niquelada antiadherente	Protección contra la corrosión y la adherencia
Aislador con diseño ranurado	Prevé contra falta de ignición
Garantía de desempeño por 7 años	Le da kilómetros de tranquilidad al manejar



Bujía Bosch Doble Platino

Diseñada para un alto rendimiento y larga vida

Las bujías Bosch Doble Platino fueron creadas para incrementar el desempeño y vida útil. El diseño de punta fina en el electrodo central mejora la ignición y desempeño en su motor, mientras que la punta de platino en el electrodo central y de tierra aseguran una larga duración.

Tecnología de punta fina

Las bujías de doble platino Bosch están diseñadas para una vida útil y durabilidad prolongadas. El diseño de punta fina del electrodo central mejora la ignición y el rendimiento de su motor, mientras la punta de platino del electrodo central y de tierra garantizan una mayor vida útil, logrando hasta 3 veces mayor durabilidad que las bujías estándar de cobre.

Tecnología de punta fina

Las bujías Bosch Doble Platino están diseñadas para incrementar el desempeño y la vida útil. El diseño de punta fina en el electrodo central mejora la ignición y desempeño en su motor, mientras que la punta de platino en el electrodo central y de masa aseguran una larga duración.



Característica	Beneficio
Electrodo Central:	
<ul style="list-style-type: none"> Soldadura láser continua de 360° para fusionar la punta de platino Diseño ultra fino Núcleo de cobre 	<ul style="list-style-type: none"> Mejora la durabilidad Entrega un desempeño e ignición excepcionales Incrementa el rango de calentamiento para resistir pre-igniciones
Electrodo de masa:	
<ul style="list-style-type: none"> Soldadura láser en la punta de Platino Núcleo de cobre (cuando se requiere) 	<ul style="list-style-type: none"> Mejora la durabilidad Incrementa el rango de calentamiento para resistir pre-igniciones
Rosca níquelada antiadherente	Protección contra la corrosión y la adherencia
Aislador con diseño ranurado	Prevé contra falta de ignición
Pre-calibrada	No necesita calibrarse para una rápida instalación



Bujía Bosch Platino

Diseñada para proporcionar un arranque y rendimiento mejorados

El diseño de equipo original, la tecnología de punta fina y soldadura láser de 360° ofrece un ajuste y funcionamiento ideales para una vida útil 2 veces mayor, en comparación con las bujías estándar de cobre.

Compare las características del producto y verá que Bosch Platino es la mejor opción para su vehículo.

Tecnología de punta fina

Las bujías Bosch Platino están diseñadas para ofrecer un mejor arranque y desempeño en su motor.

Tecnología OE Fine Wire

La tecnología OE Fine Wire entrega un diseño ideal y dos veces más de vida de servicio comparada con bujías de cobre convencionales. Con Bujías Bosch Platino su satisfacción y desempeño excepcional están garantizados.



Característica

Beneficio

Electrodo Central:

- Soldadura láser continua de 360° para fusionar la punta de platino
- Diseño ultra fino
- Núcleo de cobre

- Mejora la durabilidad
- Entrega un desempeño e ignición excepcionales
- Incrementa el rango de calentamiento para resistir pre-igniciones

Electrodo de masa:

- Forma cónica
- Itrio mejorado
- Núcleo de cobre (cuando es requerido)

- Mejora la combustión
- Mayor resistencia al desgaste
- Incrementa el rango de calentamiento para resistir pre-igniciones

Rosca niquelada antiadherente

Protección contra la corrosión y la adherencia

Aislador con diseño ranurado

Prevé contra falta de ignición

Garantía de desempeño por 4 años

Le da kilómetros de tranquilidad al manejar



Bujía Bosch Super 4

Innovadora técnica inteligente incluso para modelos antiguos

Bosch Super 4

Ofrece 4 electrodos de masa finos, con electrodo central con núcleo de cobre cubierto de plata y en forma de punta de flecha brindando 8 posibles recorridos diferentes de chispa pre-calibrados para su instalación más sencilla.

Ventajas técnicas:

1.-Chispa al aire

La chispa enciende la mezcla aire/combustible en el recorrido directo entre el electrodo central y el electrodo de masa.

2.-Chispa deslizante

En la chispa deslizante, ésta se desplaza a través del aislador entre el electrodo central y de masa, buscando siempre el recorrido más corto. Es decir, la distancia entre los electrodos aumenta demasiado por el desgaste natural, de manera que el recorrido a través del aislador es más corto, transformándose de bujía de chispa al aire a una de chispa deslizante. Su principal ventaja consiste en quemar las partículas de hollín depositadas en el pie del aislador (como residuos de la combustión) reduciendo así el peligro de derivaciones eléctricas.

Característica

- Mayor energía a la mezcla
- Rendimiento de la bujía superior al 60%
- Tres veces mejor arranque en frío que las normales
- Mayor seguridad de encendido
- Mayor aceleración y elasticidad del motor

Beneficio

- Mayor aceleración y suavidad de marcha
- Mejor aprovechamiento del combustible y eficiencia del motor
- Más seguridad al alcanzar en 0.4 seg 12 km/h en una distancia de 13.3 metros. En carretera esta puede ser una diferencia determinante en el rebase de automóviles y en pendientes
- Programa reducido único, con alta cobertura de mercado, al ser termo elásticas con aplicaciones a mayor número de automóviles, es decir, 1 tipo puede cubrir 2 grados térmicos
- Manipulación simple, almacenamiento más sencillo y alto índice de rotación





Bujía Bosch Super & Super Plus [Níquel]

Rendimiento óptimo en las condiciones de funcionamiento más adversas

Bosch Super

Las Bujías Bosch Super tienen un electrodo central compuesto con núcleo de cobre, supresor de interferencias y electrodo de masa superdimensionado. Se clasifican en: BOSCH SUPER DTC de tres electrodos de masa, electrodo central de níquel-cromo con núcleo de cobre y BOSCH SUPER LDC posición de chispa perfectamente dimensionado, 2 electrodos de masa, longitud de rosca de 19 mm, con electrodo central de níquel-cromo con núcleo de cobre.

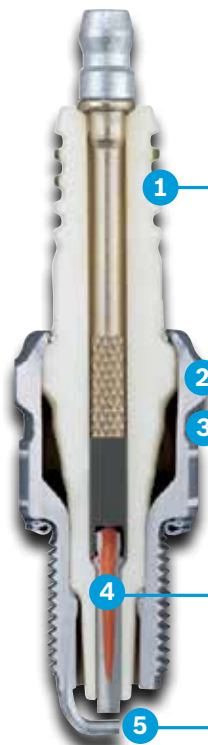

(1) Barrera quintuple contra corriente de fuga.

Impiden los picos de tensión y con ello las fallas de encendido.

(2) Cuerpo de bujía y rosca níquelada. Para la protección contra la corrosión, la oxidación y el agarrotamiento de la rosca en la culata de aluminio.

(3) Montaje de contracción en caliente. Garantiza la estanqueidad de los gases y un grado térmico exacto.

(4) Electrodo central. Compuesto de un núcleo de cobre como conductor térmico recubierto de níquel-cromo. Acelera la disipación del calor, impide fallos de encendido y proporciona mayor intervalo térmico de trabajo. La parte que penetra en la cámara de combustión está configurada de acuerdo al tipo de chispa que se produce y a la ejecución de los electrodos de masa.

(5) Electrodo de masa. La disposición, su número y su geometría influyen en la técnica de la bujía de encendido y con ello su vida útil.



Bosch Super Plus

El electrodo central con una aleación de itrio y su electrodo de masa perfilado en forma de punta, permite un encendido seguro, ya que está sometido a un menor desgaste que el electrodo central. Estas ventajas se pueden aprovechar así durante toda la vida útil de la bujía de encendido teniendo como beneficio:

- Mayor seguridad de encendido al producirse con mayor rapidez el salto de la chispa
- de encendido y la inflamación de la mezcla
- Seguridad adicional en el arranque en frío, también con un bajo voltaje para el encendido
- Mejor combustión, con mejor protección del motor y especialmente del catalizador
- Gran reducción de consumo de combustible al evitar fallos de encendido

Ventajas técnicas

- En comparación con los electrodos centrales estándar, se alcanza una mejor conductividad térmica, con tolerancia superior a la corrosión y alta resistencia al desgaste.

Beneficios

- Aprovechamiento total del combustible desde el arranque, además de soportar correctamente los altos voltajes y sobrecargas.



Análisis del estado de las bujías de encendido

1 + 2 Normal

Pie del aislador de color blanco o amarillo grisáceo hasta pardo corzo. El motor está a punto. Se ha elegido el grado térmico correcto. El ajuste de la mezcla y del encendido son perfectos, no hay fallos de encendido, el sistema de arranque en frío funciona. No hay residuos de aditivos del combustible que contengan plomo ni de componentes de aleación del aceite del motor. No existe sobrecarga térmica.

3 + 4 Bujía cubierta de hollín

Pie del aislador, electrodos y cuerpo de la bujía cubiertos de hollín de color negro mate y aspecto aterciopelado.

Causa: ajuste incorrecto de la mezcla (carburador, inyección): mezcla demasiado rica, filtro del aire muy sucio, dispositivo automático de arranque defectuoso o el cable de mando del estrangulador se ha estirado demasiado, recorridos predominantemente cortos, bujía demasiado fría, índice del grado térmico demasiado bajo.

Repercusiones: fallos del encendido, mal comportamiento de arranque en frío.

Remedio: ajustar correctamente la mezcla y el dispositivo de arranque, revisar el filtro del aire.

5 + 6 Bujía engrasada

Pie del aislador, electrodos y cuerpo de la bujía cubiertos de hollín aceitoso brillante o de carbonilla.

Causa: demasiado aceite en la cámara de combustión. Excesivo nivel de aceite, segmentos de pistón, cilindros y guías de válvulas muy desgastados. En motores de gasolina de dos tiempos, demasiado aceite en la mezcla.

Repercusiones: fallos del encendido, mal comportamiento de arranque.

Remedio: revisar el motor, emplear una mezcla correcta de combustible y aceite, montar nuevas bujías de encendido.

7 Ferroceno

Pie del aislador, electrodos y en parte cuerpo de la bujía cubiertos de sedimentos rojos-naranja firmemente adheridos.

Causa: aditivos del combustible con contenido de hierro. Los sedimentos se forman durante el funcionamiento normal después de unos pocos miles de kilómetros.

Repercusiones: la capa con contenido de hierro es eléctricamente conductiva y provoca fallos del encendido.

Remedio: montar bujías de encendido nuevas; limpiarlas resulta inútil.

8 Depósitos de plomo

El pie del aislador presenta en algunos puntos una vitrificación pardo-amarillenta, que puede adoptar una coloración verdosa.

Causa: aditivos con plomo en el combustible. La vitrificación se forma al someter el motor a una carga elevada después de haber funcionado largo tiempo a carga parcial.

Repercusiones: con cargas elevadas, la capa se torna electro-conductora y causa fallos del encendido.

Remedio: montar bujías de encendido nuevas; limpiarlas resulta inútil.

9 + 10 Grandes depósitos de plomo

El pie del aislador presenta en algunos puntos una gruesa vitrificación pardo-amarillenta, que puede adoptar una coloración verdosa.





Análisis del estado de las bujías de encendido

Causa: aditivos con plomo en el combustible. La vitrificación se forma al someter el motor a una carga elevada después de haber funcionado largo tiempo a carga parcial.

Repercusiones: con cargas elevadas, la capa se torna electroconductora y causa fallos del encendido.

Remedio: montar bujías de encendido nuevas; limpiarlas resulta inútil.

11 + 12 Formación de ceniza

Gruesa capa de ceniza proveniente de aditivos del aceite y del combustible, depositada sobre el pie del aislador, en el espacio de ventilación (rendija anular) y sobre el electrodo de masa. Estructura entre suelta y semejante a la escoria.

Causa: componentes de aleación, procedentes especialmente del aceite, pueden depositar esta ceniza en la cámara de combustión y sobre la cara de la bujía.

Repercusiones: puede causar autoencendido con pérdida de potencia e incluso daños en el motor.

Remedio: poner el motor a punto. Montar bujías nuevas, emplear eventualmente otro aceite.

13 Electrodo central parcialmente fundido

Electrodo central parcialmente fundido, punta del pie del aislador cubierta de burbujas, esponjosa y reblandecida.

Causa: sobrecarga térmica debida, por ejemplo, a un ajuste demasiado avanzado del punto de encendido, residuos de combustión en la cámara de combustión, válvulas defectuosas, distribuidor de encendido deteriorado y combustible de calidad insuficiente.

Repercusiones: fallos del encendido, pérdida de potencia (daños en el motor).

Remedio: revisar el motor, el encendido y la preparación de la mezcla. montar bujías nuevas con el grado térmico correcto.

14 Electrodo central completamente fundido

Electrodo central completamente fundido; al mismo tiempo, electrodo de masa muy deteriorado.

Causa: sobrecarga térmica debida, por ejemplo, a un ajuste demasiado avanzado del punto de encendido, residuos de combustión en la cámara de combustión, válvulas defectuosas, distribuidor de encendido deteriorado y combustible de calidad insuficiente.

Repercusiones: fallos de encendido, pérdida de potencia, eventuales daños en el motor. Se puede agrietar el pie del aislador debido a sobrecalentamiento del electrodo central.

Remedio: revisar el motor, el encendido y la preparación de la mezcla. Montar nuevas bujías de encendido.

15 Electrodo central parcialmente fundido

Electrodos con aspecto de coliflor. Posible precipitación de sustancias ajenas a la bujía.





Análisis del estado de las bujías de encendido

Causa: sobrecarga térmica debida, por ejemplo, a un ajuste demasiado avanzado del punto de encendido, residuos de combustión en la cámara de combustión, válvulas defectuosas, distribuidor de encendido deteriorado y calidad insuficiente del combustible.

Repercusiones: antes del fallo total (daños en el motor), se produce pérdida de potencia.

Remedio: revisar el motor, el encendido y la preparación de la mezcla. Montar nuevas bujías de encendido.

16 Fuerte desgaste del electrodo central

Causa: las bujías de encendido no se han cambiado en el intervalo previsto.

Repercusiones: fallos de encendido, especialmente al acelerar (la tensión de encendido ya no es suficiente para compensar la gran separación de los electrodos). Mal comportamiento de arranque.

Remedio: montar nuevas bujías de encendido.

17 Fuerte desgaste del electrodo de masa

Causa: aditivos agresivos del combustible y del aceite. Condiciones de flujo desfavorables en la cámara de combustión, debidas eventualmente a depósitos, picado del motor. No existe sobrecarga térmica.

Repercusiones: fallos de encendido, especialmente al acelerar (la tensión de encendido ya no es suficiente para compensar la gran separación de los electrodos). Mal comportamiento de arranque.

Remedio: montar nuevas bujías de encendido.

18 Rotura del pie del aislador

Causa: daños de origen mecánico debidos a golpe, caída o presión sobre el electrodo central por manipulación inadecuada. En casos extremos, debido a depósitos entre el electrodo central y el pie del aislador y a corrosión del electrodo central se puede romper el pie del aislador, especialmente en caso de funcionamiento demasiado prolongado.

Repercusiones: fallos del encendido, la chispa de encendido salta en puntos a los que la mezcla.





Dudas más frecuentes

1. ¿Cuánto tiempo dura una bujía? ¿Cuándo debe ser hecho su cambio?

R: La vida útil de una bujía depende de sus características, o sea, tipo de material y cantidad de electrodos, además del tipo de combustible utilizado por el vehículo.

Lo correcto es seguir la recomendación del fabricante del vehículo, especificada en el manual del propietario.

2. ¿Cuál es la bujía correcta para el vehículo?

R: Para identificar la bujía correcta, es necesario consultar el catálogo de aplicación de bujías de Bosch o el manual del propietario del vehículo.

3. La bujía posee una parte de cerámica. ¿Esta parte es frágil? ¿Puede romperse e influir en el funcionamiento de la bujía?

R: El aislador (cerámica) es extremadamente resistente a elevadas temperaturas, gases de la combustión, choque térmico y alta tensión. Es muy raro que ocurra, pero cuando ocurre la

rajadura es generalmente en función de la utilización de herramienta inadecuada en la instalación de la bujía en el motor del vehículo o cuando sufre caídas o golpes.

4. Cuando el motor del vehículo falla, ¿normalmente es por culpa de las bujías?

R: No, en general eso ocurre cuando el motor tiene deficiencias en los sistemas de encendido y alimentación de combustible y por lo tanto la combustión no se realiza como el motor necesita (combustión incompleta), lo que se nota en el funcionamiento de las bujías de encendido.

5. ¿Al instalar una bujía nueva se debe lubricar la rosca?

R: No, pues la rosca es niquelada justamente para evitar que se agarre a la culata; además ella viene lubricada con un aceite especial de la fábrica. Si le ponen una grasa cualquiera, con la variación de la temperatura del motor, la grasa puede derretirse y la bujía agarra a la culata, dificultando su retirada.

6. ¿La bujía se debe calibrar antes de ser instalada en el motor?

R: La bujía ya viene pre ajustada de fábrica, pero puede ocurrir que cuando el mecánico vaya a instalarla, ésta se le escape de las manos y se vaya al suelo, cerrando la separación entre electrodos. Por lo tanto, siempre se recomienda averiguar la distancia antes de instalar.



Identificando problemas

El funcionamiento de las bujías puede ser perjudicado por varios factores externos:

- Utilización de bujía inadecuada al modelo del vehículo.
- Mala regulación del sistema de encendido.
- Mala instalación, llave inadecuada.
- Ajuste de la distancia de los electrodos hecho de manera inadecuada.
- Cables de encendido dañados.
- Combustible inadecuado.
- Motor quemando aceite.
- Filtro de aire sucio.

Por eso, es siempre importante verificar la existencia de problemas que pueden estar influyendo en el desempeño de las bujías, así como ponerse en contacto con el equipo técnico profesional Bosch.



Montaje de las Bujías

	①	②
M 10 x1	10...15	10...15
M 12 x1,25	15...25	15...20
M 14 x1,25 l < 12,7 mm	20...25	15...20
M 14 x1,25 l > 12,7 mm	20...40	20...30
M 18 x1,5	30...45	20...35

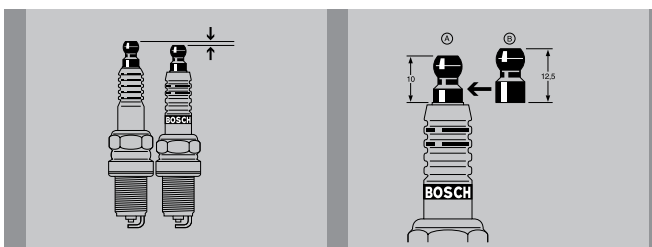
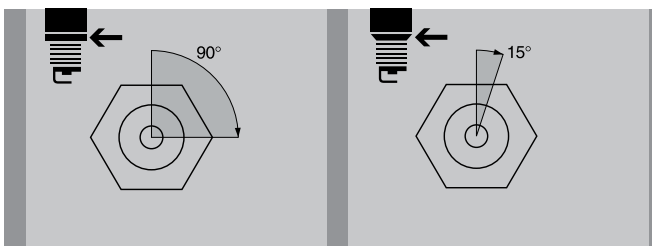

Montaje correcto de la bujía con llave dinamométrica:

Par de apriete (N • m): 10 N • m ≈ 1 kpm

Observar:

Los pares de apriete mencionados son válidos para roscas secas, no lubricadas con grasa ni aceite y para anillos obturadores nuevos.

En el caso de roscas lubricadas o si se vuelve a montar una bujía, los pares de apriete indicados deben reducirse en 1/3.

1. En hierro colado
1. En aleación ligera

Montaje correcto de la bujía de encendido sin llave dinamométrica:

Observar:

Enroscar con la mano la bujía de encendido hasta que haga tope en la culata.

Las bujías de encendido con asiento plano y una nueva junta se giran aproximadamente 90 grados más con la llave de bujías. Las bujías de encendido con asiento cónico y anillo obturador plano continúan girándose aprox. 15 grados más.

Tuercas de conexión de bujías de encendido

Observar:

En el motor pueden estar montadas bujías que en su longitud difieran de las bujías de encendido Bosch.

1. Desenroscar las bujías de encendido viejas.
2. Compararlas con bujías de encendido Bosch nuevas.
3. Si la bujía de encendido a sustituir es más larga que la bujía Bosch, reemplazar la tuerca de conexión enroscada A por la tuerca B adjuntada, más larga.

¡A tener en cuenta!

Las recomendaciones de bujías de encendido han sido establecidas por Bosch, siempre y cuando no procedan del fabricante del vehículo o del motor. Las bujías de encendido recomendadas rigen para condiciones de servicio normales en modelos de serie, pero no para ejecuciones de competición, especiales y de alto rendimiento, a no ser que se indiquen de forma especial tales modelos.

El uso de otros grados térmicos distintos a los recomendados puede ser necesario por condiciones especiales de servicio. Separación específica entre electrodos. Si no hay bujías disponibles con la separación específica entre electrodos, será necesario reajustar la separación entre los mismos.

Marca / Modelo	Motor	Años	Doble Iridio		Iridio		Doble Platino		Platino		Super 4		Níquel	
			Fórmula	Nº. de Parte	Fórmula	Nº. de Parte	Fórmula	Nº. de Parte	Fórmula	Nº. de Parte	Fórmula	Nº. de Parte	Fórmula	Nº. de Parte

ACURA

ILX	L4 2.0L	2013-2015	YR7SII3520X*	0242135557*										
	L4 2.4L	2016-2020	VR6NII352U*	0242140555*										
MDX	V6 3.5L	2014-2020	YR7SII3520X*	0242135557*										
		2005-2006	FR7LII33X	0242236592			FR7LPP33X	0242236626	FR7LPP30X	0242236614				
	V6 3.7L	2010-2013	YR6SII330X	0242140523										
2007-2009		FR6LII330X	0242240675			FR6LPP330X	0242240687	FR6LPP300X	0242240683					
RDX	V6 3.5L	2013-2018	YR6SII330X	0242140523										
RL	V6 3.5L	2005-2008	FR6LII330X	0242240675			FR6LPP330X	0242240687	FR6LPP300X	0242240683				
	V6 3.7L	2009-2011	YR6SII330X	0242140523										
RLX	V6 3.5L	2014-2015	YR7SII3520X*	0242135557*										
TL	V6 3.2L	2005-2008	FR6LII330X	0242240675			FR6LPP330X	0242240687	FR6LPP300X	0242240683				
		2012-2013	YR7SII3520X*	0242135557*										
	V6 3.5L	2009-2011	YR6SII330X	0242140523										
TLX	L4 2.4L	2015-2019	VR6NII352U*	0242140555*										
		2018-2020	VR6NII352U*	0242140555*										
	V6 3.5L	2015-2019	YR7SII3520X*	0242135557*										
TSX	L4 2.4L	2009-2013	YR6SII330X	0242140523										
	V6 3.5L	2011-2013	YR6SII330X	0242140523										
ZDX	V6 3.7L	2010-2011	YR6SII330X	0242140523										

ALFA ROMEO

166	V6 3.0L	2002-2003			FR5KI332S	0242245571								
4C	L4 1.7L	2016-2017	VR6NII332	0242140557										
Brera	V6 3.2L	2007-2008						HR7MPP302X	0242235767					
Giulietta	L4 1.7L	2014-2019	VR6NII332	0242140557										
GT	L4 2.0L	2007-2008			FR6KI332S	0242240653		FR7DPP30T	0242236618	FR78	0242232501	FR7DC+	0242235666	
	V6 3.2L	2007-2007			FR5KI332S	0242245571								
GTV	V6 3.0L	2003-2003			FR5KI332S	0242245571								
Spider	V6 3.2L	2007-2008						HR7MPP302X	0242235767					
Sportwagon	L4 2.0L	2002-2002			FR6KI332S	0242240653		FR7DPP30T	0242236618	FR78	0242232501	FR7DC+	0242235666	



Marca / Modelo	Motor	Años	Doble Iridio		Iridio		Doble Platino		Platino		Super 4		Níquel	
			Fórmula	Nº. de Parte	Fórmula	Nº. de Parte	Fórmula	Nº. de Parte	Fórmula	Nº. de Parte	Fórmula	Nº. de Parte	Fórmula	Nº. de Parte
A4 Quattro	V6 2.8L	1997-2001											FGR7DQE+	0242235748
		1997-1998											FR7LDC+	0242235668
		1997-1997	FR7DII33X	0242236596			FR8DPP33X	0242230579			FR78X	0242232502		
	V6 3.2L	2005-2008											FGR7KQE0	0242235715
A5	L4 2.0L	2018-2019					FQ5NPP332S	0241245673						
		2012-2013					FR5KPP332S	0242245576						
	V6 3.0L	2015-2016					FR5KPP332S	0242245576						
A5 Quattro	L4 2.0L	2011-2013					FR5KPP332S	0242245576						
A5 Sportback	L4 2.0L	2019-2019					FQ5NPP332S	0241245673						
A6	L4 2.0L	2013-2014					FR5KPP332S	0242245576						
	V6 2.8L	2009-2011					FR7KPP332	0242235776						
		1998-2001	FR6KII33X	0242240669									FGR7DQE+	0242235748
		1998-1998											FR7LDC+	0242235668
	V6 3.0L	2005-2006					FR7KPP332	0242235776						
		2002-2004	FR7DII33X	0242236596					FR7DPP30X	0242236616				
	V6 3.2L	2009-2009					FR7KPP332	0242235776						
2006-2009								FR7DPP30X	0242236616					
A6 Quattro	L4 2.0L	2018-2018					FQ5NPP332S	0241245673						
	V6 2.8L	1998-2001	FR6KII33X	0242240669									FGR7DQE+	0242235748
		1998-1998											FR7LDC+	0242235668
	V6 3.0L	2010-2017					FR5KPP332S	0242245576						
		2005-2006					FR7KPP332	0242235776						
	V6 3.2L	2002-2004	FR7DII33X	0242236596					FR7DPP30X	0242236616				
		2006-2009							FR7DPP30X	0242236616			FGR7KQE0	0242235715
V8 4.2L	2005-2011											FGR7KQE0	0242235715	
A7	V6 3.0L	2016-2016					FR5KPP332S	0242245576						
A7 Quattro	V6 3.0L	2012-2017					FR5KPP332S	0242245576						
A8	V6 3.0L	2015-2016					FR5KPP332S	0242245576						
	V8 3.7L	2000-2000											FR6DC+	0242240593
Quattro	V6 3.0L	2013-2019					FR5KPP332S	0242245576						
	V8 4.2L	2006-2006	FR6KII33X	0242240669									FGR7KQE0	0242235715
		2001-2006											HGR7KQC	0242235607
		1997-1999												



A

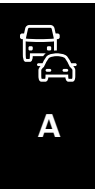

Marca / Modelo	Motor	Años	Doble Iridio		Iridio		Doble Platino		Platino		Super 4		Níquel	
			Fórmula	Nº. de Parte	Fórmula	Nº. de Parte	Fórmula	Nº. de Parte	Fórmula	Nº. de Parte	Fórmula	Nº. de Parte	Fórmula	Nº. de Parte
Allroad Quattro	V6 2.7L	2003-2004					FR7KPP33+	0242236564						
		2002-2004									FR78	0242232501		
Cabriolet	V6 2.8L	1997-1998	FR7DII33X	0242236596			FR8DPP33X	0242230579					FR7LDC+	0242235668
Q3	L4 2.0L	2013-2015					FR5KPP332S	0242245576						
Q5	V6 3.0L	2017-2017					FR5KPP332S	0242245576						
	V6 3.2L	2010-2012	FR8KII33X	0242230528			FR8DPP33X	0242230579	FR8DPP30X	0242230557				
Q7	V6 3.0L	2011-2019					FR5KPP332S	0242245576						
	V6 3.6L	2007-2010	YR6TII330T	0242140528										
R8	V10 5.2L	2011-2017					FR5KPP332S	0242245576						
	V8 4.2L	2009-2016					FR5KPP332S	0242245576						
		2008-2010											FGR7KQE0	0242235715
RS5	V8 4.2L	2011-2016					FR5KPP332S	0242245576						
RS6	V10 5.0L	2010-2010					FR6KPP332S	0242240627						
S3	L4 1.8L	2000-2004					FR7KPP33+	0242236564						
		2000-2003									FR78	0242232501		
	L4 2.0L	2017-2018					FQ5NPP332S	0241245673						
S4	V6 3.0L	2010-2013					FR5KPP332S	0242245576						
	V8 4.2L	2004-2008											FGR7KQE0	0242235715
S5	V6 3.0L	2016-2016					FR5KPP332S	0242245576						
	V8 4.2L	2008-2011			FR6K1332S	0242240653								
		2008-2008											FGR7KQE0	0242235715
S6	V8 4.2L	2001-2004											FGR6KQE	0242240587
S8	V8 4.2L	2001-2002											FGR7KQE0	0242235715
SQ5	V6 3.0L	2017-2017					FR5KPP332S	0242245576						
TT	L4 1.8L	2016-2016					FQ5NPP332S	0241245673						
		2011-2014					FR5KPP332S	0242245576						
		2000-2006									FR78	0242232501		
		1999-2006					FR7KPP33+	0242236564						
	1999-1999									FR78X	0242232502	FR6DC+	0242240593	
	L4 2.0L	2016-2016						FQ5NPP332S	0241245673					
2010-2010							FR6KPP332S	0242240627						
2007-2014							FR5KPP332S	0242245576						

Marca / Modelo	Motor	Años	Doble Iridio		Iridio		Doble Platino		Platino		Super 4		Níquel	
			Fórmula	Nº. de Parte	Fórmula	Nº. de Parte	Fórmula	Nº. de Parte	Fórmula	Nº. de Parte	Fórmula	Nº. de Parte	Fórmula	Nº. de Parte
TT Quattro	L4 1.8L	2014-2014					FR5KPP332S	0242245576						
		2000-2006					FR7KPP33+	0242236564			FR78	0242232501		
	L4 2.0L	2017-2018					FQ5NPP332S	0241245673						
		2014-2014					FR5KPP332S	0242245576						
TTS Quattro	V6 3.2L	2007-2009					YR7LPP332W	0242135510						
		L4 2.0L	2017-2018					FQ5NPP332S	0241245673					
			2010-2014					FR5KPP332S	0242245576					

BMW







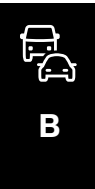

118i	L4 1.6L	2012-2015			ZR5SI332	0242145537								
120i	L4 1.6L	2016-2016			ZR5SI332	0242145537								
	L4 2.0L	2005-2012					FR7KPP332	0242235776						
128i	L6 3.0L	2013-2013					FR7NPP332	0242236510	FR7SPP302U	0242236653				
130i	L6 3.0L	2006-2009					FR7NPP332	0242236510						
135i	L6 3.0L	2012-2013					ZR5TPP33	0242145515						
235i	L6 3.0L	2014-2014					ZR5TPP33	0242145515						
320i	L4 2.0L	2014-2018					ZR5TPP330	0242145541						
	L6 2.2L	2001-2005							FGR7DQP+	0242236562				
323i	L6 2.5L	1999-2001							FGR7DQP+	0242236562				
		1997-1997					FR7DPP33X	0242236631	FR7DPP30T	0242236618	FR78X	0242232502	FR7LDC+	0242235668
323ti	L6 2.5L	1999-2000					FR7DPP33X	0242236631	FR7DPP30T	0242236618	FR78X	0242232502	FR7LDC+	0242235668
325Ci	L6 2.5L	2001-2006							FGR7DQP+	0242236562				
325i	L6 2.5L	2001-2005							FGR7DQP+	0242236562				
		1995-1997					FR7DPP33X	0242236631						
	L6 3.0L	2011-2013										ZGR6STE2	0242140507	
328i	L6 2.8L	1999-2000							FGR7DQP+	0242236562				
		1996-1998							FR8DPP30T	0242230572			FLR8LDCU+	0242229654
	L6 3.0L	2012-2013					ZR5TPP330	0242145541						
330Ci	L6 3.0L	2001-2006						FGR7DQP+	0242236562					
330e	L4 2.0L	2017-2018					ZR5SPP3320	0242145555						
330i	L4 2.0L	2017-2019					ZR5SPP3320	0242145555						
	L6 3.0L	2001-2005							FGR7DQP+	0242236562				
335i	L6 3.0L	2012-2015					ZR5TPP33	0242145515						



A
B



Marca / Modelo	Motor	Años	Doble Iridio		Iridio		Doble Platino		Platino		Super 4		Níquel	
			Fórmula	Nº. de Parte	Fórmula	Nº. de Parte	Fórmula	Nº. de Parte	Fórmula	Nº. de Parte	Fórmula	Nº. de Parte	Fórmula	Nº. de Parte
335i	L6 3.0L	2007-2010											ZGR6STE2	0242140507
340i	L6 3.0L	2016-2018					ZR5SPP3320	0242145555						
430i	L4 2.0L	2017-2019					ZR5SPP3320	0242145555						
430i Gran Coupe	L4 2.0L	2018-2019					ZR5SPP3320	0242145555						
435i	L6 3.0L	2014-2016					ZR5TPP33	0242145515						
435i Gran Coupe	L6 3.0L	2015-2016					ZR5TPP33	0242145515						
440i	L6 3.0L	2017-2019					ZR5SPP3320	0242145555						
440i Gran Coupe	L6 3.0L	2018-2019					ZR5SPP3320	0242145555						
525i	L6 2.5L	2001-2003							FGR7DQP+	0242236562				
528i	L6 2.8L	1999-2000							FGR7DQP+	0242236562				
		1999-1999											FR7LDC+	0242235668
		1997-1998							FR8DPP30T	0242230572			FLR8LDCU+	0242229654
	L6 3.0L	2011-2011						FR7SPP302U	0242236653					
530e	L4 2.0L	2018-2019					ZR5SPP3320	0242145555						
530i	L6 3.0L	2017-2019					ZR5SPP3320	0242145555						
		2010-2010											ZGR6STE2W	0242140560
		2006-2010					FR7NPP332	0242236510						
		2001-2005						FGR7DQP+	0242236562					
535i	L6 3.0L	2011-2016					ZR5TPP33	0242145515						
535i GT	L6 3.0L	2013-2013					ZR5TPP33	0242145515						
540i	V8 4.4L	2018-2019					ZR5SPP3320	0242145555						
		1999-2003							FGR7DQP+	0242236562				
		1997-2003	FR7DII33X	0242236596			FR7DPP33X	0242236631			FR78X	0242232502	FR7LDC+	0242235668
545i	V8 4.4L	2004-2006							FGR7DQP+	0242236562				
550i	V8 4.4L	2013-2013						ZR5TPP33	0242145515					
	V8 4.8L	2006-2010						FR7KPP332	0242235776					
640i Gran Coupe	L6 3.0L	2016-2016					ZR5TPP33	0242145515						
645Ci	V8 4.4L	2005-2005							FGR7DQP+	0242236562				

 Marca / Modelo	 Motor	 Años	 Doble Iridio		 Iridio		 Doble Platino		 Platino		 Super 4		 Níquel	
			Fórmula	Nº. de Parte	Fórmula	Nº. de Parte	Fórmula	Nº. de Parte	Fórmula	Nº. de Parte	Fórmula	Nº. de Parte	Fórmula	Nº. de Parte
650i	V8 4.4L	2013-2018					ZR5TPP330	0242145541						
		2012-2012					ZR5TPP33	0242145515						
650i Gran Coupe	V8 4.4L	2015-2019					ZR5TPP330	0242145541						
740i	L6 3.0L	2016-2019					ZR5SPP3320	0242145555						
		2013-2015					ZR5TPP33	0242145515						
		2010-2012											ZGR6STE2	0242140507
	V8 4.4L	1999-2001							FGR7DQP+	0242236562				
		1998-2001	FR7DII33X	0242236596			FR7DPP33X	0242236631			FR78X	0242232502	FR7LDC+	0242235668
740iL	V8 4.4L	2000-2001	FR7DII33X	0242236596			FR7DPP33X	0242236631	FGR7DQP+	0242236562	FR78X	0242232502	FR7LDC+	0242235668
745i	V8 4.4L	2002-2005						FGR7DQP+	0242236562					
745Li	V8 4.4L	2003-2005						FGR7DQP+	0242236562					
750i	V8 4.4L	2012-2012					ZR5TPP33	0242145515						
	V8 4.8L	2006-2009					FR7KPP332	0242235776						
750iL	V12 5.4L	1995-2001							FGR7DQP+	0242236562				
	V8 4.8L	2006-2008					FR7KPP332	0242235776						
760Li	V12 6.0L	2014-2015					ZR5TPP33	0242145515						
		2003-2008							FGR7DQP+	0242236562				
850Ci	V12 5.4L	1995-1997						FGR7DQP+	0242236562					
Active Hybrid 3	L6 3.0L	2014-2015					ZR5TPP33	0242145515						
Active Hybrid 5	L6 3.0L	2014-2015					ZR5TPP33	0242145515						
M2	L6 3.0L	2017-2019					ZR5TPP330	0242145541						
M235i	L6 3.0L	2015-2016					ZR5TPP33	0242145515						
M240i	L6 3.0L	2017-2019					ZR5SPP3320	0242145555						
M3	L6 3.0L	2015-2018					ZR5TPP330	0242145541						
		1995-1995	FR7DII33X	0242236596			FR7DPP33X	0242236631	FR7DPP30T	0242236618			FR7LDC+	0242235668
	2001-2006											YR6LDE	0242140504	
	L6 3.2L	1996-1999							FR8DPP30X	0242230557			FGR8KQE	0242229613
		1996-1996										FR7LDC+	0242235668	
M4	L6 3.0L	2015-2019					ZR5TPP330	0242145541						
M5	V8 4.4L	2012-2016					ZR5TPP330	0242145541						



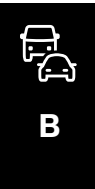

Marca / Modelo	Motor	Años	Doble Iridio		Iridio		Doble Platino		Platino		Super 4		Níquel	
			Fórmula	Nº. de Parte	Fórmula	Nº. de Parte	Fórmula	Nº. de Parte	Fórmula	Nº. de Parte	Fórmula	Nº. de Parte	Fórmula	Nº. de Parte
M5	V8 4.9L	2000-2003							FGR7DQP+	0242236562				
M6	V8 4.4L	2014-2018					ZR5TPP330	0242145541						
M6 Gran Coupe	V8 4.4L	2014-2019					ZR5TPP330	0242145541						
X1	L4 2.0L	2016-2016					ZR5SPP3320	0242145555						
		2012-2012					ZR5TPP330	0242145541						
X3	L4 2.0L	2018-2019					ZR5SPP3320	0242145555						
	L6 2.5L	2007-2008					FR7NPP332	0242236510						
		2004-2006							FGR7DQP+	0242236562				
X3	L6 3.0L	2018-2019					ZR5SPP3320	0242145555						
		2011-2017					ZR5TPP33	0242145515						
		2010-2012							FR7SPP302U	0242236653				
		2007-2010					FR7NPP332	0242236510						
	2004-2006							FGR7DQP+	0242236562					
X4	L4 2.0L	2019-2019					ZR5SPP3320	0242145555						
	L6 3.0L	2017-2018					ZR5TPP330	0242145541						
		2015-2018					ZR5TPP33	0242145515						
X5	L4 2.0L	2016-2018					ZR5TPP330	0242145541						
		2012-2018					ZR5TPP33	0242145515						
		2010-2010							FR7SPP302U	0242236653				
	L6 3.0L	2007-2010					FR7NPP332	0242236510						
		2001-2006							FGR7DQP+	0242236562				
	V8 4.4L	2015-2018					ZR5TPP330	0242145541						
		2011-2013					ZR5TPP33	0242145515						
2000-2006								FGR7DQP+	0242236562					
V8 4.8L	2005-2010					FR7KPP332	0242235776							
	2005-2005							FGR7DQP+	0242236562					
X6	L6 3.0L	2011-2019					ZR5TPP33	0242145515						
		2015-2019					ZR5TPP330	0242145541						
	V8 4.4L	2011-2014					ZR5TPP33	0242145515						
Z3	L4 1.9L	1996-1998	FR7DII33X	0242236596			FR7DPP33X	0242236631	FR7DPP30T	0242236618			FR7LDC+	0242235668
	L6 2.0L	2000-2000									FR78X	0242232502	FR7LDC+	0242235668

Marca / Modelo	Motor	Años	Doble Iridio		Iridio		Doble Platino		Platino		Super 4		Níquel	
			Fórmula	Nº. de Parte	Fórmula	Nº. de Parte	Fórmula	Nº. de Parte	Fórmula	Nº. de Parte	Fórmula	Nº. de Parte	Fórmula	Nº. de Parte

CADILLAC

ATS	L4 2.0L	2013-2019	HR7NII332S	0242236675										
	V6 3.6L	2016-2019	HR6MII33T	0242240711										
Catera	V6 3.0L	1997-2001							FR7DPP30X	0242236616				
CTS	L4 2.0L	2015-2019	HR7NII332S	0242236675										
	V6 3.0L	2010-2013	HR7NII33X	0242236591			HR7MPP33X	0242236629	HR7MPP30X	0242236617				
	V6 3.2L	2003-2003											FGR8KQE0	0242229648
	V6 3.6L	2010-2014	HR7NII33X	0242236591			HR7MPP33X	0242236629	HR7MPP30X	0242236617				
		2005-2010							HR8NPP302	0242229739				
		2004-2009	HR8NII332X	0242230530										
	V8 6.2L	2004-2005							HR7MPP302X	0242235767				
2016-2019		HR7NII33T	0242236674											
DeVille	V8 4.6L	2012-2014	HR8LI33U	0242230523			HR8LPP33U	0242230577	HR8LPP30U	0242230558				
		2000-2004	HR7DII33V	0242236594			HR7DPP33V	0242236625						
		1995-1999	HR8KII33V	0242230535			HR8DPP33V	0242230583	HR8DPP30V	0242230561				
	1994-1994	HR8KII33Y	0242230536			HR8DPP33Y	0242230581	HR8DPP30Y	0242230559					
V8 4.9L	1991-1995	HR8KII33Y	0242230536			HR8DPP33Y	0242230581	HR8DPP30Y	0242230559					
Eldorado	V8 4.6L	1994-1994	HR8KII33Y	0242230536			HR8DPP33Y	0242230581	HR8DPP30Y	0242230559				
Escalade	V8 6.0L	2002-2006	HR8LI33U	0242230523			HR8LPP33U	0242230577	HR8LPP30U	0242230558				
	V8 6.2L	2015-2020	HR8SII33W	0242230615										
		2007-2016	HR8LI33U	0242230523			HR8LPP33U	0242230577	HR8LPP30U	0242230558				
Escalade ESV	V8 6.2L	2015-2020	HR8SII33W	0242230615										
		2009-2015	HR8LI33U	0242230523					HR8LPP30U	0242230558				
Escalade EXT	V8 6.0L	2002-2006	HR8LI33U	0242230523			HR8LPP33U	0242230577	HR8LPP30U	0242230558				
	V8 6.2L	2007-2013	HR8LI33U	0242230523			HR8LPP33U	0242230577	HR8LPP30U	0242230558				
Seville	V8 4.6L	2000-2004	HR7DII33V	0242236594			HR7DPP33V	0242236625						
		1995-1999	HR8KII33V	0242230535			HR8DPP33V	0242230583	HR8DPP30V	0242230561				
		1994-1994	HR8KII33Y	0242230536			HR8DPP33Y	0242230581	HR8DPP30Y	0242230559				
SRX	V6 3.0L	2010-2011	HR7NII33X	0242236591			HR7MPP33X	0242236629	HR7MPP30X	0242236617				
	V6 3.6L	2012-2016	HR7NII33X	0242236591			HR7MPP33X	0242236629	HR7MPP30X	0242236617				
		2005-2006							HR8NPP302	0242229739				

Marca / Modelo	Motor	Años	Doble Iridio		Iridio		Doble Platino		Platino		Super 4		Níquel	
			Fórmula	Nº. de Parte	Fórmula	Nº. de Parte	Fórmula	Nº. de Parte	Fórmula	Nº. de Parte	Fórmula	Nº. de Parte	Fórmula	Nº. de Parte
SRX	V6 3.6L	2004-2006	HR8NII332X	0242230530										
		2004-2004							HR7MPP302X	0242235767				
	V8 4.6L	2004-2006	HR7DII33V	0242236594			HR7DPP33V	0242236625						
STS	V6 3.6L	2010-2010	HR7NII33X	0242236591			HR7MPP33X	0242236629	HR7MPP30X	0242236617				
		2006-2009	HR8NII332X	0242230530					HR8NPP302	0242229739				
	V8 4.6L	2005-2010	HR7DII33V	0242236594			HR7DPP33V	0242236625						
XLR	V8 4.6L	2004-2006	HR7DII33V	0242236594			HR7DPP33V	0242236625						

CHEVROLET

Astra	L4 1.8L	2008-2008											FR7DC+	0242235666
		2006-2008					FR8LPP33X	0242230580	FR8LPP30X	0242230560			FQR8LEU2	0242229699
		2000-2003							FR8DPP30T	0242230572			FLR8LDCU+	0242229654
	L4 2.0L	2004-2008						FR7DPP30X	0242236616	WR78	0242232504			
Astra	L4 2.2L	2001-2003											HLR8STEX	0242229661
		L4 2.4L	2004-2006										FLR8LDCU+	0242229654
Avalanche	V8 5.3L	2007-2013	HR8LI33U	0242230523			HR8LPP33U	0242230577	HR8LPP30U	0242230558				
Avalanche 1500	V8 5.3L	2002-2006	HR8LI33U	0242230523			HR8LPP33U	0242230577	HR8LPP30U	0242230558				
Aveo	L4 1.5L	2018-2020											YR7ME	0242135545
		2012-2018	FR7DII33X	0242236596			FR7DPP33X	0242236631	FR7DPP30X	0242236616			FR7DCX+	0242235667
		2008-2011											FQR8LEU2	0242229699
Blazer	V6 4.3L	1996-2001	HR9KII33Y	0242225659			HR9DPP33Y	0242225677	HR9DPP30Y	0242225670			FR8DCX+	0242229660
		1995-1995	HR9BII33V	0242225665					HR9BPP30V	0242225671				
C10	L6 4.1L	1976-1981	HR9BII33V	0242225665					HR9BPP30X	0242225673				
		1975-1981					HR8DPP33Y	0242230581						
		1975-1975	HR8KII33Y	0242230536					HR8DPP30Y	0242230559				
	L6 4.8L	1975-1979	HR9BII33V	0242225665					HR9BPP30X	0242225673				
	V8 5.7L	1980-1981	HR9BII33V	0242225665					HR9BPP30X	0242225673				
C15	L6 4.1L	1982-1988	HR9BII33V	0242225665					HR9BPP30X	0242225673				
		L6 4.8L	1982-1986						HR7BPP30X	0242236615				
C1500	V6 4.3L	1999-2002	HR9KII33Y	0242225659			HR9DPP33Y	0242225677	HR9DPP30Y	0242225670				
C20	V8 5.7L	1986-1987							HR7BPP30X	0242236615				
C2500	V8 5.7L	1996-1999	HR9KII33Y	0242225659			HR9DPP33Y	0242225677	HR9DPP30Y	0242225670				
		1988-1994	HR9BII33V	0242225665					HR9BPP30V	0242225671				



C



Marca / Modelo	Motor	Años	Doble Iridio		Iridio		Doble Platino		Platino		Super 4		Níquel		
			Fórmula	Nº. de Parte	Fórmula	Nº. de Parte	Fórmula	Nº. de Parte	Fórmula	Nº. de Parte	Fórmula	Nº. de Parte	Fórmula	Nº. de Parte	
C30	L6 4.1L	1980-1980	HR9BII33V	0242225665					HR9BPP30X	0242225673					
	V8 5.7L	1975-1980	HR9BII33V	0242225665					HR9BPP30X	0242225673					
C35	L6 4.8L	1987-1987							HR7BPP30X	0242236615					
	V8 5.7L	1996-2000	HR9KII33Y	0242225659			HR9DPP33Y	0242225677	HR9DPP30Y	0242225670					
Camaro	L4 2.0L	2016-2018	HR7NII332S	0242236675											
	V6 3.6L	2010-2015	HR7NII33X	0242236591			HR7MPP33X	0242236629	HR7MPP30X	0242236617					
	V6 3.8L	1996-1998	HR9KII33Y	0242225659			HR9DPP33Y	0242225677	HR9DPP30Y	0242225670					
	V8 5.7L	1999-2002	HR8LII33U	0242230523				HR8LPP33U	0242230577	HR8LPP30U	0242230558				
		1996-1996						HR8DPP33V	0242230583	HR8DPP30V	0242230561				
		1995-1996	HR8KII33V	0242230535											
	1995-1995						HR9DPP33Y	0242225677	HR9DPP30Y	0242225670					
V8 6.2L	2016-2020	HR8SII33W	0242230615												
		2010-2015	HR8LII33U	0242230523			HR8LPP33U	0242230577	HR8LPP30U	0242230558					
Caprice	V8 5.7L	1980-1981	HR9BII33V	0242225665					HR9BPP30X	0242225673					
Captiva Sport	L4 2.4L	2008-2015			HR8NI332W	0242230508									
	L6 3.0L	2014-2014	HR7NII33X	0242236591			HR7MPP33X	0242236629	HR7MPP30X	0242236617					
		2012-2013											HR8MCV+	0242229785	
		2011-2015	HR7NII33X	0242236591			HR7MPP33X	0242236629	HR7MPP30X	0242236617					
V6 3.6L	2008-2010	HR8NII332X	0242230530					HR8NPP302X	0242230573						
Cavalier	L4 2.2L	1998-2002	HR8DII33X	0242230524			HR8DPP33X	0242230588	HR8DPP30X	0242230569					
		1995-1997	HR8JII33V	0242230555			HR8JPP33V	0242230589	HR8JPP302V	0242230563					
	L4 2.4L	1996-1996	HR8KII33V	0242230535			HR8DPP33V	0242230583	HR8DPP30V	0242230561					
	V6 2.8L	1990-1994	HR9LII33X	0242225661			HR9LPP33X	0242225678	HR9LPP30X	0242225674					
V6 3.1L	1991-1994	HR9LII33X	0242225661				HR9LPP33X	0242225678	HR9LPP30X	0242225674					
	1987-1989	HR9LII33X	0242225661				HR9LPP33X	0242225678	HR9LPP30X	0242225674					
Celebrity	V6 2.8L	1982-1986							HR7BPP30X	0242236615					
	L4 1.4L	1994-2002							WR7DPP30W	0242236647			WR7DC+	0242235663	
Chevy	L4 1.6L	1996-2012							WR7DPP30W	0242236647			WR7DC+	0242235663	
	Chevy Monza	L4 1.6L	2003-2003						WR7DPP30W	0242236647			WR7DC+	0242235663	
Chevy Pickup	L4 1.6L	2000-2003									WR78	0242232504			
		1999-2003							WR7DPP30W	0242236647			WR7DC+	0242235663	
Cheyenne	V8 5.3L	2014-2019	HR8SII33W	0242230615											
		2007-2013	HR8LII33U	0242230523			HR8LPP33U	0242230577	HR8LPP30U	0242230558					

Marca / Modelo	Motor	Años	Doble Iridio		Iridio		Doble Platino		Platino		Super 4		Níquel		
			Fórmula	Nº. de Parte	Fórmula	Nº. de Parte	Fórmula	Nº. de Parte	Fórmula	Nº. de Parte	Fórmula	Nº. de Parte	Fórmula	Nº. de Parte	
Cheyenne	V8 6.2L	2014-2019	HR8SII33W	0242230615											
Citation	V6 2.8L	1982-1986							HR7BPP30X	0242236615					
Colorado	L4 2.5L	2016-2020	HR8MII33X	0242230611											
	L4 2.9L	2011-2012	HR8MII33X	0242230611			HR8MPP33X	0242230582	HR8MPP30X	0242230564			HR9DCY+	0242225623	
	L5 3.5L	2004-2006	HR8MII33X	0242230611			HR8MPP33X	0242230582	HR8MPP30X	0242230564					
	L5 3.7L	2007-2012	HR8MII33X	0242230611			HR8MPP33X	0242230582	HR8MPP30X	0242230564			HR9DCY+	0242225623	
	V6 3.6L	2013-2016	HR7NII33X	0242236591			HR7MPP33X	0242236629	HR7MPP30X	0242236617					
Corsa	L4 1.4L	2002-2002													
	L4 1.8L	2006-2008												FLR8LDCU+	0242229654
		2003-2008												WR7DC+	0242235663
		2003-2005												WR7KC+	F000KE0P43
Corvette	V8 5.7L	1997-2003	HR8LII33U	0242230523			HR8LPP33U	0242230577	HR8LPP30U	0242230558					
		1995-2004												HR8DCX+	0242229775
		1993-1996						HR9DPP33Y	0242225677	HR9DPP30Y	0242225670				
		1992-1996	HR8KII33V	0242230535											
		1992-1994	HR8KII33Y	0242230536			HR8DPP33Y	0242230581	HR8DPP30Y	0242230559					
		1992-1992					HR8DPP33V	0242230583	HR8DPP30V	0242230561					
		1991-1992	FR7DII33X	0242236596			FR7DPP33X	0242236631	FR7DPP30T	0242236618				FR8DC+	0242229659
	V8 6.0L	2005-2007	HR8LII33U	0242230523			HR8LPP33U	0242230577	HR8LPP30U	0242230558					
	V8 6.2L	2014-2019	HR8SII33W	0242230615											
		2008-2013	HR8LII33U	0242230523			HR8LPP33U	0242230577	HR8LPP30U	0242230558					
V8 6.2L Supercargado	2015-2018	HR7NII33T	0242236674												
Cruze	L4 1.4L	2014-2015	FR7KII332S	0242236668											
	L4 1.8L	2014-2016	FR8LII33X	0242230531			FR7LPP33X	0242236626					FR7LCX+	0242236542	
		2010-2013	FR7DII33X	0242236596			FR7DPP33X	0242236631	FR7DPP30X	0242236616			FR7DC+	0242235666	
Epica	L6 2.5L	2009-2009					FR6KPP33X+	0242240649							
Equinox	L4 2.4L	2016-2017			HR8NI332W	0242230508									
	V6 3.4L	2005-2008	HR9KII33Y	0242225659			HR9DPP33Y	0242225677	HR9DPP30Y	0242225670			FR8DCX+	0242229660	
Express 1500	V6 4.3L	1998-2008	HR9KII33Y	0242225659			HR9DPP33Y	0242225677	HR9DPP30Y	0242225670					
	V8 5.3L	2003-2008	HR8LII33U	0242230523			HR8LPP33U	0242230577	HR8LPP30U	0242230558					
	V8 5.7L	1998-2002	HR9KII33Y	0242225659			HR9DPP33Y	0242225677	HR9DPP30Y	0242225670					
Express 2500	V8 5.7L	1999-1999	HR9KII33Y	0242225659			HR9DPP33Y	0242225677	HR9DPP30Y	0242225670					



C

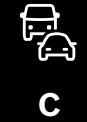

Marca / Modelo	Motor	Años	Doble Iridio		Iridio		Doble Platino		Platino		Super 4		Níquel	
			Fórmula	Nº. de Parte	Fórmula	Nº. de Parte	Fórmula	Nº. de Parte	Fórmula	Nº. de Parte	Fórmula	Nº. de Parte	Fórmula	Nº. de Parte
Express 3500	V8 4.8L	2004-2004	HR8LII33U	0242230523			HR8LPP33U	0242230577	HR8LPP30U	0242230558				
	V8 5.3L	2003-2008	HR8LII33U	0242230523			HR8LPP33U	0242230577	HR8LPP30U	0242230558				
	V8 5.7L	1998-2002	HR9KII33Y	0242225659			HR9DPP33Y	0242225677	HR9DPP30Y	0242225670			HR9DCY+	0242225623
	V8 6.0L	2004-2004	HR8LII33U	0242230523			HR8LPP33U	0242230577	HR8LPP30U	0242230558				
Express Cargo	V6 4.3L	2018-2018	HR8SII33W	0242230615										
		2009-2009	HR9KII33Y	0242225659			HR9DPP33Y	0242225677	HR9DPP30Y	0242225670				
	V8 6.0L	2010-2016	HR8LII33U	0242230523			HR8LPP33U	0242230577	HR8LPP30U	0242230558				
Express Pasajeros	V8 5.3L	2010-2015	HR8LII33U	0242230523			HR8LPP33U	0242230577	HR8LPP30U	0242230558				
	V8 6.0L	2010-2018	HR8LII33U	0242230523			HR8LPP33U	0242230577	HR8LPP30U	0242230558				
G20	V6 4.3L	1995-1995	HR9BII33V	0242225665					HR9BPP30V	0242225671				
G30	V6 4.3L	2001-2002	HR9KII33Y	0242225659					HR9DPP30Y	0242225670				
Impala	V6 3.8L	2000-2003	HR9KII33Y	0242225659					HR9DPP30Y	0242225670				
	V8 5.7L	1975-1975	HR9BII33V	0242225665					HR9BPP30X	0242225673				
Lumina Van	V6 3.8L	1995-1996	HR8KII33Y	0242230536			HR8DPP33Y	0242230581	HR8DPP30Y	0242230559				
LUV	L4 2.2L	2005-2005											WR9DC+	0242225599
		1999-2005							WR8DPP30W	0242230599				
	L4 2.3L	1997-1997							HR9DPP30Y	0242225670			WR8DCX+	0242229687
Malibu	L4 2.0L	2013-2019	HR7NII332S	0242236675										
	L4 2.2L	2004-2005	HR8MII33X	0242230611			HR8MPP33X	0242230582	HR8MPP30X	0242230564				
	L4 2.4L	2009-2012	HR8MII33X	0242230611			HR8MPP33X	0242230582	HR8MPP30X	0242230564				
		1997-1999	HR8KII33V	0242230535			HR8DPP33V	0242230583	HR8DPP30V	0242230561				
	L4 2.5L	2013-2015	HR8MII33X	0242230611										
	L6 4.1L	1979-1981	HR9BII33V	0242225665					HR9BPP30X	0242225673				
	V6 3.1L	2002-2003	HR9KII33Y	0242225659			HR9DPP33Y	0242225677	HR9DPP30Y	0242225670				
		1997-2001	HR8KII33Y	0242230536			HR8DPP33Y	0242230581	HR8DPP30Y	0242230559				
	V6 3.5L	2007-2008	HR9LII33X	0242225661			HR9LPP33X	0242225678	HR9LPP30X	0242225674				
	V6 3.5L	2006-2006	HR9KII33Y	0242225659			HR9DPP33Y	0242225677	HR9DPP30Y	0242225670				
	V6 3.6L	2011-2012	HR7NII33X	0242236591			HR7MPP33X	0242236629	HR7MPP30X	0242236617				
		2009-2010	HR8NII332X	0242230530					HR8NPP302	0242229739				
	V8 5.7L	1980-1981							HR9BPP30X	0242225673				
1975-1981		HR9BII33V	0242225665											
1975-1979								HR9BPP30V	0242225671					
Matiz	L4 1.0L	2011-2015						WR8DPP30W	0242230599			WR9DC+	0242225599	

Marca / Modelo	Motor	Años	Doble Iridio		Iridio		Doble Platino		Platino		Super 4		Níquel	
			Fórmula	Nº. de Parte	Fórmula	Nº. de Parte	Fórmula	Nº. de Parte	Fórmula	Nº. de Parte	Fórmula	Nº. de Parte	Fórmula	Nº. de Parte
Meriva	L4 1.8L	2004-2008							WR8DPP30W	0242230599	WR78	0242232504	WR7KC+	F000KE0P43
Nova	L6 4.1L	1975-1978	HR9BII33V	0242225665					HR9BPP30X	0242225673				
	V8 5.7L	1977-1978	HR9BII33V	0242225665					HR9BPP30X	0242225673				
Optra	L4 2.0L	2006-2010							FR8DPP30T	0242230572			FLR8LDCU+	0242229654
P30	V8 5.7L	2000-2005	HR8KII33V	0242230535			HR8DPP33V	0242230583	HR8DPP30V	0242230561				
		1997-1998	HR9KII33Y	0242225659			HR9DPP33Y	0242225677	HR9DPP30Y	0242225670				
		1991-1996	HR9BII33V	0242225665					HR9BPP30V	0242225671				
		1991-1994												HR9BC+
S10	L4 2.2L	1995-2003	HR8DII33X	0242230524			HR8DPP33X	0242230588	HR8DPP30X	0242230569				
		1995-1995	HR8JII33V	0242230555			HR8JPP33V	0242230589	HR8JPP302V	0242230563				
	V6 3.1L	1991-1993											HR9BC+	0242225622
S10 Blazer	V6 3.1L	1991-1994							HR7BPP30X	0242236615			HR9BC+	0242225622
Silverado	V8 5.7L	1995-1999	HR8KII33Y	0242230536			HR8DPP33Y	0242230581	HR8DPP30Y	0242230559			HR9DCY+	0242225623
Silverado 1500	V6 4.3L	2017-2020	HR8SII33W	0242230615										
		2002-2009	HR9KII33Y	0242225659			HR9DPP33Y	0242225677	HR9DPP30Y	0242225670				
	V8 5.3L	2007-2008	HR8LII33U	0242230523			HR8LPP33U	0242230577	HR8LPP30U	0242230558				
Silverado 2500	V6 4.3L	2017-2017	HR8SII33W	0242230615										
	V8 4.8L	2007-2009	HR8LII33U	0242230523			HR8LPP33U	0242230577	HR8LPP30U	0242230558				
	V8 5.3L	2017-2018	HR8SII33W	0242230615										
	V8 5.3L	2001-2016	HR8LII33U	0242230523			HR8LPP33U	0242230577	HR8LPP30U	0242230558				
Silverado 3500	V8 6.0L	2008-2017	HR8LII33U	0242230523			HR8LPP33U	0242230577	HR8LPP30U	0242230558				
	V8 8.1L	2001-2003	HR9LII33X	0242225661			HR9LPP33X	0242225678	HR9LPP30X	0242225674				
Sonic	L4 1.4L	2014-2016	FR6KII332S	0242240707										
Sonora	V8 5.7L	2000-2002	HR8KII33Y	0242230536			HR8DPP33Y	0242230581	HR8DPP30Y	0242230559			HR8DC+	0242229655
Spark	L4 1.2L	2014-2015											YR7DC+	0242135515
		2011-2013									YR78X	0242132501		
Suburban	V8 5.3L	2014-2020	HR8SII33W	0242230615										
	V8 5.7L	1990-1994	HR9BII33V	0242225665					HR9BPP30V	0242225671				
	V8 6.0L	2017-2019	HR8LII33U	0242230523			HR8LPP33U	0242230577	HR8LPP30U	0242230558				
Suburban 1500	V8 5.3L	2003-2013	HR8LII33U	0242230523			HR8LPP33U	0242230577	HR8LPP30U	0242230558				
		1996-1999	HR9KII33Y	0242225659			HR9DPP33Y	0242225677	HR9DPP30Y	0242225670				
	V8 5.7L	1995-2002					HR8DPP33Y	0242230581					HR8DCX+	0242229775
		2010-2013	HR8LII33U	0242230523			HR8LPP33U	0242230577	HR8LPP30U	0242230558				



C

Marca / Modelo	Motor	Años	Doble Iridio		Iridio		Doble Platino		Platino		Super 4		Níquel		
			Fórmula	Nº. de Parte	Fórmula	Nº. de Parte	Fórmula	Nº. de Parte	Fórmula	Nº. de Parte	Fórmula	Nº. de Parte	Fórmula	Nº. de Parte	
300	V6 2.7L	2010-2010	HR8SII330V	0242230542					HR8SPP300V	0242230575					
	V6 3.5L	2006-2008					FR8VPP332V	0242230591							
	V6 3.6L	2012-2019	YR7SII3320U	0242135574	YR7SII302U	0242135555									
	V8 5.7L	2009-2019	FR8SII33X	0242230571											
		2009-2013					FR8SPP33X	0242230604	FR8SPP30X	0242230576			FR8SEX	0242230624	
	2005-2008	HR9SII330X	0242225664			HR9SPP330X	0242225680	HR9SPP300X	0242225672			HR9SEX	0242225668		
300M	V8 6.1L	2006-2008	HR8SII330V	0242230542					HR8SPP300V	0242230575					
Aspen	V8 5.7L	2009-2009	FR8SII33X	0242230571			FR8SPP33X	0242230604	FR8SPP30X	0242230576			FR8SEX	0242230624	
		2007-2008	HR9SII330X	0242225664			HR9SPP330X	0242225680	HR9SPP300X	0242225672			HR9SEX	0242225668	
Breeze	L4 2.0L	1996-1996							WR7DPP30W	0242236647			WR7DCX+	0242235707	
Chrysler R/T	L4 2.4L	1997-1997	FR8KII33X	0242230528			FR8DPP33X	0242230579	FR8DPP30X	0242230557			FR7DCX+	0242235667	
Cirrus	L4 2.4L	1998-2010	FR8KII33X	0242230528			FR8DPP33X	0242230579	FR8DPP30X	0242230557			FR7DCX+	0242235667	
	V6 2.5L	1996-2000	FR8DII33X	0242230534			FR8DPP33X	0242230579	FR8DPP30X	0242230557					
	V6 2.7L	2004-2006	FR8DII33X	0242230534			FR8DPP33X	0242230579	FR8DPP30X	0242230557					
	V6 3.5L	2007-2010					FR8VPP332V	0242230591							
Concorde	V6 3.2L	2001-2001	FR8VII33U	0242230532			FR8VPP332V	0242230591							
	V6 3.5L	2002-2002					FR8VPP332V	0242230591							
		1993-1997	FR8VII33U	0242230532			FR8VPP33U	0242230585	FR8VPP30U	0242230565					
Cordoba	V8 5.9L	1980-1980					WR8LPP33X	0242230587	WR8DPP30W	0242230599			WR8DCX+	0242229687	
Crossfire	V6 3.2L	2004-2007	FR8KII33X	0242230528			FR8DPP33+	0242230500	FR8DPP30X	0242230557					
Grand Voyager	V6 3.8L	1996-2000							WR8LPP30V	0242230574					
		1994-2000					WR8LPP33X	0242230587							
		1994-1995							WR8DPP30W	0242230599			WR8DCX+	0242229687	
Imperial	V6 3.3L	1991-1991					WR8LPP33X	0242230587							
Intrepid	V6 3.5L	1994-1997	FR8VII33U	0242230532			FR8VPP33U	0242230585	FR8VPP30U	0242230565					
LeBaron	L4 2.2L	1983-1987						WR8LPP33X	0242230587	WR8DPP30W	0242230599			WR8DCX+	0242229687
		1986-1987								WR8DPP30W	0242230599				
		1984-1987						WR8LPP33X	0242230587						
	L4 2.5L	1993-1995												WR8DCX+	0242229687
		1991-1995						WR8LPP33X	0242230587	WR8DPP30W	0242230599				
	V8 5.9L	1979-1982					WR8LPP33X	0242230587	WR8DPP30W	0242230599					
LHS	V6 3.5L	1996-1997	FR8VII33U	0242230532			FR8VPP33U	0242230585	FR8VPP30U	0242230565					



C



Marca / Modelo	Motor	Años	Doble Iridio		Iridio		Doble Platino		Platino		Super 4		Níquel	
			Fórmula	Nº. de Parte	Fórmula	Nº. de Parte	Fórmula	Nº. de Parte	Fórmula	Nº. de Parte	Fórmula	Nº. de Parte	Fórmula	Nº. de Parte
Neon	L4 2.0L	1995-1997							FR8DPP30T	0242230572			FR8DC+	0242229659
		1995-1997							FR7DPP30T	0242236618	FR78	0242232501	FR7DC+	0242235666
New Yorker	L4 2.2L	1985-1988					WR8LPP33X	0242230587	WR8DPP30W	0242230599			WR8DCX+	0242229687
	L4 2.2L Turbo	1985-1986							WR8DPP30W	0242230599				
Pacifica	V6 3.5L	1995-1995	FR8VII33U	0242230532				FR8VPP33U	0242230585	FR8VPP30U	0242230565			
	V6 3.5L	2004-2006						FR8VPP332V	0242230591					
	V6 3.6L	2017-2019	YR7SII3320U	0242135574										
	V6 3.8L	2007-2007	HR8TII3302V	0242230526				HR8TTP3302V	0242230586	HR8TTP3002V	0242230566			
Phantom	L4 2.2L	1988-1989											WR9DC+	0242225599
	L4 2.4L	2001-2010	HR9SII330X	0242225664				HR9SPP330X	0242225680	HR9SPP300X	0242225672			HR9SE0X
PT Cruiser	L4 2.4L	2006-2007											HR9SE0X	0242225668
	L4 2.4L Turbo	2006-2007											HR9SE0X	0242225668
Shadow	L4 2.2L	1989-1990					WR8LPP33X	0242230587	WR8DPP30W	0242230599			WR8DCX+	0242229687
	L4 2.5L	1989-1994					WR8LPP33X	0242230587	WR8DPP30W	0242230599			WR8DCX+	0242229687
Spirit	L4 2.5L	1990-1995					WR8LPP33X	0242230587	WR8DPP30W	0242230599			WR8DCX+	0242229687
Stratus	L4 2.0L	1995-1997							WR7DPP30W	0242236647	FR78	0242232501	WR7DCX+	0242235707
	L4 2.4L	1995-1997	FR8KII33X	0242230528				FR8DPP33X	0242230579	FR8DPP30X	0242230557			FR8DCX+
Town & Country	V6 3.3L	2010-2010	HR8TII3302V	0242230526				HR8TTP3302V	0242230586	HR8TTP3002V	0242230566			
	V6 3.6L	2011-2016	YR7SII3320U	0242135574	YR7SII302U	0242135555								
	V6 3.8L	2001-2010	HR8TII3302V	0242230526				HR8TTP3302V	0242230586	HR8TTP3002V	0242230566			
		1996-2000								WR8LPP30V	0242230574			
		1994-2000						WR8LPP33X	0242230587					
V6 4.0L	1994-1995							WR8DPP30W	0242230599			WR8DCX+	0242229687	
Voyager	V6 3.3L	2001-2003	HR8TII3302V	0242230526				HR8TTP3302V	0242230586	HR8TTP3002V	0242230566			
		1994-2000						WR8LPP33X	0242230587	WR8LPP30V	0242230574			

DODGE









Atos	L4 1.0L	2001-2004											FR8DCX+	0242229660	
		2001-2004	FR8DII33X	0242230534				FR8DPP33X	0242230579	FR8DPP30X	0242230557	FR78X	0242232502	FR7DCX+	0242235667
Attitude	L4 1.1L	2005-2012	FR8DII33X	0242230534				FR8DPP33X	0242230579	FR8DPP30X	0242230557	FR78X	0242232502	FR7DCX+	0242235667
	L3 1.2L	2017-2017						FR7SI30	0242235769						
	L4 1.4L	2006-2014	FR8KII33X	0242230528				FR8DPP33X	0242230579	FR8DPP30X	0242230557			FR7DCX+	0242235667

Marca / Modelo	Motor	Años	Doble Iridio		Iridio		Doble Platino		Platino		Super 4		Níquel		
			Fórmula	Nº. de Parte	Fórmula	Nº. de Parte	Fórmula	Nº. de Parte	Fórmula	Nº. de Parte	Fórmula	Nº. de Parte	Fórmula	Nº. de Parte	
Attitude	L4 1.6L	2012-2014	YR8SII33U	0242129524											
		2012-2013												FR7DCX+	0242235667
		2006-2013													
		2006-2011	FR8DII33X	0242230534			FR8DPP33X	0242230579	FR8DPP30X	0242230557				FR8DCX+	0242229660
Avenger	L4 2.0L	2008-2010	FR8LI33X	0242230531			FR8LPP33X	0242230580	FR8LPP30X	0242230560			FR8LCX	0242229576	
	L4 2.4L	2008-2014	FR8LI33X	0242230531			FR8LPP33X	0242230580	FR8LPP30X	0242230560			FR8LCX	0242229576	
	V6 3.5L	2008-2009					FR8VPP332V	0242230591							
B2500	V8 5.2L	1997-1998							FR8HPP30X	0242230567					
		1995-1998	FR8DII33X	0242230534			FR8DPP33X	0242230579							
		1995-1995					WR8LPP33X	0242230587	FR8DPP30X	0242230557			FR8DCX+	0242229660	
		1995-1995							WR8DPP30W	0242230599			WR8DCX+	0242229687	
B3500	V8 5.2L	1997-1998							FR8HPP30X	0242230567					
		1995-1998									FR78X	0242232502			
		1995-1996	FR8DII33X	0242230534			FR8DPP33X	0242230579	FR8DPP30X	0242230557			FR8DCX+	0242229660	
		1995-1996					WR8LPP33X	0242230587	WR8DPP30W	0242230599			WR8DCX+	0242229687	
Caliber	L4 2.4L	2007-2012	FR8LI33X	0242230531			FR8LPP33X	0242230580	FR8LPP30X	0242230560			FR8LCX	0242229576	
Challenger	V6 3.6L	2013-2019	YR7SII3320U	0242135574	YR7SII302U	0242135555									
	V8 5.7L	2009-2014	FR8SII33X	0242230571			FR8SPP33X	0242230604	FR8SPP30X	0242230576					
		2009-2013											FR8SEX	0242230624	
	V8 6.1L	2008-2009	HR8SII330V	0242230542					HR8SPP300V	0242230575					
V8 6.2L	2015-2019			FR7SI332	0242236655										
Charger	V6 3.5L	2006-2010					FR8VPP332V	0242230591							
	V8 5.7L	2009-2019	FR8SII33X	0242230571											
		2009-2012					FR8SPP33X	0242230604	FR8SPP30X	0242230576			FR8SEX	0242230624	
		2006-2008	HR9SII330X	0242225664			HR9SPP330X	0242225680	HR9SPP300X	0242225672			HR9SE0X	0242225668	
	V8 6.1L	2007-2010	HR8SII330V	0242230542					HR8SPP300V	0242230575					
V8 6.2L	2015-2019			FR7SI332	0242236655										
Coronet	L6 3.7L	1968-1970											WR9DC+	0242225599	
D100	L6 3.7L	1976-1977											HR9BC+	0242225622	
D100 Panel	L6 3.7L	1976-1976											HR9BC+	0242225622	
D150	L6 3.7L	1984-1990	HR9BII33V	0242225665											
		1983-1990							HR9BPP30X	0242225673			HR9BC+	0242225622	
		1981-1982							HR9SPP300X	0242225672					





Marca / Modelo	Motor	Años	Doble Iridio		Iridio		Doble Platino		Platino		Super 4		Níquel		
			Fórmula	Nº. de Parte	Fórmula	Nº. de Parte	Fórmula	Nº. de Parte	Fórmula	Nº. de Parte	Fórmula	Nº. de Parte	Fórmula	Nº. de Parte	
D150	V6 3.9L	1991-1993					WR8LPP33X	0242230587	WR8DPP30W	0242230599			WR8DCX+	0242229687	
	V8 5.9L	1982-1988					WR8LPP33X	0242230587	WR8DPP30W	0242230599			WR8DCX+	0242229687	
D250	V8 5.9L	1986-1992					WR8LPP33X	0242230587	WR8DPP30W	0242230599			WR8DCX+	0242229687	
D300	L6 3.7L	1976-1977											HR9BC+	0242225622	
	V8 5.9L	1980-1980					WR8LPP33X	0242230587	WR8DPP30W	0242230599			WR8DCX+	0242229687	
D350	V8 5.9L	1981-1992					WR8LPP33X	0242230587	WR8DPP30W	0242230599			WR8DCX+	0242229687	
Dakota	L4 2.5L	1996-1996					WR8LPP33X	0242230587	WR8DPP30W	0242230599			WR8DCX+	0242229687	
	V6 3.7L	2005-2012	FR7LII33X	0242236592					FR8LPP302X	0242230570	FR78X	0242232502	FR7LCX+	0242236542	
Dart	L4 2.4L	2014-2016	FR8SII332X	0242230618											
Durango	V6 3.6L	2014-2015	YR7SII3320U	0242135574	YR7SII302U	0242135555									
	V8 4.7L	2001-2007	FR8KII332X	0242230556					FR8LPP302X	0242230570	FR78X	0242232502	FR8LCX	0242229576	
	V8 5.2L	1998-2000							FR8HPP30X	0242230567					
		2009-2019	FR8SII33X	0242230571											
		2009-2017					FR8SPP33X	0242230604	FR8SPP30X	0242230576					
	2009-2013												FR8SEX	0242230624	
V8 5.9L	2004-2008	HR9SII330X	0242225664			HR9SPP330X	0242225680	HR9SPP300X	0242225672			HR9SE0X	0242225668		
Grand Caravan	V6 3.6L	2017-2019	YR7SII3320U	0242135574	YR7SII302U	0242135555									
H100	L4 2.4L	2003-2005											WR7DC+	0242235663	
H100 Van	L4 2.4L	2012-2013	FR8MII33X	0242230533			FR8MPP33X	0242230584	FR8MPP30X	0242230562					
i10	L4 1.1L	2012-2014	FR8DII33X	0242230534			FR8DPP33X	0242230579	FR8DPP30X	0242230557	FR78X	0242232502	FR8DCX+	0242229660	
Intrepid	V6 3.2L	1998-2000	FR8VII33U	0242230532			FR8VPP332V	0242230591	FR8VPP30U	0242230565					
	V6 3.5L	2000-2001	FR8VII33U	0242230532			FR8VPP332V	0242230591							
Journey	L4 2.4L	2009-2020	FR8LII33X	0242230531					FR8LPP30X	0242230560					
		2009-2019				FR8LPP33X	0242230580					FR8LCX	0242229576		
	V6 3.5L	2009-2010					FR8VPP332V	0242230591							
Neon	V6 3.6L	2011-2019	YR7SII3320U	0242135574	YR7SII302U	0242135555									
	L4 1.4L	2017-2017											YR7DC+	0242135515	
		2000-2005				FR6KI332S	0242240653								
L4 2.0L	1998-2005	FR7DII33X	0242236596			FR7DPP33X	0242236631	FR7DPP30T	0242236618	FR78X	0242232502	FR7DC+	0242235666		
L4 2.4L	2004-2005	HR9SII330X	0242225664			HR9SPP330X	0242225680	HR9SPP300X	0242225672			HR9SE0X	0242225668		
Nitro	V6 3.7L	2007-2011	FR7LII33X	0242236592					FR8LPP302X	0242230570	FR78X	0242232502	FR7LCX+	0242236542	
	V6 4.0L	2007-2010					FR8VPP332V	0242230591							

 Marca / Modelo	 Motor	 Años	 Doble Iridio		 Iridio		 Doble Platino		 Platino		 Super 4		 Níquel	
			Fórmula	Nº. de Parte	Fórmula	Nº. de Parte	Fórmula	Nº. de Parte	Fórmula	Nº. de Parte	Fórmula	Nº. de Parte	Fórmula	Nº. de Parte
Ram 1500	V10 8.3L	2005-2006	FR8VII33U	0242230532			FR8VPP33U	0242230585	FR8VPP30U	0242230565				
	V6 3.7L	2003-2010	FR7LII33X	0242236592					FR8LPP302X	0242230570			FR7LCX+	0242236542
		2003-2008									FR78X	0242232502		
	V6 3.9L	1998-2002							FR8HPP30X	0242230567				
		1994-1999	FR8DII33X	0242230534			FR8DPP33X	0242230579	FR8DPP30X	0242230557			FR8DCX+	0242229660
	V8 4.7L	2008-2009			FR8TI332	0242229764							FR8TE2	0242229765
		2003-2009	FR8KII332X	0242230556					FR8LPP302X	0242230570				
	V8 5.2L	2003-2008									FR78X	0242232502	FR8LCX	0242229576
		1998-2000							FR8HPP30X	0242230567				
	V8 5.7L	1995-2000	FR8DII33X	0242230534										
1995-1999						FR8DPP33X	0242230579	FR8DPP30X	0242230557			FR8DCX+	0242229660	
V8 5.9L	2006-2008	HR9SII330X	0242225664					HR9SPP300X	0242225672	HR9SPP300X	0242225672		HR9SE0X	0242225668
	1999-2001							FR8HPP30X	0242230567					
	1995-2001	FR8DII33X	0242230534											
V8 5.9L	1995-1999					FR8DPP33X	0242230579	FR8DPP30X	0242230557			FR8DCX+	0242229660	
	1999-2003							FR8HPP30X	0242230567					
	1999-2002							FR8HPP30X	0242230567					
Ram 2500	V8 4.7L	2008-2009											FR7LCX+	0242236542
		2002-2009	FR8KII332X	0242230556					FR8LPP302X	0242230570				
	2002-2008											FR8LCX	0242229576	
	V8 5.2L	2000-2001						FR8HPP30X	0242230567					
	V8 5.7L	2009-2009	FR8SII33X	0242230571			FR8SPP33X	0242230604	FR8SPP30X	0242230576			FR8SEX	0242230624
		2003-2008	HR9SII330X	0242225664			HR9SPP330X	0242225680	HR9SPP300X	0242225672			HR9SE0X	0242225668
	V8 5.9L	1998-2002							FR8HPP30X	0242230567				
1997-1999		FR8DII33X	0242230534			FR8DPP33X	0242230579	FR8DPP30X	0242230557			FR8DCX+	0242229660	
1995-1996					WR8LPP33X	0242230587	WR8DPP30W	0242230599			WR8DCX+	0242229687		
Ram 2500 Van	V8 5.2L	1999-2002						FR8HPP30X	0242230567					
Ram 3500	V8 5.9L	1998-2002						FR8HPP30X	0242230567					
		1994-1999	FR8DII33X	0242230534			FR8DPP33X	0242230579	FR8DPP30X	0242230557			FR8DCX+	0242229660
Ram 3500 Van	V8 5.2L	1999-2002						FR8HPP30X	0242230567					
	V8 5.9L	1999-2002						FR8HPP30X	0242230567					
		1997-2002	FR8DII33X	0242230534										





Marca / Modelo	Motor	Años	Doble Iridio		Iridio		Doble Platino		Platino		Super 4		Níquel		
			Fórmula	Nº. de Parte	Fórmula	Nº. de Parte	Fórmula	Nº. de Parte	Fórmula	Nº. de Parte	Fórmula	Nº. de Parte	Fórmula	Nº. de Parte	
Ramcharger	V8 5.2L	2000-2001							FR8HPP30X	0242230567			FR7LCX+	0242236542	
	V8 5.9L	1995-2001	FR8DII33X	0242230534				FR8DPP33X	0242230579	FR8DPP30X	0242230557			FR8DC+	0242229659
		1980-1993						WR8LPP33X	0242230587	WR8DPP30W	0242230599			WR8DCX+	0242229687
Stratus	L4 2.0L	2001-2006	HR9SII330X	0242225664					HR9SPP300X	0242225672			FR8DCX+	0242229660	
		1998-2000	FR7DII33X	0242236596			FR7DPP33X	0242236631	FR7DPP30T	0242236618	FR78	0242232501	FR7DC+	0242235666	
	L4 2.4L	2004-2005	HR8SII330V	0242230542					HR8SPP300V	0242230575					
		2001-2006	HR9SII330X	0242225664					HR9SPP330X	0242225680	HR9SPP300X	0242225672		HR9SE0X	0242225668
		1998-2004							FR8DPP33X	0242230579					
	L4 2.4L Turbo	1998-2000	FR8KII33X	0242230528					FR8DPP30X	0242230557				FR8DCX+	0242229660
		2006-2006	HR9SII330X	0242225664					HR9SPP300X	0242225672					
	2001-2006					HR9SPP330X	0242225680								
Van 1000	L4 2.4L	2008-2009							WR7DPP30W	0242236647	WR78X	0242232505	WR7DCX+	0242235707	
Verna	L4 1.5L	2004-2006	FR8DII33X	0242230534				FR8DPP33X	0242230579	FR8DPP30X	0242230557			FR8DCX+	0242229660
	L4 1.6L	2004-2006	FR8DII33X	0242230534				FR8DPP33X	0242230579	FR8DPP30X	0242230557	FR78X	0242232502	FR8DCX+	0242229660
Viper	V10 8.0L	1992-2000	FR8VII33U	0242230532				FR8VPP33U	0242230585	FR8VPP30U	0242230565				
	V10 8.3L	2003-2006	FR8VII33U	0242230532				FR8VPP33U	0242230585	FR8VPP30U	0242230565				
	V10 8.4L	2008-2015	HR8SII330V	0242230542						HR8SPP300V	0242230575				
W150	L6 3.7L	1985-1986	HR9BII33V	0242225665						HR9BPP30X	0242225673				
	V8 5.9L	1985-1986						WR8LPP33X	0242230587	WR8DPP30W	0242230599			WR8DCX+	0242229687

FAW

F1	L3 1.0L	2008-2009												FR7DCX+	0242235667
F4	L4 1.4L	2008-2008												FR7DCX+	0242235667

FERRARI

F355	V8 3.5L	1999-1999												UR6DE	0242040502
F355 Spider	V8 3.5L	2000-2001												UR6DE	0242040502

FIAT

500	L4 1.4L	2014-2019	YR5DII33S	0242145571											
		2014-2017					FR8MPP33X	0242230584	FR8MPP30X	0242230562					
		2009-2013												YR7DC+	0242135515
		2009-2011									YR78X	0242132501			









Marca / Modelo	Motor	Años	Doble Iridio		Iridio		Doble Platino		Platino		Super 4		Níquel	
			Fórmula	Nº. de Parte	Fórmula	Nº. de Parte	Fórmula	Nº. de Parte	Fórmula	Nº. de Parte	Fórmula	Nº. de Parte	Fórmula	Nº. de Parte
500	L4 1.4L Turbo	2012-2017	YR5DII33S	0242145571										
500L	L4 1.4L	2015-2019	YR5DII33S	0242145571										
500X	L4 2.4L	2016-2017	FR8SII332X	0242230618										
Idea	L4 1.8L	2008-2009									WR78	0242232504	WR7DC+	0242235663
Palio	L4 1.6L	2004-2005									FR78X	0242232502	FR8DC+	0242229659
	L4 1.8L	2005-2009									WR78	0242232504	WR7DC+	0242235663
Punto	L4 1.4L	2007-2009			YR6KI332S	0242140514								
Stilo	L5 2.4L	2007-2007									FR78X	0242232502	FR7LDC+	0242235668
Strada	L4 1.8L	2007-2008									WR78	0242232504	WR7DC+	0242235663

FORD

Aerostar	V6 3.0L	1991-1992	HR7DII33V	0242236594			HR7DPP33V	0242236625	HR7DPP30V	0242236658			HR8DCX+	0242229775
	V6 4.0L	1993-1995	HR8DII33X	0242230524			HR8DPP33V	0242230583	HR8DPP30V	0242230561			HR8DCX+	0242229775
		1993-1995	HR8KII33V	0242230535			HR8DPP33X	0242230588	HR8DPP30X	0242230569				
B-150	V8 5.0L	1981-1985	HR9BII33V	0242225665					HR9BPP30X	0242225673				
Club Wagon	V8 5.4L	1998-1998	HR7KII33V	0242236603			HR7DPP33Y	0242236628	HR7DPP30Y	0242236613				
		1997-1997	HR7DII33V	0242236594			HR7DPP33V	0242236625	HR7DPP30V	0242236658				
	V8 5.8L	1995-1996							HR7BPP30X	0242236615				
Contour	L4 2.0L	1996-1996	HR7NII33X	0242236591			HR7MPP33X	0242236629	HR7NPP30V	0242236672				
	V6 2.5L	1996-2000	HR7KII33V	0242236603			HR7DPP33V	0242236625	HR7DPP30V	0242236658				
Cougar	V6 3.8L	1990-1994	HR8JII33V	0242230555			HR8JPP33V	0242230589	HR8JPP302V	0242230563				
	V8 4.6L	1995-1995	HR7DII33V	0242236594			HR7DPP33V	0242236625	HR7DPP30V	0242236658			HR8DCX+	0242229775
Courier	L4 1.6L	2001-2012											HR7MCU	0242235657
Crown Victoria	V8 4.6L	2011-2011	HR8DII33X	0242230524			HR8DPP33X	0242230588	HR8DPP30X	0242230569				
		2009-2011											HR8DCX+	0242229775
		2000-2008					HR7DPP33V	0242236625						
		2000-2000	HR6KII33X	0242240671										
		1998-2008	HR7DII33V	0242236594					HR7DPP30V	0242236658				
	1998-2000												HR9DCY+	0242225623
E-150	V6 4.2L	2002-2003	HR8JII33V	0242230555			HR8JPP33V	0242230589	HR8JPP302V	0242230563				
	V8 4.6L	2004-2008	HR7DII33V	0242236594			HR7DPP33V	0242236625	HR7DPP30V	0242236658				
	V8 5.4L	2002-2007	HR7KII33V	0242236603			HR7DPP33Y	0242236628	HR7DPP30Y	0242236613				











F

 Marca / Modelo	 Motor	 Años	 Doble Iridio		 Iridio		 Doble Platino		 Platino		 Super 4		 Níquel	
			Fórmula	Nº. de Parte	Fórmula	Nº. de Parte	Fórmula	Nº. de Parte	Fórmula	Nº. de Parte	Fórmula	Nº. de Parte	Fórmula	Nº. de Parte
Expedition	V8 4.6L	1997-2004					HR7DPP33V	0242236625	HR7DPP30V	0242236658				
		1997-2000	HR7KII33V	0242236603										
	V8 5.4L	2008-2014	AR7TII330U	0242135565										
		2002-2002	HR6KII33X	0242240671			HR6DPP33X	0242240688						
		1998-2008							HR7DPP30Y	0242236613				
		1998-2004	HR7KII33V	0242236603			HR7DPP33Y	0242236628						
		1997-2002							HR7DPP30V	0242236658				
1997-1997	HR7DII33V	0242236594			HR7DPP33V	0242236625								
Explorer	V6 3.5L	2011-2019							HR7NPP30V	0242236672				
		2011-2017					HR7MPP33X	0242236629						
	V6 4.0L	2005-2010	HR8JII33V	0242230555			HR8JPP33V	0242230589	HR8JPP302V	0242230563				
		1997-2005	HR7DII33V	0242236594			HR7DPP33V	0242236625	HR7DPP30V	0242236658				
		1991-2010											HR8DCX+	0242229775
		1991-1996	HR8KII33V	0242230535			HR8DPP33V	0242230583	HR8DPP30V	0242230561				
	1991-1995	HR8DII33X	0242230524			HR8DPP33X	0242230588	HR8DPP30X	0242230569					
	V8 4.6L	2008-2010	AR7TII330U	0242135565										
		2002-2005	HR7DII33V	0242236594			HR7DPP33V	0242236625	HR7DPP30V	0242236658				
	V8 5.0L	1996-2001	HR7KII33V	0242236603			HR7DPP33V	0242236625	HR7DPP30V	0242236658				
Explorer Sport	V6 4.0L	2001-2003	HR7DII33V	0242236594			HR7DPP33V	0242236625	HR7DPP30V	0242236658				
Explorer Sport Trac	V8 4.6L	2008-2010	AR7TII330U	0242135565										
F-100	V8 5.0L	1978-1979	HR9BII33V	0242225665					HR9BPP30X	0242225673			HR9BC+	0242225622
F-100 Ranger	L4 2.3L	2001-2001	HR8DII33X	0242230524			HR8DPP33X	0242230588	HR8DPP30X	0242230569			HR8DCX+	0242229775
		1996-2001												
	1996-1997	HR7KII33V	0242236603			HR7DPP33V	0242236625	HR7DPP30V	0242236658					
	L4 2.5L	1998-2000	HR7KII33V	0242236603			HR7DPP33V	0242236625	HR7DPP30V	0242236658			HR8DCX+	0242229775
	V6 3.0L	2000-2000	HR7DII33V	0242236594			HR6DPP33X	0242240688						
1997-2001		HR7KII33V	0242236603			HR7DPP33V	0242236625	HR7DPP30V	0242236658					
F-150	V6 3.3L	2018-2020							HR7NPP30V	0242236672				
	V6 3.5L	2015-2017							HR7NPP30V	0242236672				
	V6 3.7L	2011-2014							HR7NPP30V	0242236672				
	V6 4.2L	1998-2008	HR8JII33V	0242230555			HR8JPP33V	0242230589	HR8JPP302V	0242230563				
	V8 5.0L	2011-2017	HR7NII33X	0242236591			HR7MPP33X	0242236629	HR7MPP30X	0242236617				













Marca / Modelo	Motor	Años	Doble Iridio		Iridio		Doble Platino		Platino		Super 4		Níquel	
			Fórmula	Nº. de Parte	Fórmula	Nº. de Parte	Fórmula	Nº. de Parte	Fórmula	Nº. de Parte	Fórmula	Nº. de Parte	Fórmula	Nº. de Parte
F-150	V8 5.0L	1984-1985							HR7BPP30X	0242236615				
		1980-1985	HR9BII33V	0242225665										
		1980-1983							HR9BPP30X	0242225673				
	V8 5.8L	1984-1985							HR9BPP30X	0242225673				
		1984-1985	HR9BII33V	0242225665					HR7BPP30X	0242236615				
F-200	V8 5.0L	1986-1991							HR7BPP30X	0242236615				
F-250	V8 4.6L	2000-2009	HR7DII33V	0242236594										
		1997-2009					HR7DPP33V	0242236625	HR7DPP30V	0242236658				
		1997-2001	HR7KII33V	0242236603										
	V8 5.0L	1992-1997	HR9BII33V	0242225665					HR9BPP30X	0242225673				
		1992-1995							HR7BPP30X	0242236615				
	V8 5.4L	2001-2001	HR7KII33V	0242236603			HR7DPP33Y	0242236628	HR7DPP30Y	0242236613				
	V8 5.8L	1997-1997	HR9BII33V	0242225665					HR9BPP30X	0242225673				
1992-1996								HR7BPP30X	0242236615					
F-350	V8 5.0L	1984-1992							HR7BPP30X	0242236615				
		1980-1998	HR9BII33V	0242225665					HR9BPP30X	0242225673				
		1975-1981											HR9BC+	0242225622
	V8 5.4L	2008-2009	AR7TII330U	0242135565										
		2002-2003											HR8DCX+	0242229775
	V8 5.8L	1999-2004	HR7KII33V	0242236603				HR7DPP33Y	0242236628	HR7DPP30Y	0242236613			
	V8 6.2L	1995-1996							HR7BPP30X	0242236615				
V8 6.2L	2011-2016						HR6MPP33X	0242240706						
F-350 Super Duty	V8 5.4L	2008-2009	AR7TII330U	0242135565										
		2002-2004	HR7KII33V	0242236603				HR7DPP33Y	0242236628	HR7DPP30Y	0242236613			
	V8 6.2L	2017-2020						HR6MPP33X	0242240706					
		2017-2018							HR7MPP30X	0242236617				
F-450 Super Duty	V10 6.8L	2008-2019	AR7TII330U	0242135565										
		1999-2004	HR7KII33V	0242236603				HR7DPP33Y	0242236628	HR7DPP30Y	0242236613			
F-550 Super Duty	V10 6.8L	2008-2018	AR7TII330U	0242135565										
		2001-2004	HR7KII33V	0242236603				HR7DPP33Y	0242236628	HR7DPP30Y	0242236613			
Fairmont	V8 5.0L	1980-1983	HR9BII33V	0242225665					HR9BPP30X	0242225673				
Fiesta	L4 1.3L	1998-2001											HR7DCX+	0242236560
	L4 1.4L	1998-2000							HR8MPP30V	0242230601			HR8MCV+	0242229785

 Marca / Modelo	 Motor	 Años	 Doble Iridio		 Iridio		 Doble Platino		 Platino		 Super 4		 Níquel		
			Fórmula	Nº. de Parte	Fórmula	Nº. de Parte	Fórmula	Nº. de Parte	Fórmula	Nº. de Parte	Fórmula	Nº. de Parte	Fórmula	Nº. de Parte	Fórmula
Fiesta	L4 1.6L	2014-2014	HR7TII3320T	0242236683											
		2011-2019	HR7NII332S	0242236675											
		2003-2010												HR7MCU	0242235657
		2003-2003								HR8MPP30V	0242230601				
	L4 1.6L Turbo	2019-2019	HR7NII332S	0242236675											
		2015-2019	HR7TII3320T	0242236683											
Fiesta Ikon	L4 2.0L	2008-2008	HR8DII33X	0242230524			HR8DPP33V	0242230583	HR8DPP30V	0242230561					
		2002-2013							HR8MPP30X	0242230564					
Five Hundred	L4 1.6L	2002-2004											HR8MCV+	0242229785	
		2005-2007	HR7KII33V	0242236603			HR7DPP33Y	0242236628	HR7DPP30Y	0242236613					
Focus	L4 2.0L	2013-2013	HR7NII332S	0242236675											
		2008-2010					HR6DPP33V	0242240620							
		2005-2011	HR8KII33V	0242230535			HR8DPP33V	0242230583	HR8DPP30V	0242230561					
		2000-2004	HR8JII33V	0242230555			HR8JPP33V	0242230589	HR8JPP302V	0242230563					
		2000-2004	HR7NII33X	0242236591			HR7MPP33X	0242236629	HR7MPP30X	0242236617					
	L4 2.0L Turbo	2014-2015	HR7NII332S	0242236675											
	L5 2.5L	2011-2011							FR7MPP10	0242235743					
2010-2011				FR7NI33	0242236528										
Freestar	V6 4.2L	2004-2007	HR8KII33V	0242230535			HR8DPP33V	0242230583	HR8DPP30V	0242230561					
Fusion	L4 2.0L	2019-2019	HR7NII332S	0242236675											
		2017-2020	HR8MII33V	0242230612											
		2013-2018			HR7MII30T	0242236678									
	L4 2.3L	2007-2009	HR8MII33V	0242230612					HR8NPP302X	0242230573					
		2010-2018	HR8MII33V	0242230612											
	L4 2.5L	2010-2013							HR8NPP302X	0242230573					
		2010-2012	HR8KII33V	0242230535			HR8DPP33V	0242230583	HR8DPP30V	0242230561					
	V6 3.0L	2006-2009	HR7KII33V	0242236603			HR7DPP33Y	0242236628	HR7DPP30Y	0242236613					
2011-2012		HR7NII33X	0242236591			HR7MPP33X	0242236629	HR7NPP30V	0242236672						
Ghia	V6 3.0L	1991-1994	HR7DII33V	0242236594			HR7DPP33V	0242236625	HR7DPP30V	0242236658					
Grand Marquis	V8 4.6L	1995-1999	HR7KII33V	0242236603									HR9DCY+	0242225623	
		1992-2004	HR7DII33V	0242236594			HR7DPP33V	0242236625	HR7DPP30V	0242236658					
		1992-1994											HR8DCX+	0242229775	
GT	V6 3.5L	2017-2017	HR7NII332S	0242236675											





 Marca / Modelo	 Motor	 Años	 Doble Iridio		 Iridio		 Doble Platino		 Platino		 Super 4		 Níquel		
			Fórmula	Nº. de Parte	Fórmula	Nº. de Parte	Fórmula	Nº. de Parte	Fórmula	Nº. de Parte	Fórmula	Nº. de Parte	Fórmula	Nº. de Parte	
Ikona	L4 1.6L	2003-2007							HR8MPP30V	0242230601			HR8MCV+	0242229785	
Ka	L4 1.6L	2001-2008							HR8MPP30X	0242230564			HR8MCV+	0242229785	
Lobo	V8 4.6L	2009-2010	AR7TII330U	0242135565			HR8DPP33X	0242230588	HR8DPP30X	0242230569			HR8DCX+	0242229775	
		2009-2010	HR8DII33X	0242230524											
		2000-2008	HR7DII33V	0242236594											
		1997-2008					HR7DPP33V	0242236625	HR7DPP30V	0242236658					
		1997-2001	HR7KII33V	0242236603											
	V8 5.0L	2011-2017							HR7NPP30V	0242236672					
	V8 5.4L	2002-2002	HR6KII33X	0242240671			HR6DPP33X	0242240688	HR7DPP30V	0242236658					
		2001-2010	AR7TII330U	0242135565											
		1999-2003	HR7KII33V	0242236603			HR7DPP33Y	0242236628	HR7DPP30Y	0242236613					
	V8 5.4L Supercargado	2001-2001	HR6KII33X	0242240671			HR6DPP33X	0242240688	HR7DPP30V	0242236658					
V8 6.2L	2011-2014					HR6MPP33X	0242240706	HR7MPP30X	0242236617						
LTD	V8 5.8L	1980-1980	HR9BII33V	0242225665					HR9BPP30X	0242225673					
Mondeo	V6 2.5L	2001-2007	HR8NII332X	0242230530					HR8DPP15V	0242229652					
	V6 3.0L	2004-2005							HR8DPP15V	0242229652					
Mustang	L4 2.3L	2016-2019			HR7MII30T	0242236678									
	V6 3.7L	2011-2017							HR7NPP30V	0242236672					
	V8 4.0L	2007-2010	HR8JII33V	0242230555				HR8JPP33V	0242230589	HR8JPP302V	0242230563				
		2008-2010	AR7TII330U	0242135565											
		1999-2004	HR7DII33V	0242236594											
		1999-2001					HR7DPP33Y	0242236628	HR7DPP30Y	0242236613					
		1996-2004					HR7DPP33V	0242236625	HR7DPP30V	0242236658					
	1996-2001	HR7KII33V	0242236603									HR9DCY+	0242225623		
	V8 5.0L	2017-2019								HR7NPP30V	0242236672				
		2011-2017	HR7NII33X	0242236591				HR7MPP33X	0242236629						
		2011-2013								HR7MPP30X	0242236617				
		1994-1994	HR7DII33V	0242236594				HR7DPP33V	0242236625	HR7DPP30V	0242236658			HR8DCX+	0242229775
		1979-1995	HR9BII33V	0242225665						HR9BPP30X	0242225673				
2016-2017		HR7NII33X	0242236591												
V8 5.4L	2008-2012	HR6KII33X	0242240671			HR6DPP33X	0242240688	HR7DPP30V	0242236658						
Mystique	V6 2.5L	1995-2000	HR7KII33V	0242236603			HR7DPP33V	0242236625	HR7DPP30V	0242236658					

Marca / Modelo	Motor	Años	Doble Iridio		Iridio		Doble Platino		Platino		Super 4		Níquel	
			Fórmula	Nº. de Parte	Fórmula	Nº. de Parte	Fórmula	Nº. de Parte	Fórmula	Nº. de Parte	Fórmula	Nº. de Parte	Fórmula	Nº. de Parte
P-350	V8 5.8L	1986-1997							HR7BPP30X	0242236615				
P-400	V8 5.0L	1975-1975	HR9BII33V	0242225665					HR9BPP30X	0242225673				
Ranger	L4 2.3L	2011-2011	HR8KII33V	0242230535			HR8DPP33V	0242230583	HR8DPP30V	0242230561				
		2002-2012	HR8DII33X	0242230524			HR8DPP33X	0242230588	HR8DPP30X	0242230569				
		2002-2009											HR8DCX+	0242229775
	V6 3.0L	2002-2002	HR7KII33V	0242236603			HR7DPP33V	0242236625	HR7DPP30V	0242236658				
Taurus	V6 3.8L	1988-1991							HR8JPP302V	0242230563				
Thunderbird	V6 3.8L	1991-1994	HR8JII33V	0242230555			HR8JPP33V	0242230589	HR8JPP302V	0242230563				
	V6 3.8L Supercargado	1990-1990	HR8JII33V	0242230555			HR8JPP33V	0242230589	HR8JPP302V	0242230563				
	V8 3.9L	2003-2003	FR7KII33X	0242236599			FR7DPP33X	0242236631	FR7DPP30X	0242236616				
	V8 4.6L	1996-1996	HR7KII33V	0242236603										
		1994-1996					HR7DPP33V	0242236625	HR7DPP30V	0242236658				
		1994-1995	HR7DII33V	0242236594									HR8DCX+	0242229775
V8 5.0L	1991-1993	HR9BII33V	0242225665					HR9BPP30X	0242225673					
Topaz	L4 2.3L	1988-1994	HR8DII33X	0242230524			HR8DPP33X	0242230588	HR8DPP30X	0242230569			HR8DCX+	0242229775
		1984-1987	HR7DII33V	0242236594			HR7DPP33V	0242236625						
Transit	V6 3.7L	2015-2019							HR7NPP30V	0242236672				
Windstar	V6 3.8L	1995-2003	HR8KII33V	0242230535			HR8DPP33V	0242230583	HR8DPP30V	0242230561				









GEO

Tracker	L4 1.6L	1994-1994											FR7DCX+	0242235667
		1993-1994							WR8DPP30W	0242230599			WR9DC+	0242225599
		1993-1993											WR8DC+	0242229656

GMC

Acadia	V6 3.6L	2009-2009	HR8NII332X	0242230530					HR8NPP302	0242229739				
		2007-2016	HR7NII33X	0242236591			HR7MPP33X	0242236629	HR7MPP30X	0242236617				
Canyon	L5 3.7L	2007-2012	HR8MII33X	0242230611			HR8MPP33X	0242230582	HR8MPP30X	0242230564				
Sierra	V8 5.3L	2014-2020	HR8SII33W	0242230615										
		2007-2018					HR8LPP33U	0242230577	HR8LPP30U	0242230558				
		2007-2013	HR8LII33U	0242230523										
	V8 6.2L	2014-2020	HR8SII33W	0242230615										



 Marca / Modelo	 Motor	 Años	 Doble Iridio		 Iridio		 Doble Platino		 Platino		 Super 4		 Níquel	
			Fórmula	Nº. de Parte	Fórmula	Nº. de Parte	Fórmula	Nº. de Parte	Fórmula	Nº. de Parte	Fórmula	Nº. de Parte	Fórmula	Nº. de Parte
Civic	L4 1.6L	1999-1999	FR7DII33X	0242236596			FR7DPP33X	0242236631	FR7DPP30X	0242236616				
		1997-2000	FR8LII33X	0242230531			FR8LPP33X	0242230580	FR7LPP30X	0242236614	FR78X	0242232502	FR8LCX	0242229576
		1997-2000							FR8LPP30X	0242230560				
		1997-1999	FR7LII33X	0242236592			FR7LPP33X	0242236626					FR7LCX+	0242236542
	L4 1.7L	2003-2003											FR7LCX+	0242236542
		2002-2005									FR78X	0242232502		
	L4 1.8L	2001-2005	FR7LII33X	0242236592			FR7LPP33X	0242236626	FR7LPP30X	0242236614				
		2015-2015	YR7SII3520X*	0242135557*										
	L4 2.0L	2006-2015	FR6LII330X	0242240675			FR6LPP330X	0242240687	FR6LPP300X	0242240683				
2016-2020		VR6NII352U*	0242140555*											
2007-2011		FR6KII33X	0242240669											
L4 2.4L	2012-2015	YR6SII330X	0242140523											
Crosstour	V6 3.5L	2012-2014	YR6SII330X	0242140523										
CR-V	L4 2.4L	2015-2019	VR6NII352U*	0242140555*										
		2010-2011	YR6SII330X	0242140523										
		2002-2009	FR6LII330X	0242240675			FR6LPP330X	0242240687	FR6LPP300X	0242240683	FR78X	0242232502		
		2002-2006			FR6KI332S	0242240653								
Fit	L4 1.5L	2017-2020	VR7SII350U*	0242135570*										
		2014-2014	FR6LII330X	0242240675										
		2007-2016	FR6LII330V	0242240691										
		2007-2013					FR6LPP330X	0242240687	FR6LPP300X	0242240683				
		2006-2006	FR7LII33X	0242236592			FR7LPP33X	0242236626	FR7LPP30X	0242236614			FR7DCX+	0242235667
HR-V	L4 1.8L	2016-2020	YR7SII3520X*	0242135557*										
Odyssey	V6 3.5L	2011-2020	YR7SII3520X*	0242135557*										
		2008-2009	YR6SII330X	0242140523										
		2005-2010	FR7LII33X	0242236592			FR7LPP33X	0242236626	FR7LPP30X	0242236614				
		2000-2004	FR8LII33X	0242230531			FR8LPP33X	0242230580	FR8LPP30X	0242230560				
Pilot	V6 3.5L	2012-2021	YR7SII3520X*	0242135557*										
		2012-2013	HR8LII33U	0242230523										
		2009-2011	YR6SII330X	0242140523										
		2005-2008	FR7LII33X	0242236592			FR7LPP33X	0242236626	FR7LPP30X	0242236614				
		2003-2004	FR8LII33X	0242230531			FR8LPP33X	0242230580	FR8LPP30X	0242230560				



Marca / Modelo	Motor	Años	Doble Iridio		Iridio		Doble Platino		Platino		Super 4		Níquel	
			Fórmula	Nº. de Parte	Fórmula	Nº. de Parte	Fórmula	Nº. de Parte	Fórmula	Nº. de Parte	Fórmula	Nº. de Parte	Fórmula	Nº. de Parte
Ridgeline	V6 3.5L	2009-2014	YR6SII330X	0242140523										
		2007-2008	FR7LII33X	0242236592			FR7LPP33X	0242236626	FR7LPP30X	0242236614				

HUMMER









H2	V8 6.0L	2005-2007	HR8LI33U	0242230523			HR8LPP33U	0242230577	HR8LPP30U	0242230558				
	V8 6.2L	2008-2009	HR8LI33U	0242230523			HR8LPP33U	0242230577	HR8LPP30U	0242230558				
H3	L5 3.5L	2006-2006	HR8MII33X	0242230611			HR8MPP33X	0242230582	HR8MPP30X	0242230564				
	L5 3.7L	2007-2010	HR8MII33X	0242230611			HR8MPP33X	0242230582	HR8MPP30X	0242230564				
	V8 5.3L	2008-2009	HR8LI33U	0242230523			HR8LPP33U	0242230577	HR8LPP30U	0242230558				
H3T	L5 3.7L	2010-2010	HR8MII33X	0242230611			HR8MPP33X	0242230582	HR8MPP30X	0242230564				

HYUNDAI

Accent	L4 1.6L	2018-2019	YR8SII33U	0242129524									YR8SEU	0242129515
Elantra	L4 1.8L	2015-2016	YR7SII33U	0242135548										
	L4 2.0L	2017-2020	YR7SII33U	0242135548										
Grand i10	L4 1.2L	2018-2021	YR7MII33X	0242135554										
Ioniq	L4 1.6L	2018-2019	YR7NII33S	0242135533										
Santa Fe	L4 2.0L	2019-2019	YR7SII33T	0242135556										
	V6 3.3L	2018-2018	YR7SII33U	0242135548										
Santa Fe Sport	L4 2.0L	2017-2018	YR7SII33T	0242135556										
Santa Fe XL	V6 3.3L	2019-2019	YR7SII33U	0242135548										
Sonata	L4 2.0L	2016-2018	YR7SII33T	0242135556										
	L4 2.4L	2015-2018	YR7SII33X	0242135564										
Tucson	L4 2.0L	2016-2020	YR7SII33U	0242135548										
	L4 2.4L	2019-2020	YR7SII33X	0242135564										

INFINITI

FX35	V6 3.5L	2012-2012	VR6NII35U*	0242140550*										
FX37	V6 3.7L	2013-2013	VR6NII35U*	0242140550*										
FX50	V8 5.0L	2012-2013	VR6NII35U*	0242140550*										
G37	V6 3.7L	2012-2013	VR6NII35U*	0242140550*										
I30	V6 3.0L	1998-2001	FR8KII33X	0242230528			FR8DPP33X	0242230579	FR8DPP30X	0242230557				
		1998-2001	FR7KII33X	0242236599			FR7DPP33X	0242236631	FR7DPP30X	0242236616				









 Marca / Modelo	 Motor	 Años	 Doble Iridio		 Iridio		 Doble Platino		 Platino		 Super 4		 Níquel	
			Fórmula	Nº. de Parte	Fórmula	Nº. de Parte	Fórmula	Nº. de Parte	Fórmula	Nº. de Parte	Fórmula	Nº. de Parte	Fórmula	Nº. de Parte
I35	V6 3.5L	2002-2003	FR8MII33X	0242230533			FR8MPP33X	0242230584	FR8MPP30X	0242230562				
		2002-2003	FR7NII33X	0242236593			FR7MPP33X	0242236630	FR7NPP30X	0242236619				
JX35	V6 3.5L	2013-2013	VR6NII35U*	0242140550*										
M37	V6 3.7L	2012-2013	VR6NII35U*	0242140550*										
M56	V8 5.6L	2012-2013	VR6NII35U*	0242140550*										
Q45	V8 4.1L	1997-2001	FR7KII33X	0242236599			FR7DPP33X	0242236631	FR7DPP30X	0242236616	FR78X	0242232502		
		1997-2001	FR8KII33X	0242230528			FR8DPP33X	0242230579	FR8DPP30X	0242230557				
	V8 4.5L	2002-2006	FR8MII33X	0242230533			FR8MPP33X	0242230584	FR8MPP30X	0242230562				
		2002-2006	FR7NII33X	0242236593			FR7MPP33X	0242236630	FR7NPP30X	0242236619				
		1994-1995	FR8KII33X	0242230528			FR8DPP33X	0242230579	FR8DPP30X	0242230557				
		1994-1995	FR7KII33X	0242236599			FR7DPP33X	0242236631	FR7DPP30X	0242236616				
		1994-1995	FR6KII33X	0242240669			FR6KPP33X+	0242240649						
Q50	V6 3.0L	2017-2017	VR6NII35U*	0242140550*										
	V6 3.5L	2015-2020	VR6NII35U*	0242140550*										
	V6 3.7L	2015-2018	VR6NII35U*	0242140550*										
Q60	V6 3.0L	2017-2017	VR6NII35U*	0242140550*										
	V6 3.7L	2014-2016	VR6NII35U*	0242140550*										
Q70	V6 3.7L	2014-2019	VR6NII35U*	0242140550*										
	V8 5.6L	2014-2019	VR6NII35U*	0242140550*										
QX56	V8 5.6L	2012-2013	VR6NII35U*	0242140550*										
QX60	L4 2.5L	2015-2019	VR6NII35U*	0242140550*										
	V6 3.5L	2014-2019	VR6NII35U*	0242140550*										
QX70	V6 3.7L	2014-2020	VR6NII35U*	0242140550*										
	V8 5.0L	2014-2016	VR6NII35U*	0242140550*										
QX80	V8 5.6L	2014-2020	VR6NII35U*	0242140550*										

JAGUAR

F-Pace	V8 5.0L	2019-2019	VR7MII33U	0242135569										
F-Type	V8 5.0L	2014-2019	VR7MII33U	0242135569										





 Marca / Modelo	 Motor	 Años	 Doble Iridio		 Iridio		 Doble Platino		 Platino		 Super 4		 Níquel	
			Fórmula	Nº. de Parte	Fórmula	Nº. de Parte	Fórmula	Nº. de Parte	Fórmula	Nº. de Parte	Fórmula	Nº. de Parte	Fórmula	Nº. de Parte
S-Type	V6 3.0L	2001-2007	HR7DII33V	0242236594			HR7DPP33V	0242236625	HR7DPP30V	0242236658				
	V8 4.0L	2000-2002	FR8DII33X	0242230534			FR7DPP33X	0242236631	FR7DPP30X	0242236616				
		2008-2008					FR8DPP33X	0242230579	FR8DPP30X	0242230557				
	V8 4.2L	2003-2008	FR8DII33X	0242230534										
		2003-2007					FR7DPP33X	0242236631	FR7DPP30X	0242236616				
Super V8	V8 4.2L	2008-2009					FR8DPP33X	0242230579	FR8DPP30X	0242230557				
		2005-2009	FR8DII33X	0242230534										
		2005-2007					FR7DPP33X	0242236631	FR7DPP30X	0242236616				
Vanden Plas	V8 4.0L	2001-2001	FR7KII33X	0242236599										
		1998-2003	FR8DII33X	0242230534					FR7DPP30X	0242236616				
	V8 4.2L	2008-2009					FR8DPP33X	0242230579	FR8DPP30X	0242230557				
		2004-2009	FR8DII33X	0242230534										
	2004-2007					FR7DPP33X	0242236631	FR7DPP30X	0242236616					
XE	L4 2.0L	2016-2017	HR7NII332S	0242236675										
XF	L4 2.0L	2013-2015	HR7NII332S	0242236675										
	V8 4.2L	2009-2010	FR8DII33X	0242230534			FR8DPP33X	0242230579	FR8DPP30X	0242230557				
	V8 4.2L Supercargado	2009-2009			FR6KI332S	0242240653								
	V8 5.0L	2010-2012	VR7MII33U	0242135569										
XFR	V8 5.0L	2010-2015	VR7MII33U	0242135569										
XJ	V8 5.0L	2011-2015	VR7MII33U	0242135569										
XJ8	V8 4.0L	2003-2003					FR7DPP33X	0242236631						
		2002-2003										FR8DCX+	0242229660	
		1999-2003	FR8DII33X	0242230534					FR7DPP30X	0242236616				
	V8 4.2L	2008-2009					FR8DPP33X	0242230579	FR8DPP30X	0242230557				
		2005-2009	FR8DII33X	0242230534										
	2005-2007					FR7DPP33X	0242236631	FR7DPP30X	0242236616					
XJR	V8 4.0L	2002-2003	FR8DII33X	0242230534			FR7DPP33X	0242236631						
		1999-2003							FR7DPP30X	0242236616				
		1999-2001	FR7KII33X	0242236599										
	V8 4.2L	2008-2009							FR8DPP30X	0242230557				
		2006-2009	FR8DII33X	0242230534										
	2006-2007							FR7DPP30X	0242236616					

Marca / Modelo	Motor	Años	Doble Iridio		Iridio		Doble Platino		Platino		Super 4		Níquel	
			Fórmula	Nº. de Parte	Fórmula	Nº. de Parte	Fórmula	Nº. de Parte	Fórmula	Nº. de Parte	Fórmula	Nº. de Parte	Fórmula	Nº. de Parte
XK	V8 4.2L	2007-2007	FR8DII33X	0242230534			FR7KPP33U+	0242236544	FR7DPP30X	0242236616				
	V8 5.0L	2010-2010	VR7MII33U	0242135569										
XK8	V8 4.0L	1998-2002	FR8DII33X	0242230534			FR7DPP33X	0242236631	FR7DPP30X	0242236616				
	V8 4.2L	2003-2004	FR8DII33X	0242230534			FR7DPP33X	0242236631	FR7DPP30X	0242236616				
XKR	V8 4.0L	2000-2002	FR7KII33X	0242236599			FR7DPP33X	0242236631	FR7DPP30X	0242236616				
	V8 4.2L	2008-2009					FR7KPP33U+	0242236544						
		2005-2009	FR8DII33X	0242230534										
		2005-2006			FR6KI332S	0242240653	FR7DPP33X	0242236631	FR7DPP30X	0242236616				
V8 5.0L	2010-2013	VR7MII33U	0242135569											
XKR-S	V8 5.0L	2014-2014	VR7MII33U	0242135569										
X-Type	V6 2.5L	2002-2005	HR7DII33V	0242236594			HR7DPP33V	0242236625	HR7DPP30V	0242236658				
	V6 3.0L	2002-2008	HR7DII33V	0242236594			HR7DPP33V	0242236625	HR7DPP30V	0242236658				

JEEP

Cherokee	L4 2.4L	2014-2017	FR8SII332X	0242230618										
	L6 4.0L	1993-2001	FR8VII33U	0242230532			FR8VPP33U	0242230585	FR8VPP30U	0242230565				
	V6 3.2L	2014-2019	YR7SII3320U	0242135574	YR7SII302U	0242135555								
CJ5	L6 4.2L	1975-1977											WR9DC+	0242225599
Commander	V8 4.7L	2010-2010			FR8TI332	0242229764							FR8TE2	0242229765
		2006-2007	FR8KII332X	0242230556					FR8LPP302X	0242230570			FR8LCX	0242229576
		2009-2010											FR8SEX	0242230624
		2009-2009	FR8SII33X	0242230571			FR8SPP33X	0242230604	FR8SPP30X	0242230576				
		2006-2008	HR9SII330X	0242225664			HR9SPP330X	0242225680	HR9SPP300X	0242225672			HR9SE0X	0242225668
Compass	L4 2.4L	2018-2019	FR8SII332X	0242230618										
		2007-2017	FR8LII33X	0242230531			FR8LPP33X	0242230580	FR8LPP30X	0242230560			FR8LCX	0242229576
Grand Cherokee	L6 4.0L	1993-2004	FR8VII33U	0242230532			FR8VPP33U	0242230585	FR8VPP30U	0242230565				
	V6 3.6L	2017-2017	FR8SII33X	0242230571			FR8SPP33X	0242230604	FR8SPP30X	0242230576				
		2011-2019	YR7SII3320U	0242135574										
		2011-2016			YR7SII302U	0242135555								
	V6 3.7L	2005-2010	FR7LII33X	0242236592					FR8LPP302X	0242230570	FR78X	0242232502	FR7LCX+	0242236542
	V8 4.7L	2008-2009			FR8TI332	0242229764							FR8TE2	0242229765
		2001-2009									FR78X	0242232502		
1999-2009	FR8KII332X	0242230556					FR8LPP302X	0242230570						



 Marca / Modelo	 Motor	 Años	 Doble Iridio		 Iridio		 Doble Platino		 Platino		 Super 4		 Níquel	
			Fórmula	Nº. de Parte	Fórmula	Nº. de Parte	Fórmula	Nº. de Parte	Fórmula	Nº. de Parte	Fórmula	Nº. de Parte	Fórmula	Nº. de Parte
Rio	L4 1.6L	2020-2020											YR8SEU	0242129515
		2016-2020	YR8SII33U	0242129524										
Sedona	V6 3.3L	2019-2019	YR7SII33X	0242135564										
Sorento	L4 2.4L	2020-2020	YR7SII33X	0242135564										
		2016-2019	YR7SII33U	0242135548										
	V6 3.3L	2020-2020	YR7SII33X	0242135564										
		2016-2019	YR7SII33U	0242135548										
Soul	L4 1.6L	2016-2020	YR8SII33U	0242129524										
	L4 2.0L	2016-2020	YR7SII33U	0242135548										
Sportage	L4 2.0L	2016-2019	YR7SII33T	0242135556										
	L4 2.4L	2017-2020	YR7SII33X	0242135564										
	V6 3.3L	2016-2016	YR7SII33U	0242135548										

LAND ROVER

Discovery	V8 4.0L	1999-2002	FR8DII33X	0242230534			FR8DPP33X	0242230579	FR8DPP30X	0242230557				
		1998-2002									WR78	0242232504		
		1998-1999											WR8DC+	0242229656
	V8 4.6L	2003-2004	FR8DII33X	0242230534			FR8DPP33X	0242230579	FR8DPP30X	0242230557				
		2003-2003									WR78	0242232504	WR7DC+	0242235663
Discovery Sport	L4 2.0L	2015-2017	HR7NII332S	0242236675										
Freelander	L4 1.8L	1999-2001					FR7KPP33U+	0242236544						
	V6 2.5L	2002-2006	FR7DII33X	0242236596	FR6KI332S	0242240653	FR7KPP33U+	0242236544	FR7DPP30X	0242236616				
LR2	L4 2.0L	2013-2015	HR7NII332S	0242236675										
	L6 3.2L	2008-2012			FR7NI33	0242236528								
LR3	V8 4.4L	2007-2008					FR8DPP33X	0242230579	FR8DPP30X	0242230557				
		2005-2008	FR8DII33X	0242230534										
LR4	V8 5.0L	2010-2013	VR7MII33U	0242135569										
Range Rover	V8 4.2L	2007-2009							FR8DPP30X	0242230557				
		2006-2009	FR8DII33X	0242230534			FR8DPP33X	0242230579						
	V8 4.4L	2007-2009							FR8DPP30X	0242230557				
		2006-2009	FR8DII33X	0242230534			FR8DPP33X	0242230579						
		2003-2005						FGR7DQP+	0242236562	FR78X	0242232502	FR7LDC+	0242235668	





Marca / Modelo	Motor	Años	Doble Iridio		Iridio		Doble Platino		Platino		Super 4		Níquel	
			Fórmula	Nº. de Parte	Fórmula	Nº. de Parte	Fórmula	Nº. de Parte	Fórmula	Nº. de Parte	Fórmula	Nº. de Parte	Fórmula	Nº. de Parte
Range Rover	V8 4.6L	2000-2001					FR8DPP33X	0242230579						
		1997-2001											WR8DC+	0242229656
	V8 5.0L	2010-2017	VR7MII33U	0242135569										
	V8 5.0L Supercargado	2013-2013	VR7MII33U	0242135569										
Range Rover Evoque	L4 2.0L	2012-2017	HR7NII332S	0242236675										
Range Rover Sport	V8 4.2L	2007-2009					FR8DPP33X	0242230579	FR8DPP30X	0242230557				
		2006-2009	FR8DII33X	0242230534										
		2006-2006							FGR7DQP+	0242236562				
	V8 4.4L	2007-2009					FR8DPP33X	0242230579	FR8DPP30X	0242230557				
		2006-2009	FR8DII33X	0242230534										
		2006-2006							FGR7DQP+	0242236562				
V8 5.0L	2010-2017	VR7MII33U	0242135569											

LINCOLN

Aviator	V8 4.6L	2003-2005	HR7KII33V	0242236603			HR7DPP33Y	0242236628	HR7DPP30Y	0242236613				
Continental	V6 3.0L	2018-2019	HR7NII332S	0242236675										
		1998-1999					HR7DPP33Y	0242236628	HR7DPP30Y	0242236613				
	V8 4.6L	1997-1999	HR7KII33V	0242236603										
		1997-1997					HR7DPP33V	0242236625	HR7DPP30V	0242236658				
LS	V6 3.0L	2004-2005	HR7DII33V	0242236594			HR7DPP33V	0242236625	HR7DPP30V	0242236658				
		2000-2006	FR7KII33X	0242236599			FR7DPP33X	0242236631	FR7DPP30X	0242236616				
	V8 3.9L	2000-2002									FR78X	0242232502		
Mark LT	V8 5.0L	2011-2014	HR7NII33X	0242236591			HR7MPP33X	0242236629	HR7MPP30X	0242236617				
Mark VIII	V8 4.6L	1996-1996	HR7KII33V	0242236603										
		1995-1996					HR7DPP33V	0242236625	HR7DPP30V	0242236658				
		1995-1995	HR7DII33V	0242236594									HR8DCX+	0242229775
MKC	L4 2.0L	2018-2019				HR7MII30T	0242236678							
	L4 2.3L	2015-2019				HR7MII30T	0242236678							
MKS	V6 3.7L	2009-2011	HR7NII33X	0242236591			HR7MPP33X	0242236629	HR7NPP30V	0242236672				
MKX	V6 2.7L	2016-2018	HR7NII332S	0242236675										
	V6 3.5L	2007-2010	HR7NII33X	0242236591			HR7MPP33X	0242236629	HR7NPP30V	0242236672				

Marca / Modelo	Motor	Años	Doble Iridio		Iridio		Doble Platino		Platino		Super 4		Níquel	
			Fórmula	Nº. de Parte	Fórmula	Nº. de Parte	Fórmula	Nº. de Parte	Fórmula	Nº. de Parte	Fórmula	Nº. de Parte	Fórmula	Nº. de Parte
MXK	V6 3.7L	2011-2015							HR7NPP30V	0242236672				
MKZ	L4 2.0L	2018-2019	HR8MII33V	0242230612										
		2013-2019			HR7MII30T	0242236678								
	V6 3.0L	2018-2019	HR7NII332S	0242236675										
	V6 3.5L	2007-2012	HR7NII33X	0242236591			HR7MPP33X	0242236629	HR7NPP30V	0242236672				
Nautilus	V6 2.7L	2013-2016							HR7NPP30V	0242236672				
		2019-2019	HR7NII332S	0242236675										
Navigator	V8 5.4L	2008-2011	AR7TII330U	0242135565										
		2001-2014	HR7DII33V	0242236594										
		2001-2004					HR7DPP33V	0242236625	HR7DPP30V	0242236658				
		1998-2000	HR7KII33V	0242236603			HR7DPP33Y	0242236628	HR7DPP30Y	0242236613				
Town Car	V8 4.6L	1995-1997	HR7KII33V	0242236603										
		1991-2007	HR7DII33V	0242236594			HR7DPP33V	0242236625	HR7DPP30V	0242236658				
		1991-1994											HR8DCX+	0242229775
Zephyr	V6 3.0L	2006-2006	HR7KII33V	0242236603			HR7DPP33Y	0242236628	HR7DPP30Y	0242236613				

MAYBACH

57	V12 5.5L	2003-2006			FR7KI332S	0242236571								
	V12 6.0L	2006-2009			FR7KI332S	0242236571								
62	V12 5.5L	2003-2009			FR7KI332S	0242236571								

MAZDA

2	L4 1.5L	2015-2018	VR7NII33X	0242135529											
		2012-2014	FR7DII33X	0242236596			FR7DPP33X	0242236631	FR7DPP30X	0242236616					
3	L4 2.0L	2015-2018	VR7NII33X	0242135529											
		2012-2014	VR6NII35T*	0242140536*											
		2006-2012	HR8MII33V	0242230612					HR8NPP302X	0242230573					
	L4 2.3L	2006-2009	HR8MII33V	0242230612					HR8NPP302X	0242230573					
	L4 2.3L Turbo	2008-2008	HR7NII332S	0242236675											
		2015-2020	VR7NII33X	0242135529											
2014-2014		VR6NII35T*	0242140536*												
L4 2.5L	2010-2013	HR8MII33V	0242230612					HR8NPP302X	0242230573						









M

Marca / Modelo	Motor	Años	Doble Iridio		Iridio		Doble Platino		Platino		Super 4		Níquel	
			Fórmula	Nº. de Parte	Fórmula	Nº. de Parte	Fórmula	Nº. de Parte	Fórmula	Nº. de Parte	Fórmula	Nº. de Parte	Fórmula	Nº. de Parte
B200	L4 2.0L	2011-2011	FR8DII33X	0242230534			FR8DPP33X	0242230579	FR8DPP30X	0242230557				
		2006-2011											FQR8DE	0242229724
		2006-2009					FR7KPP33U+	0242236544						
C180	L4 1.6L	2013-2019	VA6SIP80	0241140537										
	L4 1.8L	2011-2012					YR6NPP332	0242140512						
C200	L4 1.5L	2019-2019	VA6SIP80	0241140537										
	L4 1.8L	2011-2014					YR6NPP332	0242140512						
	L4 1.8L Turbo	2010-2010					YR6NPP332	0242140512						
	L4 2.0L	2001-2002	FR7KII33X	0242236599	FR6KI332S	0242240653	FR7KPP33U+	0242236544	FR7DPP30X	0242236616				
C220	L4 2.2L	1995-1997							FR8DPP30T	0242230572			F8DC4	0241229713
C230	L4 1.8L	2004-2005					FR6MPP332	0242240619						
		1999-2000							FR7DPP30T	0242236618			FR7KTC	0242235766
		1997-1997							FR8DPP30T	0242230572			F8DC4	0241229713
	1996-1998											FR6DC+	0242240593	
	L4 2.3L Supercargado	1997-1997										FR6DC+	0242240593	
C240	V6 2.6L	2001-2002	FR8DII33X	0242230534			FR8DPP33+	0242230500	FR8DPP30X	0242230557				
C250	L4 1.8L	2012-2015					YR6NPP332	0242140512						
C280	L6 2.8L	1995-1997							FR8DPP30T	0242230572			F8DC4	0241229713
		1999-2000	FR8DII33X	0242230534			FR8DPP33+	0242230500	FR8DPP30X	0242230557				
	V6 3.0L	2009-2009					YR6NPP332	0242140512						
	V6 3.0L	2006-2008					YR7MPP33	0242135509						
C300	L4 2.0L	2019-2020	VA6SIP80	0241140537										
	V6 3.0L	2010-2011					YR7MPP33	0242135509						
C32 AMG	V6 3.2L	2002-2004	FR7KII33X	0242236599			FR7KPP33U+	0242236544	FR7DPP30X	0242236616				
C320	V6 3.2L	2001-2005	FR8DII33X	0242230534			FR8DPP33+	0242230500	FR8DPP30X	0242230557				
C350	V6 3.5L	2013-2014	ZR6SII3320	0242140521										
		2006-2009					YR7MPP33	0242135509						
C36 AMG	L6 3.6L	1996-1997							FR8DPP30T	0242230572			F8DC4	0241229713
C43 AMG	V6 3.0L	2018-2019	V6SII3328	0241140522										
		2017-2017	VA6SIP80	0241140537										
	V8 4.3L	1998-2000	FR8DII33X	0242230534			FR8DPP33+	0242230500	FR8DPP30X	0242230557				
C450 AMG	V6 3.0L	2016-2016	VA6SIP80	0241140537										



M



Marca / Modelo	Motor	Años	 Doble Iridio		 Iridio		 Doble Platino		 Platino		 Super 4		 Níquel	
			Fórmula	Nº. de Parte	Fórmula	Nº. de Parte	Fórmula	Nº. de Parte	Fórmula	Nº. de Parte	Fórmula	Nº. de Parte	Fórmula	Nº. de Parte
C55 AMG	V8 5.4L	2005-2006	FR7KII33X	0242236599			FR7KPP33U+	0242236544	FR7DPP30X	0242236616				
C63 AMG	V8 4.0L	2018-2019	VA6SIP80	0241140537										
		2016-2017	V6SII3328	0241140522										
C63 AMG S	V8 4.0L	2018-2019	VA6SIP80	0241140537										
		2016-2017	V6SII3328	0241140522										
CL500	V8 5.0L	1997-2006	FR8DII33X	0242230534			FR8DPP33+	0242230500	FR8DPP30X	0242230557				
		1997-1998											F8DC4	0241229713
		2007-2012					YR7MPP33	0242135509						
CL55 AMG	V8 5.5L	2007-2008					YR6NPP332	0242140512						
		2003-2004					FR6MPP332	0242240619						
CL600	V12 5.5L	2003-2013	FR7KII332S	0242236668	FR7KI332S	0242236571								
	V12 5.8L	2001-2002	FR8DII33X	0242230534			FR7KPP33U+	0242236544	FR8DPP30X	0242230557				
	V12 6.0L	1998-1999	FR8DII33X	0242230534			FR7KPP33U+	0242236544					FR8DC+	0242229659
CL65 AMG	V12 6.0L	2013-2013	FR7KII332S	0242236668										
		2005-2013			FR7KI332S	0242236571	FR7KPP33U+	0242236544						
CLA45 AMG	L4 2.0L	2014-2019	VA6SIP80	0241140537										
CLK280	V6 3.0L	2007-2009					YR7MPP33	0242135509						
CLK320	V6 3.2L	1998-2005	FR8DII33X	0242230534			FR8DPP33+	0242230500	FR8DPP30X	0242230557				
CLK350	V6 3.5L	2006-2009					YR7MPP33	0242135509						
CLK430	V8 4.3L	1999-2003	FR8DII33X	0242230534			FR8DPP33+	0242230500	FR8DPP30X	0242230557				
CLK500	V8 5.0L	2003-2006	FR8DII33X	0242230534			FR8DPP33+	0242230500	FR8DPP30X	0242230557				
	V8 5.5L	2007-2009					YR6NPP332	0242140512						
CLK55 AMG	V8 5.4L	2003-2004	FR7KII33X	0242236599			FR7KPP33U+	0242236544	FR7DPP30X	0242236616				
CLS350	V6 3.5L	2010-2014	ZR6SII3320	0242140521										
	V6 3.5L	2007-2009					YR7MPP33	0242135509						
CLS500	V8 5.0L	2005-2006					FR8DPP33+	0242230500						
		2007-2011					YR6NPP332	0242140512						
CLS55 AMG	V8 5.4L	2006-2006					FR6MPP332	0242240619						
CLS63 AMG	V8 5.5L	2012-2014	ZR6SII3320	0242140521										
CLS63 AMG S	V8 5.5L	2017-2018	ZR6SII3320	0242140521										
E200	L4 1.8L	2012-2013					YR6NPP332	0242140512						
E250	L4 1.8L	2011-2013					YR6NPP332	0242140512						
E280	V6 2.8L	1999-1999					FR8DPP33+	0242230500						

Marca / Modelo	Motor	Años	Doble Iridio		Iridio		Doble Platino		Platino		Super 4		Níquel	
			Fórmula	Nº. de Parte	Fórmula	Nº. de Parte	Fórmula	Nº. de Parte	Fórmula	Nº. de Parte	Fórmula	Nº. de Parte	Fórmula	Nº. de Parte
E280	V6 3.0L	2007-2009					YR7MPP33	0242135509						
E300	V6 3.0L	2010-2011					YR7MPP33	0242135509						
E320	L6 3.2L	1996-1996							FR8DPP30T	0242230572			F8DC4	0241229713
	V6 3.2L	1998-2005	FR8DII33X	0242230534			FR8DPP33+	0242230500	FR8DPP30X	0242230557				
E350	V6 3.5L	2013-2013	ZR6SII3320	0242140521										
		2006-2011					YR7MPP33	0242135509						
E400	V6 3.0L	2015-2017	VA6SIP80	0241140537										
E420	V8 4.2L	1994-1998							FR8DPP30T	0242230572			F8DC4	0241229713
E430	V8 4.3L	1998-2001	FR8DII33X	0242230534			FR8DPP33+	0242230500	FR8DPP30X	0242230557				
E450	V6 3.0L	2019-2019	V6SII3328	0241140522										
E500	V8 5.0L	2003-2006	FR8DII33X	0242230534			FR8DPP33+	0242230500	FR8DPP30X	0242230557				
	V8 5.5L	2016-2016	ZR6SII3320	0242140521										
E55 AMG	V8 5.4L	2003-2006					FR6MPP332	0242240619						
		2002-2006	FR8DII33X	0242230534					FR8DPP30X	0242230557				
	2002-2002					FR8DPP33+	0242230500							
	V8 5.5L	1998-2001	FR8DII33X	0242230534			FR8DPP33+	0242230500	FR8DPP30X	0242230557				
E63 AMG	V8 4.0L	2020-2020	VA6SIP80	0241140537										
E63 AMG S	V8 4.0L	2019-2019	VA6SIP80	0241140537										
G500	V8 5.0L	2002-2008	FR8DII33X	0242230534					FR8DPP30X	0242230557				
		1999-2008					FR8DPP33+	0242230500						
	V8 5.5L	2009-2014					YR7MPP33	0242135509						
G55 AMG	V8 5.4L	2009-2011					YR6NPP332	0242140512						
G55 AMG	V8 5.4L	2009-2011					FR6MPP332	0242240619						
G63 AMG	V8 4.0L	2019-2019	VA6SIP80	0241140537										
G65 AMG	V12 6.0L	2016-2018	FR7KII332S	0242236668										
		2014-2018			FR7KI332S	0242236571								
GL450	V8 4.7L	2007-2009					YR6NPP332	0242140512						
GL500	V8 5.5L	2008-2012					YR7MPP33	0242135509						
		2008-2012					YR6NPP332	0242140512						
GLA180	L4 1.6L	2016-2018	VA6SIP80	0241140537										
GLA200	L4 1.6L	2014-2019	VA6SIP80	0241140537										
	L4 2.0L	2014-2015	VA6SIP80	0241140537										



M



Marca / Modelo	Motor	Años	Doble Iridio		Iridio		Doble Platino		Platino		Super 4		Níquel	
			Fórmula	Nº. de Parte	Fórmula	Nº. de Parte	Fórmula	Nº. de Parte	Fórmula	Nº. de Parte	Fórmula	Nº. de Parte	Fórmula	Nº. de Parte
GLA45 AMG	L4 2.0L	2018-2019	V6SII3328	0241140522										
GLC43 AMG	V6 3.0L	2020-2020	V6SII3328	0241140522										
GLE400	V6 3.0L	2019-2019	V6SII3328	0241140522										
		2017-2017	VA6SIP80	0241140537										
GLE450 AMG	V6 3.0L	2016-2016	VA6SIP80	0241140537										
GLK280	V6 3.0L	2009-2009					YR7MPP33	0242135509						
GLK300	V6 3.0L	2010-2012					YR7MPP33	0242135509						
GLK350	V6 3.5L	2013-2015					YR7MPP33	0242135509						
Maybach S600	V12 6.0L	2016-2017	FR7KII332S	0242236668	FR7KI332S	0242236571								
Maybach S650	V12 6.0L	2018-2019	FR7KII332S	0242236668	FR7KI332S	0242236571								
ML320	V6 3.2L	1998-2002	FR8DII33X	0242230534			FR8DPP33+	0242230500	FR8DPP30X	0242230557				
ML350	V6 3.5L	2012-2015	FR8KII33X	0242230528			FR8DPP33X	0242230579	FR8DPP30X	0242230557				
		2006-2011					YR7MPP33	0242135509						
	V6 3.7L	2003-2005	FR8DII33X	0242230534			FR8DPP33+	0242230500	FR8DPP30X	0242230557				
ML430	V8 4.3L	1999-2001	FR8DII33X	0242230534			FR8DPP33+	0242230500	FR8DPP30X	0242230557				
ML500	V8 4.7L	2012-2015	FR8KII33X	0242230528			FR8DPP33X	0242230579	FR8DPP30X	0242230557				
	V8 5.0L	2002-2007	FR8DII33X	0242230534			FR8DPP33+	0242230500	FR8DPP30X	0242230557				
	V8 5.5L	2008-2011					YR7MPP33	0242135509						
		2008-2011					YR6NPP332	0242140512						
ML55 AMG	V8 5.4L	2002-2003	FR8DII33X	0242230534			FR8DPP33+	0242230500	FR8DPP30X	0242230557				
	V8 5.5L	2001-2001	FR8DII33X	0242230534			FR8DPP33+	0242230500	FR8DPP30X	0242230557				
R350	V6 3.5L	2008-2012					YR7MPP33	0242135509						
R500	V8 5.0L	2006-2007	FR8DII33X	0242230534			FR8DPP33+	0242230500	FR8DPP30X	0242230557				
S420	V8 4.2L	1998-1998	FR8DII33X	0242230534			FR8DPP33+	0242230500	FR8DPP30X	0242230557				
		1996-1997							FR8DPP30T	0242230572			F8DC4	0241229713
S430	V8 4.3L	2000-2005	FR8DII33X	0242230534					FR8DPP30X	0242230557				
		1999-2005						FR8DPP33+	0242230500					
S500	V8 4.7L	2017-2017	ZR6SII3320	0242140521										
	V8 5.0L	2000-2006	FR8DII33X	0242230534					FR8DPP30X	0242230557				
		1998-2006						FR8DPP33+	0242230500					
		1996-1997								FR8DPP30T	0242230572			F8DC4
	V8 5.5L	2007-2011						YR7MPP33	0242135509					
2007-2011							YR6NPP332	0242140512						

Marca / Modelo	Motor	Años	Doble Iridio		Iridio		Doble Platino		Platino		Super 4		Níquel	
			Fórmula	Nº. de Parte	Fórmula	Nº. de Parte	Fórmula	Nº. de Parte	Fórmula	Nº. de Parte	Fórmula	Nº. de Parte	Fórmula	Nº. de Parte
S500L	V8 4.7L	2017-2017	ZR6SII3320	0242140521										
S55 AMG	V8 5.4L	2003-2005					FR6MPP332	0242240619						
S600	V12 5.5L	2003-2009	FR7KII332S	0242236668	FR7KI332S	0242236571	FR7KPP33U+	0242236544						
	V12 5.8L	2001-2002	FR8DII33X	0242230534			FR7KPP33U+	0242236544						
	V12 6.0L	2015-2015			FR7KI332S	0242236571								
		1996-1998						FR8DPP33+	0242230500					
	1996-1997								FR8DPP30T	0242230572			F8DC4	0241229713
S600L	V12 6.0L	1995-1995					FR8DPP33+	0242230500	FR8DPP30T	0242230572			F8DC4	0241229713
S63 AMG	V8 4.0L	2019-2019	VA6SIP80	0241140537										
S63L AMG	V8 5.5L	2017-2017	ZR6SII3320	0242140521										
S65 AMG	V12 6.0L	2007-2009					FR7KPP33U+	0242236544						
		2005-2019	FR7KII332S	0242236668	FR7KI332S	0242236571								
S65L AMG	V12 6.0L	2017-2017	FR7KII332S	0242236668	FR7KI332S	0242236571								
SL320	L6 3.2L	1996-1997							FR8DPP30T	0242230572			F8DC4	0241229713
SL500	V8 4.7L	2015-2019	ZR6SII3320	0242140521										
		2013-2014	FR8KII33X	0242230528			FR8DPP33X	0242230579	FR8DPP30X	0242230557				
	V8 5.0L	2004-2006	FR8DII33X	0242230534					FR8DPP30X	0242230557				
		1998-2006					FR8DPP33+	0242230500						
		1996-1998							FR8DPP30T	0242230572			F8DC4	0241229713
	V8 5.5L	2007-2012					YR7MPP33	0242135509						
2007-2012						YR6NPP332	0242140512							
SL55 AMG	V8 5.4L	2003-2007					FR6MPP332	0242240619						
SL60 AMG	V8 6.0L	1998-1998					FR8DPP33+	0242230500						
		1997-1997							FR8DPP30T	0242230572			F8DC4	0241229713
SL600	V12 5.5L	2003-2012	FR7KII332S	0242236668	FR7KI332S	0242236571	FR7KPP33U+	0242236544						
		1998-2002					FR8DPP33+	0242230500						
	V12 6.0L	1998-1998	FR8DII33X	0242230534					FR8DPP30X	0242230557				
		1996-2002							FR8DPP30T	0242230572			F8DC4	0241229713
SL65 AMG	V12 6.0L	2005-2017	FR7KII332S	0242236668	FR7KI332S	0242236571	FR7KPP33U+	0242236544						
SLC43 AMG	V6 3.0L	2017-2019	VA6SIP80	0241140537										
SLK200	L4 1.8L	2012-2015					YR6NPP332	0242140512						
		2008-2011					YR7MPP33	0242135509						
	L4 2.0L	2003-2004	FR7KII33X	0242236599			FR7KPP33U+	0242236544	FR7DPP30X	0242236616				



M

Marca / Modelo	Motor	Años	Doble Iridio		Iridio		Doble Platino		Platino		Super 4		Níquel	
			Fórmula	Nº. de Parte	Fórmula	Nº. de Parte	Fórmula	Nº. de Parte	Fórmula	Nº. de Parte	Fórmula	Nº. de Parte	Fórmula	Nº. de Parte
SLK230	L4 2.3L	2001-2004							FR7DPP30X	0242236616				
		2000-2004	FR7KII33X	0242236599			FR7KPP33U+	0242236544						
		1997-2000							FR7DPP30T	0242236618			FR7KTC	0242235766
SLK32 AMG	V6 3.2L	2002-2004	FR7KII33X	0242236599			FR7KPP33U+	0242236544	FR7DPP30X	0242236616				
SLK320	V6 3.2L	2001-2004	FR8DII33X	0242230534			FR8DPP33+	0242230500	FR8DPP30X	0242230507				
SLK350	V6 3.5L	2005-2013					YR7MPP33	0242135509						
SLK55 AMG	V8 5.5L	2013-2016					FR7DPP33X	0242236631						
		2006-2011					FR7KPP33U+	0242236544						
		2005-2016	FR7KII33X	0242236599					FR7DPP30X	0242236616				
		2005-2005					FR8DPP33+	0242230500						
SLR McLaren	V8 5.4L	2007-2008					FR6MPP332	0242240619						

MERCURY

Mariner	V6 3.0L	2009-2011	HR8KII33V	0242230535										
		2009-2009					HR8DPP33V	0242230583	HR8DPP30V	0242230561				
		2008-2008	HR7DII33V	0242236594										
		2005-2008					HR7DPP33V	0242236625	HR7DPP30V	0242236658				
		2005-2007	HR7KII33V	0242236603										
Milan	V6 3.0L	2007-2008	HR7KII33V	0242236603			HR7DPP33Y	0242236628	HR7DPP30Y	0242236613				
Montego	V6 3.0L	2005-2007	HR7KII33V	0242236603			HR7DPP33Y	0242236628	HR7DPP30Y	0242236613				
Sable	V6 3.0L	2002-2004	HR7KII33V	0242236603			HR7DPP33V	0242236625	HR7DPP30V	0242236658				

MG

TF	L4 1.8L	2003-2005					FR7KPP33U+	0242236544						
ZR	L4 1.8L	2004-2005					FR7KPP33U+	0242236544						

MINI

Cooper	L3 1.5L	2014-2019					ZR5SPP3320	0242145555						
	L4 1.6L	2012-2016			ZR5SI332	0242145537								
		2010-2015							ZR6SPP302	0242140535				
		2009-2012			ZR7SI332S	0242135518								
		2007-2010			ZQR8SI302	0242129512								
		2005-2006											FR6DC+	0242240593

Marca / Modelo	Motor	Años	Doble Iridio		Iridio		Doble Platino		Platino		Super 4		Níquel	
			Fórmula	Nº. de Parte	Fórmula	Nº. de Parte	Fórmula	Nº. de Parte	Fórmula	Nº. de Parte	Fórmula	Nº. de Parte	Fórmula	Nº. de Parte
Cooper	L4 1.6L	2003-2008											FR7DC+	0242235666
		2002-2008							FGR7DQP+	0242236562				
		2002-2006									FR78X	0242232502		
	L4 1.6L Supercargado	2004-2005									FR78X	0242232502		
		2004-2004											FR7DC+	0242235666
	L4 1.6L Turbo	2012-2012			ZR5SI332	0242145537								
		2007-2012			ZR7SI332S	0242135518								
2007-2007								FGR7DQP+	0242236562					
L4 2.0L	2014-2019					ZR5SPP3320	0242145555							
Cooper Clubman	L3 1.5L	2018-2019					ZR5SPP3320	0242145555						
	L4 2.0L	2017-2019					ZR5SPP3320	0242145555						
Cooper Countryman	L3 1.5L	2018-2019					ZR5SPP3320	0242145555						
	L4 1.6L	2011-2015			ZR5SI332	0242145537								
	L4 2.0L	2018-2019					ZR5SPP3320	0242145555						



MITSUBISHI

ASX	L4 2.0L	2013-2015			FR6KI332S	0242240653								
Eclipse	V6 3.0L	2004-2005			FR6KI332S	0242240653			FR8DPP30T	0242230572				
		2003-2005					FR8DPP33X	0242230579						
		2003-2003	FR8KII33X	0242230528			FR7KPP33+	0242236564	FR8DPP30X	0242230557				
	V6 3.8L	2008-2012											FR8DCX+	0242229660
		2006-2012			FR6KI332S	0242240653								
Endeavor	V6 3.8L	2009-2011										FR8DCX+	0242229660	
		2004-2011	FR7KII33X	0242236599	FR6KI332S	0242240653	FR7DPP33X	0242236631	FR7DPP30T	0242236618				
Galant	L4 2.4L	2004-2009			FR7SI332	0242236655								
	V6 3.0L	2003-2003	FR8KII33X	0242230528			FR8DPP33X	0242230579	FR8DPP30X	0242230557				
	V6 3.8L	2004-2009	FR7KII33X	0242236599	FR6KI332S	0242240653	FR7DPP33X	0242236631	FR7DPP30T	0242236618				
L200	L4 2.4L	2010-2016			FR6KI332S	0242240653			FR7DPP30X	0242236616			FR7DCX+	0242235667
	L4 2.4L	2008-2021									FR78X	0242232502	FR8DCX+	0242229660
Lancer	L4 2.0L	2011-2016	FR7DII35X*	0242236642*										
		2008-2016			FR6KI332S	0242240653								
		2006-2006	FR6NII332S	0242240715										
		2005-2007									FR78X	0242232502		



Marca / Modelo	Motor	Años	Doble Iridio		Iridio		Doble Platino		Platino		Super 4		Níquel		
			Fórmula	Nº. de Parte	Fórmula	Nº. de Parte	Fórmula	Nº. de Parte	Fórmula	Nº. de Parte	Fórmula	Nº. de Parte	Fórmula	Nº. de Parte	
Lancer	L4 2.0L	2004-2007	FR8DII33X	0242230534			FR8DPP33X	0242230579	FR8DPP30X	0242230557			FR8DCX+	0242229660	
		2004-2007	FR7DII33X	0242236596			FR7DPP33X	0242236631	FR7DPP30X	0242236616			FR7DCX+	0242235667	
		2004-2004			WR7KI33S	0242236576									
	L4 2.4L	2011-2016	FR7DII35X*	0242236642*											
		2005-2006	FR7NII33X	0242236593	FR7SI332	0242236655	FR7MPP33X	0242236630	FR7NPP30X	0242236619					
Mirage	L3 1.2L	2015-2020			FR7SI30	0242235769									
Mirage G4	L3 1.2L	2019-2020			FR7SI30	0242235769									
Montero	V6 3.8L	2012-2019			FR6KI332S	0242240653									
		2008-2011					FR7KPP33+	0242236564							
		2006-2006					FR7DPP33X	0242236631							
		2003-2006	FR7KII33X	0242236599					FR7DPP30T	0242236618					
Montero Sport	V6 3.0L	2012-2015	FR7DII33X	0242236596			FR7DPP33X	0242236631	FR7DPP30X	0242236616					
	V6 3.5L	2009-2011											FR8DCX+	0242229660	
		2003-2004	FR7DII33X	0242236596											
Outlander	L4 2.4L	2014-2020	YR8NII35U*	0242129526*											
		2011-2013	FR8DII33X/ FR7DII35X*	0242230534/ 0242236642*											
		2010-2013											FR8DCX+	0242229660	
		2008-2013							FR8DPP30T	0242230572					
	2004-2006			FR7SI332	0242236655										
Space Star	V6 3.0L	2007-2013	YR7NII33S	0242135533											
	L4 1.8L	2003-2004	FR8DII33X	0242230534			FR8DPP33X	0242230579	FR8DPP30X	0242230557	FR78X	0242232502	FR8DCX+	0242229660	

NISSAN

240SX	L4 2.4L	1998-1998	FR7KII33X	0242236599										
		1998-1998	FR8KII33X	0242230528										
		1993-1998					FR8DPP33X	0242230579	FR8DPP30X	0242230557				
		1993-1998					FR7DPP33X	0242236631	FR7DPP30X	0242236616				
		1993-1993	FR8DII33X	0242230534									FR8DCX+	0242229660
		1993-1993	FR7DII33X	0242236596									FR7DCX+	0242235667
300ZX	V6 3.0L	1991-1996	FR8KII33X	0242230528			FR8DPP33X	0242230579	FR8DPP30X	0242230557				
		1991-1996	FR7KII33X	0242236599			FR7DPP33X	0242236631	FR7DPP30X	0242236616				

Marca / Modelo	Motor	Años	Doble Iridio		Iridio		Doble Platino		Platino		Super 4		Níquel		
			Fórmula	Nº. de Parte	Fórmula	Nº. de Parte	Fórmula	Nº. de Parte	Fórmula	Nº. de Parte	Fórmula	Nº. de Parte	Fórmula	Nº. de Parte	
350Z	V6 3.5L	2007-2008	VR6NII35U*	0242140550*											
		2003-2006	FR7NII33X	0242236593			FR7MPP33X	0242236630	FR7NPP30X	0242236619	FR78NX	0242232515			
		2003-2006	FR8MII33X	0242230533			FR8MPP33X	0242230584	FR8MPP30X	0242230562					
370Z	V6 3.7L	2009-2020	VR6NII35U*	0242140550*											
Almera	L4 1.8L	2002-2005									FR78NX	0242232515	FR8ME+	F000KE0P24	
		2001-2005	FR7DII33X	0242236596			FR7DPP33X	0242236631	FR7DPP30X	0242236616					
		2001-2001			FR6KI332S	0242240653					FR78X	0242232502	FR7DCX+	0242235667	
Altima	L4 2.4L	2000-2001	FR7KII33X	0242236599											
		1998-2001	FR8KII33X	0242230528											
		1996-2001					FR8DPP33X	0242230579	FR8DPP30X	0242230557			FR8DCX+	0242229660	
		1996-2001					FR7DPP33X	0242236631	FR7DPP30X	0242236616					
		1996-1997	FR7DII33X	0242236596							FR78X	0242232502	FR7DCX+	0242235667	
		1996-1997	FR8DII33X	0242230534											
	L4 2.5L	2013-2018	VR7TII35U*	0242135531*											
		2007-2018												FR8ME+	F000KE0P24
		2007-2012	VR8NII35U*	0242129514*			VR8SPP33X	0242129516							
		2002-2006	FR8MII33X	0242230533			FR8MPP33X	0242230584	FR8MPP30X	0242230562					
		2002-2006	FR7NII33X	0242236593			FR7MPP33X	0242236630	FR7NPP30X	0242236619					
V6 3.5L	2007-2018	VR6NII35U*	0242140550*												
	2002-2006	FR7NII33X	0242236593			FR7MPP33X	0242236630	FR7NPP30X	0242236619	FR78NX	0242232515				
	2002-2006	FR8MII33X	0242230533			FR8MPP33X	0242230584	FR8MPP30X	0242230562						
Aprio	L4 1.6L	2009-2010											FR7DC+	0242235666	
		2008-2010						FR7DPP30X	0242236616				HR8DCX+	0242229775	
Armada	V8 5.6L	2007-2015	FR8NII35U*	0242230554*											
		2005-2015					FR8MPP33X	0242230584	FR8MPP30X	0242230562					
		2005-2006	FR7NII33X	0242236593			FR7MPP33X	0242236630	FR7NPP30X	0242236619					
		2005-2006	FR8MII33X	0242230533											
Frontier	L4 2.4L	2011-2015	FR7DII33X	0242236596									FR7DCX+	0242235667	
		2006-2008					VR8SPP33X	0242129516							
		2001-2015					FR7DPP33X	0242236631	FR7DPP30X	0242236616					
		2001-2004	FR7KII33X	0242236599			FR8DPP33X	0242230579	FR8DPP30X	0242230557					
		2001-2004	FR8KII33X	0242230528											
	V6 3.3L	2001-2004	FR8KII33X	0242230528			FR8DPP33X	0242230579	FR8DPP30X	0242230557					



N



Marca / Modelo	Motor	Años	Doble Iridio		Iridio		Doble Platino		Platino		Super 4		Níquel		
			Fórmula	Nº. de Parte	Fórmula	Nº. de Parte	Fórmula	Nº. de Parte	Fórmula	Nº. de Parte	Fórmula	Nº. de Parte	Fórmula	Nº. de Parte	
Frontier	V6 3.3L	2001-2001	FR7KII33X	0242236599			FR7DPP33X	0242236631	FR7DPP30X	0242236616					
		2001-2001	FR6KII33X	0242240669			FR6KPP33X+	0242240649							
	V6 4.0L	2019-2019	VR8SII33X	0242129529			VR8SPP33X	0242129516							
		2008-2019	FR8NII35U*	0242230554*											
Ichi Van	L4 1.8L	1987-1992											W8DC	0241229715	
		1987-1992											WR8DC+	0242229656	
	L4 2.4L	1992-1994							FR8HPP30X	0242230567					
Juke	L4 1.6L	2012-2017	VR6NII35T*	0242140536*											
Lucino	L4 1.6L	1997-2000									FR78X	0242232502			
		1996-2000	FR7DII33X	0242236596			FR7DPP33X	0242236631	FR7DPP30X	0242236616			FR8DCX+	0242229660	
		1996-2000											FR7DCX+	0242235667	
	L4 2.0L	1999-2000												FR7KC+	0242236561
		1996-2000			FR6KI332S	0242240653					FR78X	0242232502			
		1996-1998	FR8KII33X	0242230528			FR8DPP33X	0242230579	FR8DPP30X	0242230557			FR8DC+	0242229659	
		1996-1998							FR8DPP30T	0242230572			FR7DC+	0242235666	
		1996-1998	FR7KII33X	0242236599			FR7DPP33X	0242236631	FR7DPP30T	0242236618			FR5DC	0242245536	
1996-1998							FR7DPP30X	0242236616							
March	L4 1.6L	2012-2019			VR8SII30X	0242129522									
Maxima	V6 3.0L	1998-2001					FR6KPP33X+	0242240649							
		1993-2001	FR8KII33X	0242230528											
		1993-1997	FR7KII33X	0242236599											
		1991-2001							FR8DPP30X	0242230557					
		1991-1997					FR8DPP33X	0242230579	FR7DPP30X	0242236616					
		1991-1997					FR7DPP33X	0242236631							
		1991-1993									FR78X	0242232502			
		1991-1992	FR8DII33X	0242230534									FR8DCX+	0242229660	
	1991-1992	FR7DII33X	0242236596									FR7DCX+	0242235667		
	V6 3.5L	2009-2018	VR6NII35U*	0242140550*											
		2007-2008	FR8NII35U*	0242230554*											
		2006-2006	FR7NII35U*	0242236605*											
		2002-2007					FR8MPP33X	0242230584							
2002-2006		FR8MII33X	0242230533					FR8MPP30X	0242230562						
2002-2005	FR7NII33X	0242236593					FR7MPP33X	0242236630	FR7NPP30X	0242236619					

Marca / Modelo	Motor	Años	Doble Iridio		Iridio		Doble Platino		Platino		Super 4		Níquel	
			Fórmula	Nº. de Parte	Fórmula	Nº. de Parte	Fórmula	Nº. de Parte	Fórmula	Nº. de Parte	Fórmula	Nº. de Parte	Fórmula	Nº. de Parte
Micra	L4 1.4L	2005-2007							FR8NPP30W	0242230602	FR78NX	0242232515		
Murano	V6 3.5L	2009-2020	VR6NII35U*	0242140550*										
		2004-2008	FR8MII33X	0242230533			FR8MPP33X	0242230584	FR8MPP30X	0242230562				
Note	L4 1.6L	2014-2019	VR8SII33X	0242129529	VR8SII30X	0242129522	VR8SPP33X	0242129516						
NP300	L4 2.4L	2009-2015	FR7DII33X	0242236596			FR7DPP33X	0242236631	FR7DPP30X	0242236616			FR7DCX+	0242235667
	L4 2.5L	2016-2018	VR7TII35U*	0242135531*										
NP300 Frontier	L4 2.5L	2016-2018	VR7TII35U*	0242135531*										
NV2500	V6 4.0L	2013-2015	FR8NII35U*	0242230554*										
	V8 5.6L	2013-2013	FR8NII35U*	0242230554*										
NV350 Urvan	L4 2.5L	2014-2020	VR8NII35U*	0242129514*										
Pathfinder	V6 3.3L	1999-2000	FR7KII33X	0242236599										
		1998-2000	FR8KII33X	0242230528										
		1997-2000					FR7DPP33X	0242236631	FR7DPP30X	0242236616	FR78X	0242232502		
		1997-2000					FR8DPP33X	0242230579	FR8DPP30X	0242230557				
		1997-1998	FR8DII33X	0242230534									FR8DCX+	0242229660
		1997-1997	FR7DII33X	0242236596									FR7DCX+	0242235667
	V6 3.5L	2013-2020	VR8NII35U*	0242129514*										
		2001-2004	FR8MII33X	0242230533			FR8MPP33X	0242230584	FR8MPP30X	0242230562				
		2001-2004	FR7NII33X	0242236593			FR7MPP33X	0242236630	FR7NPP30X	0242236619				
	V6 4.0L	2012-2012	FR7NII35U*	0242236605*										
		2008-2012	FR8NII35U*	0242230554*										
		2005-2012					FR8MPP33X	0242230584	FR8MPP30X	0242230562				
		2005-2007	FR7NII33X	0242236593			FR7MPP33X	0242236630	FR7NPP30X	0242236619				
Pathfinder Armada	V8 5.6L	2004-2004	FR8MII33X	0242230533			FR8MPP33X	0242230584	FR8MPP30X	0242230562				
		2004-2004	FR7NII33X	0242236593			FR7MPP33X	0242236630	FR7NPP30X	0242236619				
Pickup	L4 2.4L	2005-2010	FR8DII33X	0242230534			FR8DPP33X	0242230579	FR8DPP30X	0242230557				
		2005-2010	FR7DII33X	0242236596			FR7DPP33X	0242236631	FR7DPP30X	0242236616				
		1998-2010											FR8DCX+	0242229660
		1993-2004								FR8HPP30X	0242230567			
Platina	L4 1.6L	2002-2010	FR7DII33X	0242236596			FR7DPP33X	0242236631	FR7DPP30X	0242236616			FR7DCX+	0242235667



N

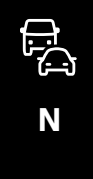

Marca / Modelo	Motor	Años	Doble Iridio		Iridio		Doble Platino		Platino		Super 4		Níquel		
			Fórmula	Nº. de Parte	Fórmula	Nº. de Parte	Fórmula	Nº. de Parte	Fórmula	Nº. de Parte	Fórmula	Nº. de Parte	Fórmula	Nº. de Parte	
Quest	V6 3.3L	1999-2002	FR8KII33X	0242230528			FR8DPP33X	0242230579	FR8DPP30X	0242230557					
		1999-2002	FR7KII33X	0242236599			FR7DPP33X	0242236631	FR7DPP30X	0242236616					
	V6 3.5L	2004-2009	FR8MII33X	0242230533			FR8MPP33X	0242230584	FR8MPP30X	0242230562					
		2004-2009	FR7NII33X	0242236593			FR7MPP33X	0242236630	FR7NPP30X	0242236619					
Rogue	L4 2.5L	2008-2014	VR8NII35U*	0242129514*			VR8SPP33X	0242129516							
Sentra	L4 1.6L	2018-2019	VR6NII35T*	0242140536*											
		1996-2000	FR7DII33X	0242236596			FR7DPP33X	0242236631	FR7DPP30X	0242236616			FR8DCX+	0242229660	
													FR7DCX+	0242235667	
	L4 1.8L	2013-2019	VR8SII33X/ VR8NII35U*	0242129529/ 0242129514*			VR8SPP33X	0242129516							
		2001-2006	FR8MII33X	0242230533			FR8MPP33X	0242230584	FR8MPP30X	0242230562					
			FR7NII33X	0242236593			FR7MPP33X	0242236630	FR7NPP30X	0242236619					
	L4 2.0L	2007-2012	VR8NII35U*	0242129514*			VR8SPP33X	0242129516							
		2007-2011	VR8SII33X	0242129529											
		1998-2001	FR7KII33X	0242236599											
		1998-2001	FR8KII33X	0242230528											
		1996-2001	FR6KII33X	0242240669			FR8DPP33X	0242230579	FR8DPP30X	0242230557			FR8DC+	0242229659	
		1996-2001					FR7DPP33X	0242236631	FR8DPP30T	0242230572				FR7DC+	0242235666
									FR6KPP33X+	0242240649	FR7DPP30X	0242236616			FR5DC
										FR7DPP30T	0242236618				
	L4 2.5L	2007-2012	VR8NII35U*	0242129514*			VR8SPP33X	0242129516							
		2002-2006	FR8MII33X	0242230533			FR8MPP33X	0242230584	FR8MPP30X	0242230562					
			FR7NII33X	0242236593			FR7MPP33X	0242236630	FR7NPP30X	0242236619					
Tiida	L4 1.6L	2016-2018	VR8SII33X	0242129529	VR8SII30X	0242129522									
		2014-2015	VR8NII35U*	0242129514*											
	L4 1.8L	2011-2013					VR7SPP33	0242135524							
2007-2018		VR8NII35U*	0242129514*												
Titan	V8 5.6L	2007-2015	FR8NII35U*	0242230554*											
		2004-2015	FR8MII33X	0242230533			FR8MPP33X	0242230584	FR8MPP30X	0242230562					
		2004-2006	FR7NII33X	0242236593			FR7MPP33X	0242236630	FR7NPP30X	0242236619					
Tsubame	L4 1.6L	1993-2004	FR8DII33X	0242230534			FR8DPP33X	0242230579	FR8DPP30X	0242230557			FR8DCX+	0242229660	

Marca / Modelo	Motor	Años	Doble Iridio		Iridio		Doble Platino		Platino		Super 4		Níquel	
			Fórmula	Nº. de Parte	Fórmula	Nº. de Parte	Fórmula	Nº. de Parte	Fórmula	Nº. de Parte	Fórmula	Nº. de Parte	Fórmula	Nº. de Parte
Tsuru	L4 1.5L	1984-1985							WR8DPP30W	0242230599	WR78X	0242232505	WR8DCX+	0242229687
	L4 1.6L	1993-2017	FR7DII33X	0242236596			FR7DPP33X	0242236631	FR7DPP30X	0242236616				
		1993-1996	FR8DII33X	0242230534			FR8DPP33X	0242230579	FR8DPP30X	0242230557			FR8DCX+	0242229660
		1993-1996											FR7DCX+	0242235667
		1989-2017									FR78X	0242232502		
		1986-1992							WR8DPP30W	0242230599			WR8DCX+	0242229687
		1986-1988									WR78X	0242232505		
L4 2.0L	1995-1996	FR7DII33X	0242236596			FR7DPP33X	0242236631	FR7DPP30X	0242236616			FR7DCX+	0242235667	
Urvan	L4 2.4L	2008-2008	VR8NII35U*	0242129514*										
		2000-2007			FR8DII33X	0242230534	FR8DPP33X	0242230579	FR8DPP30X	0242230557	FR78X	0242232502	FR8DCX+	0242229660
	L4 2.5L	2008-2013	VR8NII35U*	0242129514*										
Versa	L4 1.6L	2019-2019					VR8SPP33X	0242129516						
		2012-2019	VR8SII33X	0242129529	VR8SII30X	0242129522								
Xterra	V6 3.3L	2002-2002	FR6KII33X	0242240669			FR6KPP33X+	0242240649						
		2000-2004	FR8KII33X	0242230528			FR8DPP33X	0242230579	FR8DPP30X	0242230557				
		2000-2001	FR7KII33X	0242236599			FR7DPP33X	0242236631	FR7DPP30X	0242236616				
	V6 4.0L	2005-2007	FR8MII33X	0242230533			FR8MPP33X	0242230584	FR8MPP30X	0242230562				
		2005-2007	FR7NII33X	0242236593			FR7MPP33X	0242236630	FR7NPP30X	0242236619				
X-Trail	L4 2.5L	2014-2017	VR7TII35U*	0242135531*										
		2007-2013	VR8NII35U*	0242129514*										
		2005-2006									FR78NX	0242232515		
		2002-2007	FR8MII33X	0242230533			FR8MPP33X	0242230584	FR8MPP30X	0242230562				

OLDSMOBILE

Cutlass	V6 2.8L	1987-1989	HR9LII33X	0242225661			HR9LPP33X	0242225678	HR9LPP30X	0242225674				
	V6 3.1L	1996-1996					HR8DPP33Y	0242230581	HR8DPP30Y	0242230559			HR9DCY+	0242225623
		1994-1996	HR8KII33Y	0242230536										
		1987-1993	HR9LII33X	0242225661			HR9LPP33X	0242225678	HR9LPP30X	0242225674				
Silhouette	V6 3.1L	1991-1993						HR7BPP30X	0242236615					
	V6 3.8L	1994-1995	HR8KII33Y	0242230536			HR8DPP33Y	0242230581	HR8DPP30Y	0242230559			HR9DCY+	0242225623

Marca / Modelo	Motor	Años	Doble Iridio		Iridio		Doble Platino		Platino		Super 4		Níquel	
			Fórmula	Nº. de Parte	Fórmula	Nº. de Parte	Fórmula	Nº. de Parte	Fórmula	Nº. de Parte	Fórmula	Nº. de Parte	Fórmula	Nº. de Parte

PEUGEOT

206	L4 1.4L	2004-2009			FR6KI332S	0242240653					FR78X	0242232502	FR7DC+	0242235666	
		2000-2003						FR7DPP33X	0242236631	FR7DPP30T	0242236618				
	L4 1.6L	2002-2007								FR8NPP30W	0242230602			FR8SC+	0242229797
2001-2007											FR78NX	0242232515	FR8ME+	F000KE0P24	
207	L4 1.4L	2010-2011											FR6KDC+	0242240648	
	L4 1.6L	2012-2013			FR7NI33	0242236528									
		2010-2011			ZQR8SI302	0242129512			FR8NPP30W	0242230602	FR78NX	0242232515	FR8SC+	0242229797	
	L4 1.6L Turbo	2008-2013			ZR7SI332S	0242135518									
208	L3 1.2L	2010-2011			ZR7SI332S	0242135518									
	L4 1.6L	2019-2021			ZR6SI332	0242140559									
301	L4 1.6L	2014-2016			ZQR8SI302	0242129512									
		2013-2021							FR8NPP30W	0242230602	FR78NX	0242232515	FR8SC+	0242229797	
306	L4 1.6L	1997-1997									FR78X	0242232502	FR7DC+	0242235666	
	L4 1.8L	2001-2002							FR7DPP30T	0242236618	FR78X	0242232502	FR7DC+	0242235666	
	L4 2.0L	2001-2002							FR7DPP30T	0242236618	FR78X	0242232502	FR7DC+	0242235666	
307	L4 2.0L	2006-2010											FR8SC+	0242229797	
		2003-2010									FR78NX	0242232515			
		2003-2009								FR8NPP30W	0242230602				
		2003-2005												FR8ME+	F000KE0P24
308	L4 1.6L	2019-2020	ZR6SII3320	0242140521											
		2017-2017			ZR5SI332	0242145537									
		2009-2016			ZR7SI332S	0242135518									
406	V6 2.9L	2003-2005					FR8SPP332	0242229708							
	V6 3.0L	2001-2002					FR8SPP332	0242229708							
407	L4 2.2L	2006-2009							FR8NPP30W	0242230602	FR78NX	0242232515	FR8ME+	F000KE0P24	
	V6 2.9L	2007-2008	FR8KII33X	0242230528			FR8DPP33X	0242230579	FR8DPP30X	0242230557					
		2006-2006					FR8SPP332	0242229708							
508	L4 1.6L	2012-2017			ZR7SI332S	0242135518									
607	V6 2.9L	2002-2008					FR8SPP332	0242229708							
2008	L3 1.2L	2019-2021			ZR6SI332	0242140559									
	L4 1.6L	2014-2016			ZQR8SI302	0242129512									



Marca / Modelo	Motor	Años	Doble Iridio		Iridio		Doble Platino		Platino		Super 4		Níquel	
			Fórmula	Nº. de Parte	Fórmula	Nº. de Parte	Fórmula	Nº. de Parte	Fórmula	Nº. de Parte	Fórmula	Nº. de Parte	Fórmula	Nº. de Parte
3008	L4 1.6L	2011-2016			ZR7SI332S	0242135518								
207 Compact	L4 1.4L	2009-2011									FR78NX	0242232515	FR8ME+	F000KE0P24
	L4 1.6L	2010-2011			FR7NI33	0242236528								
		2009-2009			ZR7SI332S	0242135518								
208 GT	L4 1.6L	2014-2014			ZR7SI332S	0242135518								
Grand Raid	L4 1.6L	2008-2012									FR78NX	0242232515	FR8SC+	0242229797
Partner	L4 1.6L	2003-2012									FR78NX	0242232515	FR8SC+	0242229797
RCZ	L4 1.6L	2011-2016			ZR7SI332S	0242135518								

PONTIAC

Aztek	V6 3.4L	2002-2005	HR9KII33Y	0242225659			HR9DPP33Y	0242225677	HR9DPP30Y	0242225670				
	V6 3.4L	2001-2001	HR8KII33Y	0242230536			HR8DPP33Y	0242230581	HR8DPP30Y	0242230559				
Bonneville	V6 3.8L	1995-1999	HR9KII33Y	0242225659			HR9DPP33Y	0242225677	HR9DPP30Y	0242225670				
		1994-1995										HR9DCY+	0242225623	
		1994-1994	HR8KII33Y	0242230536			HR8DPP33Y	0242230581	HR8DPP30Y	0242230559				
Firebird	V8 5.7L	2000-2001	HR8LII33U	0242230523			HR8LPP33U	0242230577	HR8LPP30U	0242230558				
		1998-1999	HR9KII33Y	0242225659										
		1996-1997	HR8KII33Y	0242230536			HR8DPP33Y	0242230581	HR8DPP30Y	0242230559				
		1994-1999					HR9DPP33Y	0242225677	HR9DPP30Y	0242225670				
		1994-1995	HR8KII33V	0242230535										
G3	L4 1.6L	2007-2009	FR7DII33X	0242236596			FR7DPP33X	0242236631	FR7DPP30X	0242236616				
G5	L4 2.2L	2007-2009	HR8MII33X	0242230611			HR8MPP33X	0242230582	HR8MPP30X	0242230564				
	L4 2.4L	2007-2008	HR8MII33X	0242230611			HR8MPP33X	0242230582	HR8MPP30X	0242230564				
G6	V6 3.5L	2007-2009	HR9LII33X	0242225661			HR9LPP33X	0242225678	HR9LPP30X	0242225674				
		2005-2006	HR9KII33Y	0242225659			HR9DPP33Y	0242225677	HR9DPP30Y	0242225670				
	V6 3.6L	2007-2009	HR8NII332X	0242230530					HR8NPP302	0242229739				
Grand Am	V6 3.4L	2002-2004	HR9KII33Y	0242225659			HR9DPP33Y	0242225677	HR9DPP30Y	0242225670				
		1999-2001	HR8KII33Y	0242230536			HR8DPP33Y	0242230581	HR8DPP30Y	0242230559				
Grand Prix	V6 3.1L	1997-1998	HR8KII33Y	0242230536			HR8DPP33Y	0242230581	HR8DPP30Y	0242230559				
	V6 3.8L	1997-2001	HR9KII33Y	0242225659			HR9DPP33Y	0242225677	HR9DPP30Y	0242225670				
Matiz	L4 1.0L	2004-2010							WR8DPP30W	0242230599		WR8DCX+	0242229687	
Montana	V6 3.5L	2005-2006	HR9KII33Y	0242225659			HR9DPP33Y	0242225677	HR9DPP30Y	0242225670				
	V6 3.9L	2007-2009	HR9LII33X	0242225661			HR9LPP33X	0242225678	HR9LPP30X	0242225674			HR9DCY+	0242225623











P

Marca / Modelo	Motor	Años	Doble Iridio		Iridio		Doble Platino		Platino		Super 4		Níquel	
			Fórmula	Nº. de Parte	Fórmula	Nº. de Parte	Fórmula	Nº. de Parte	Fórmula	Nº. de Parte	Fórmula	Nº. de Parte	Fórmula	Nº. de Parte
Solstice	L4 2.0L	2009-2009			HR8NI332W	0242230508								
	L4 2.4L	2006-2008	HR8MII33X	0242230611			HR8MPP33X	0242230582	HR8MPP30X	0242230564				
Sunfire	L4 2.2L	2004-2005	HR8MII33X	0242230611			HR8MPP33X	0242230582	HR8MPP30X	0242230564				
	L4 2.4L	1997-2002	HR8KII33V	0242230535			HR8DPP33V	0242230583	HR8DPP30V	0242230561				
Torrent	V6 3.4L	2006-2008	HR9KII33Y	0242225659			HR9DPP33Y	0242225677	HR9DPP30Y	0242225670				

PORSCHE

911	H6 3.0L	2017-2019					ZR5NPP332SBP	0242145552							
	H6 3.4L	2012-2016											FGR5NQE04	0242245581	
		1999-2001											FGR6KQE	0242240587	
	H6 3.6L	2010-2012											FGR4NQE04	0242250518	
		2009-2012											FGR5NQE04	0242245581	
		2003-2004											FGR6KQE	0242240587	
		2002-2008											FGR5KQE0	0242245559	
		1998-1998											FR5DTC	0242245539	
		1996-2005									FR56	0242242501			
	H6 3.6L Turbo	1996-2004											FR6LDC	0242240566	
		2005-2005											FGR5KQE0	0242245559	
		2001-2005											FR6LDC	0242240566	
	H6 3.8L	1996-2001									FR56	0242242501			
		2017-2019						FR6NPP332	0242240637						
		2011-2012						FR6MPP332	0242240619						
		2010-2012											FGR4NQE04	0242250518	
2009-2016												FGR5NQE04	0242245581		
H6 3.8L Turbo	2005-2008											FGR5KQE0	0242245559		
	2010-2016						FR6NPP332	0242240637							
718 Boxster	H4 2.0L	2017-2019					ZR5NPP332SBP	0242145552							
718 Cayman	H4 2.0L	2017-2019					ZR5NPP332SBP	0242145552							
Boxster	H6 2.5L	1999-1999								FR7DPP30T	0242236618	FR78	0242232501	FR7LDC+	0242235668
	H6 2.7L	2013-2016												FGR5NQE04	0242245581
		2006-2008												FGR5KQE0	0242245559
		2001-2005												FGR6KQE	0242240587

 Marca / Modelo	 Motor	 Años	 Doble Iridio		 Iridio		 Doble Platino		 Platino		 Super 4		 Níquel		
			Fórmula	Nº. de Parte	Fórmula	Nº. de Parte	Fórmula	Nº. de Parte	Fórmula	Nº. de Parte	Fórmula	Nº. de Parte	Fórmula	Nº. de Parte	
Boxster	H6 2.9L	2010-2012											FGR5NQE04	0242245581	
	H6 3.2L	2006-2006											FGR5KQE0	0242245559	
		2001-2005											FGR6KQE	0242240587	
	H6 3.4L	2011-2016											FGR5NQE04	0242245581	
		2007-2008											FGR5KQE0	0242245559	
H6 3.8L	2016-2016											FGR5NQE04	0242245581		
Cayenne	V6 3.0L	2011-2018					FR5KPP332S	0242245576							
	V6 3.2L	2004-2006					YR7LPP332W	0242135510							
	V6 3.6L	2016-2018					FR5NPP332S	0242245585							
		2008-2010	YR6TII330T	0242140528											
	V8 4.5L	2003-2006											FGR6KQE	0242240587	
	V8 4.8L	2009-2018					FR6NPP332	0242240637							
		2009-2009					FR6MPP332	0242240619							
V8 4.8L Turbo	2008-2015					FR6NPP332	0242240637								
	2008-2014					FR6MPP332	0242240619								
Cayman	H6 2.7L	2014-2016											FGR5NQE04	0242245581	
		2007-2008											FGR5KQE0	0242245559	
	H6 2.9L	2009-2012											FGR5NQE04	0242245581	
	H6 3.4L	2009-2016												FGR5NQE04	0242245581
		2006-2008												FGR5KQE0	0242245559
H6 3.8L	2016-2016												FGR5NQE04	0242245581	
Macan	V6 3.0L	2015-2018					FR5NPP332S	0242245585							
	V6 3.6L	2015-2018					FR5NPP332S	0242245585							
Panamera	V6 3.0L	2014-2016					FR5NPP332S	0242245585							
		2012-2016					FR5KPP332S	0242245576							
	V6 3.6L	2012-2016											FGR5NQE04	0242245581	
	V8 4.8L	2010-2016											FGR5NQE04	0242245581	
	V8 4.8L Turbo	2010-2016					FR6NPP332	0242240637							
2010-2013						FR6MPP332	0242240619								



Marca / Modelo	Motor	Años	Doble Iridio		Iridio		Doble Platino		Platino		Super 4		Níquel	
			Fórmula	Nº. de Parte	Fórmula	Nº. de Parte	Fórmula	Nº. de Parte	Fórmula	Nº. de Parte	Fórmula	Nº. de Parte	Fórmula	Nº. de Parte

RAM

1500	V6 3.6L	2014-2018	YR7SII3320U	0242135574	YR7SII302U	0242135555								
	V6 3.7L	2011-2013											FR7LCX+	0242236542
		2011-2012	FR7LI33X	0242236592										
	V8 5.7L	2013-2019	FR8SII33X	0242230571										
2013-2013						FR8SPP33X	0242230604	FR8SPP30X	0242230576			FR8SEX	0242230624	
2500	V8 4.7L	2010-2010			FR8TI332	0242229764							FR8TE2	0242229765
	V8 5.7L	2011-2019	FR8SII33X	0242230571										
		2011-2016					FR8SPP33X	0242230604	FR8SPP30X	0242230576				
	2011-2013											FR8SEX	0242230624	
V8 6.4L	2018-2019	FR8SII332X	0242230618	FR8SI332	0242230596									
4000	V8 5.7L	2011-2019	FR8SII33X	0242230571										
		2011-2013				FR8SPP33X	0242230604	FR8SPP30X	0242230576			FR8SEX	0242230624	
V8 6.4L	2019-2019			FR8SI332	0242230596									
ProMaster 1500	V6 3.6L	2014-2019	YR7SII3320U	0242135574	YR7SII302U	0242135555								
ProMaster 2500	V6 3.6L	2014-2019	YR7SII3320U	0242135574										
		2014-2018			YR7SII302U	0242135555								
ProMaster 3500	V6 3.6L	2014-2019	YR7SII3320U	0242135574	YR7SII302U	0242135555								

RENAULT

Alliance	L4 1.4L	1984-1984					WR8LPP33X	0242230587						
	L4 1.7L	1985-1986							WR7DPP30W	0242236647			WR9DC+	0242225599
Clio	L4 1.6L	2002-2010							FR7DPP30X	0242236616			FR7DCX+	0242235667
	L4 2.0L	2002-2006					FR6KPP33X+	0242240649	FR8DPP30T	0242230572				
Duster	L4 2.0L	2013-2020					VR7SPP33	0242135524						
Encore	L4 1.7L	1985-1986							WR7DPP30W	0242236647			WR9DC+	0242225599
Euro Clio	L4 1.6L	2007-2008			FR6KI332S	0242240653			FR7DPP30X	0242236616	FR78X	0242232502	FR7DC+	0242235666
Fluence	L4 2.0L	2011-2017					VR7SPP33	0242135524						
Kangoo	L4 1.6L	2007-2009									FR78X	0242232502	FQR6DCW+	F000KE0P49
Kangoo Express	L4 1.6L	2004-2013							FR7DPP30X	0242236616	FR78X	0242232502	FQR6DCW+	F000KE0P49

Marca / Modelo	Motor	Años	Doble Iridio		Iridio		Doble Platino		Platino		Super 4		Níquel	
			Fórmula	Nº. de Parte	Fórmula	Nº. de Parte	Fórmula	Nº. de Parte	Fórmula	Nº. de Parte	Fórmula	Nº. de Parte	Fórmula	Nº. de Parte
Koleos	L4 2.5L	2009-2016	VR8NII35U*	0242129514*										
Laguna	L4 2.0L	2006-2006			FR7KI332S	0242236571	FR7KPP33U+	0242236544						
	V6 2.9L	2003-2006					FR8SPP332	0242229708						
Logan	L4 1.6L	2018-2019											FR7DCX+	0242235667
Megane	L4 1.6L	2008-2009			FR6KI332S	0242240653					FR78X	0242232502	FR7DC+	0242235666
	L4 2.0L	2003-2010									FR78X	0242232502		
		2003-2009			FR6KI332S	0242240653							FR7DC+	0242235666
L4 2.0L Turbo	2005-2009							FR7DPP+	0242235749					
R12	L4 1.3L	1974-1983											WR7BC+	0242235665
	L4 1.6L	1975-1977											WR7DC+	0242235663
R18	L4 1.6L	1980-1984								WR78	0242232504	WR7DC+	0242235663	
R5	L4 1.3L	1981-1981										WR7BC+	0242235665	
Sandero	L4 1.6L	2010-2015											FR7DCX+	0242235667
		2010-2014											FR7DC+	0242235666
	2010-2011									FR78	0242232501			
L4 2.0L	2016-2020											FR7DC+	0242235666	
Scenic	L4 2.0L	2004-2004			FR6KI332S	0242240653					FR78X	0242232502		
		2001-2004											FR7DC+	0242235666
		2001-2003					FR7DPP33X	0242236631	FR7DPP30T	0242236618				
Scenic II	L4 2.0L	2005-2008			FR6KI332S	0242240653				FR78X	0242232502	FR7DC+	0242235666	
Stepway	L4 1.6L	2010-2019										FR7DCX+	0242235667	

ROVER

75	V6 2.5L	2000-2005					FR7KPP33U+	0242236544						
----	---------	-----------	--	--	--	--	------------	------------	--	--	--	--	--	--

SAAB

9-3	L4 2.0L	2001-2009					FR6KPP33X+	0242240649						
9-5	L4 2.3L	2006-2006											FR5DC	0242245536
		2002-2006											FR7DCX+	0242235667
		2001-2006					FR6KPP33X+	0242240649						
V6 3.0L	2001-2001					FR6KPP33X+	0242240649							



Marca / Modelo	Motor	Años	Doble Iridio		Iridio		Doble Platino		Platino		Super 4		Níquel	
			Fórmula	Nº. de Parte	Fórmula	Nº. de Parte	Fórmula	Nº. de Parte	Fórmula	Nº. de Parte	Fórmula	Nº. de Parte	Fórmula	Nº. de Parte

SEAT

Alhambra	L4 1.8L	2002-2007					FR7KPP33+	0242236564						
	V6 2.8L	2007-2008					FR7HPP33+	0242236566						
Altea	L4 1.4L	2010-2012			FR6HI332	0242240665								
Altea XL	L4 1.8L	2010-2015					FR5KPP332S	0242245576						
Cordoba	L4 1.6L	2007-2009											FR6LES	0242240659
		2004-2009										FLR7HTC0	0242235788	
		2001-2009								FR78X	0242232502			
		2001-2002			FR6KI332S	0242240653			FR7DPP30T	0242236618			FR7LDC+	0242235668
	L4 2.0L	2003-2009			FR6KI332S	0242240653			FR7DPP30T	0242236618	FR78X	0242232502	FR7LDC+	0242235668
Exeo	L4 2.0L	2011-2011					FR5KPP332S	0242245576						
Freerack	L4 2.0L	2010-2013					FQ5NPP332S	0241245673						
		2009-2015					FR5KPP332S	0242245576						
Ibiza	L4 1.2L	2016-2017					Y5KPP332	0241145523						
		2013-2015			FR6HI332	0242240665								
	L4 1.4L	2011-2012			FR6HI332	0242240665								
	L4 1.6L	2004-2009											FLR7HTC0	0242235788
		2001-2015								FR78X	0242232502	FR7LDC+	0242235668	
	L4 1.8L	2005-2008					FR7KPP33+	0242236564			FR78	0242232501		
	L4 2.0L	2003-2015											FR7LDC+	0242235668
2003-2009									FR78X	0242232502				
Leon	L4 1.4L	2014-2018					Y5KPP332	0241145523						
		2008-2013			FR6HI332	0242240665								
	L4 1.6L	2007-2007								FR78X	0242232502	FR7LDC+	0242235668	
	L4 1.8L	2010-2013						FR5KPP332S	0242245576					
		2005-2005								FR7DPP30T	0242236618			
		2004-2004						FR7KPP33+	0242236564			FR78	0242232501	
		2001-2004									FR78X	0242232502	FR7LDC+	0242235668
	L4 1.8L Turbo	2001-2003					FR7KPP33+	0242236564			FR78	0242232501		
	L4 2.0L	2009-2013						FR5KPP332S	0242245576					
2006-2008				FR6KI332S	0242240653							FR7DE2	0242235797	
L4 2.0L Turbo	2007-2008					FR5KPP332S	0242245576							

Marca / Modelo	Motor	Años	Doble Iridio		Iridio		Doble Platino		Platino		Super 4		Níquel	
			Fórmula	Nº. de Parte	Fórmula	Nº. de Parte	Fórmula	Nº. de Parte	Fórmula	Nº. de Parte	Fórmula	Nº. de Parte	Fórmula	Nº. de Parte
Legacy	H4 2.0L	2008-2009			FR7NI33	0242236528								
	H4 2.5L	2014-2015	VR7SII33U	0242135553										
		2010-2012	FR7KII33X	0242236599			FR7DPP33X	0242236631	FR7DPP30X	0242236616				
		2009-2009	FR8KII33X	0242230528			FR8DPP33X	0242230579	FR8DPP30X	0242230557				
	H4 2.5L Turbo	2006-2007	FR6NII332S	0242240715										
	H6 3.0L	2008-2009			FR7NI33	0242236528								
H6 3.6L	2014-2015	FR7NII33X	0242236593			FR7MPP33X	0242236630	FR7NPP30X	0242236619					
Outback	H4 2.5L	2014-2017	VR7SII33U	0242135553										
		2010-2012	FR7KII33X	0242236599			FR7DPP33X	0242236631	FR7DPP30X	0242236616				
		2006-2008	FR6NII332S	0242240715										
	H6 3.6L	2010-2017	FR7NII33X	0242236593			FR7MPP33X	0242236630	FR7NPP30X	0242236619				
Tribeca	H6 3.6L	2010-2012	FR7NII33X	0242236593			FR7MPP33X	0242236630	FR7NPP30X	0242236619				
		2008-2009	FR6NII332S	0242240715										
WRX	H4 2.0L	2018-2020	FR6NII332S	0242240715										
	2015-2019	VR6NII332	0242140557											
WRX STI	H4 2.5L	2012-2016	FR6NII332S	0242240715										
		2020-2020	VR6NII332	0242140557										
WRX STI	H4 2.5L	2017-2019	FR6NII332S	0242240715										
		2020-2020	VR6NII332	0242140557										
XV	H4 2.0L	2013-2016	VR7SII33U	0242135553										

SUZUKI









Aerio	L4 2.3L	2006-2007	FR8KII33X	0242230528			FR8DPP33X	0242230579	FR8DPP30X	0242230557				
Grand Vitara	L4 2.4L	2009-2017	FR7NII33X	0242236593			FR7MPP33X	0242236630	FR7NPP30X	0242236619				
	V6 2.7L	2007-2008									FR78X	0242232502		
		2006-2008	FR7KII33X	0242236599			FR6KPP33X+	0242240649						
	V6 3.2L	2009-2010	HR8NII332X	0242230530					HR8NPP302	0242229739				
Ignis	L4 1.2L	2017-2021	YR8SII33U	0242129524										
Kizashi	L4 2.4L	2015-2016											YR8SEU	0242129515
		2010-2014	FR7NII33X	0242236593			FR7MPP33X	0242236630	FR7NPP30X	0242236619				
Swift	L4 1.5L	2007-2011					FR6KPP33X+	0242240649						
	L4 1.6L	2013-2017	FR7NII33X	0242236593			FR7MPP33X	0242236630	FR7NPP30X	0242236619				
SX4	L4 2.0L	2008-2009	FR8KII33X	0242230528			FR8DPP33X	0242230579	FR8DPP30X	0242230557				
Vitara	L4 1.6L	2016-2016	FR7NII33X	0242236593			FR7MPP33X	0242236630	FR7NPP30X	0242236619				

Marca / Modelo	Motor	Años	Doble Iridio		Iridio		Doble Platino		Platino		Super 4		Níquel	
			Fórmula	Nº. de Parte	Fórmula	Nº. de Parte	Fórmula	Nº. de Parte	Fórmula	Nº. de Parte	Fórmula	Nº. de Parte	Fórmula	Nº. de Parte

TOYOTA

4Runner	V6 4.0L	2006-2007	FR7NII33X	0242236593			FR7MPP33X	0242236630	FR7NPP30X	0242236619	FR78NX	0242232515		
	V8 4.7L	2003-2008	FR7KII33X	0242236599			FR7DPP33X	0242236631	FR7DPP30X	0242236616				
Avanza	L4 1.5L	2016-2020	VR8SII33X	0242129529										
		2007-2012									YR78X	0242132501	YR7DC+	0242135515
Camry	L4 2.4L	2002-2009	FR7KII33X	0242236599			FR7DPP33X	0242236631	FR7DPP30X	0242236616				
	L4 2.5L	2010-2017	FR8MII33X	0242230533			FR8MPP33X	0242230584	FR8MPP30X	0242230562				
	V6 3.0L	2002-2006	FR7KII33X	0242236599			FR7DPP33X	0242236631	FR7DPP30X	0242236616				
	V6 3.5L	2017-2017	FR7KII33X	0242236599			FR7DPP33X	0242236631	FR7DPP30X	0242236616				
2007-2017		FR7NII35U*	0242236605*											
C-HR	L4 2.0L	2018-2020	VR8SII33X	0242129529										
Corolla	L4 1.8L	2009-2019	VR8SII33X	0242129529										
		2009-2009											FR7KCX+	0242236541
		2003-2009	FR8KII33X	0242230528			FR8DPP33X	0242230579	FR8DPP30X	0242230557				
	L4 2.4L	2003-2008									FR78X	0242232502		
		2009-2013	FR7KII33X	0242236599			FR7DPP33X	0242236631						
	2009-2012							FR7DPP30X	0242236616					
FJ Cruiser	V6 4.0L	2014-2014	FR8MII33X	0242230533			FR8MPP33X	0242230584	FR8MPP30X	0242230562				
		2008-2014	FR7NII33X	0242236593			FR7MPP33X	0242236630	FR7NPP30X	0242236619				
Hiace	L4 2.7L	2006-2019									FR78NX	0242232515		
		2006-2017	FR7NII33X	0242236593			FR7MPP33X	0242236630	FR7NPP30X	0242236619				
Highlander	V6 3.5L	2017-2020	FR7NII35S*	0242236604*										
		2014-2016	FR7KII33X	0242236599			FR7DPP33X	0242236631	FR7DPP30X	0242236616				
		2008-2016	FR7NII35U*	0242236605*										
Hilux	L4 2.7L	2009-2016									FR78NX	0242232515		
		2004-2020	FR7NII33X	0242236593			FR7MPP33X	0242236630	FR7NPP30X	0242236619				
Land Cruiser	V8 4.7L	2004-2007	FR7KII33X	0242236599			FR7DPP33X	0242236631	FR7DPP30X	0242236616				
	V8 5.7L	2008-2019	FR7NII33X	0242236593			FR7MPP33X	0242236630	FR7NPP30X	0242236619				
Matrix	L4 1.8L	2009-2010	VR8SII33X	0242129529										
		2008-2008											FR8DCX+	0242229660
		2003-2008	FR8KII33X	0242230528			FR8DPP33X	0242230579	FR8DPP30X	0242230557				
	L4 2.4L	2009-2010	FR7KII33X	0242236599			FR7DPP33X	0242236631	FR7DPP30X	0242236616				



 Marca / Modelo	 Motor	 Años	 Doble Iridio		 Iridio		 Doble Platino		 Platino		 Super 4		 Níquel	
			Fórmula	Nº. de Parte	Fórmula	Nº. de Parte	Fórmula	Nº. de Parte	Fórmula	Nº. de Parte	Fórmula	Nº. de Parte	Fórmula	Nº. de Parte
MR2 Spyder	L4 1.8L	2006-2006											FR8DCX+	0242229660
		2005-2006	FR8KII33X	0242230528			FR8DPP33X	0242230579	FR8DPP30X	0242230557	FR78X	0242232502		
Prius	L4 1.8L	2016-2017	VR8NII35U*	0242129514*										
		2010-2015	VR8SII33X	0242129529										
Prius C	L4 1.5L	2018-2019	FR7KII35T*	0242236670*										
RAV4	L4 2.4L	2004-2008	FR7KII33X	0242236599				FR7DPP33X	0242236631	FR7DPP30X	0242236616			
	L4 2.5L	2009-2018	FR8MII33X	0242230533				FR8MPP33X	0242230584	FR8MPP30X	0242230562			
	V6 3.5L	2009-2012	FR7NII35U*	0242236605*										
Sequoia	V8 4.7L	2009-2012											FR8DC+	0242229659
		2008-2012	FR7KII33X	0242236599			FR7DPP33X	0242236631	FR7DPP30X	0242236616				
	V8 5.7L	2009-2019	FR7NII33X	0242236593			FR7MPP33X	0242236630	FR7NPP30X	0242236619				
Sienna	V6 3.0L	2003-2003	FR7KII33X	0242236599	FR6K1332S	0242240653	FR7DPP33X	0242236631	FR7DPP30X	0242236616	FR78X	0242232502		
	V6 3.3L	2004-2006	FR7KII33X	0242236599			FR7DPP33X	0242236631	FR7DPP30X	0242236616				
	V6 3.5L	2017-2020	FR7NII35S*	0242236604*										
2007-2016		FR7NII35U*	0242236605*											
Solara	V6 3.3L	2005-2006	FR7KII33X	0242236599			FR7DPP33X	0242236631	FR7DPP30X	0242236616				
Tacoma	V6 3.5L	2016-2020	FR7NII35S*	0242236604*										
	V6 4.0L	2006-2015	FR7NII33X	0242236593			FR7MPP33X	0242236630	FR7NPP30X	0242236619				
Tundra	V6 4.0L	2007-2007	FR7NII33X	0242236593			FR7MPP33X	0242236630	FR7NPP30X	0242236619				
	V8 4.7L	2007-2010	FR7KII33X	0242236599			FR7DPP33X	0242236631	FR7DPP30X	0242236616				
	V8 5.7L	2009-2020	FR7NII33X	0242236593			FR7MPP33X	0242236630	FR7NPP30X	0242236619				
Yaris	L4 1.3L	2004-2005	FR8KII33X	0242230528	FR6K1332S	0242240653			FR8DPP30T	0242230572	FR78	0242232501		
	L4 1.5L	2010-2012											FR8DC+	0242229659
		2006-2016	FR8KII33X	0242230528			FR8DPP33X	0242230579	FR8DPP30X	0242230557				
Yaris R	L4 1.5L	2016-2020	VR7NII33X	0242135529										

VOLKSWAGEN

Amarok	L4 2.0L	2012-2014					FR5KPP332S	0242245576						
Atlantic	L4 1.6L	1981-1981							WR7DPP30W	0242236647	WR78	0242232504	WR7DC+	0242235663
	L4 1.7L	1984-1987							WR7DPP30W	0242236647				
1984-1984											WR78X	0242232505	W7DTC	0241236839
Beetle	L4 1.8L	2000-2005					FR7KPP33+	0242236564			FR78	0242232501		
	L4 2.0L	2015-2017					FQ5NPP332S	0241245673						

Marca / Modelo	Motor	Años	Doble Iridio		Iridio		Doble Platino		Platino		Super 4		Níquel		
			Fórmula	Nº. de Parte	Fórmula	Nº. de Parte	Fórmula	Nº. de Parte	Fórmula	Nº. de Parte	Fórmula	Nº. de Parte	Fórmula	Nº. de Parte	
Beetle	L4 2.0L	2012-2013					FR5KPP332S	0242245576							
		2003-2003											FR6DC+	0242240593	
		2000-2009						FR7HPP33+	0242236566						
		1998-2005										FR78X	0242232502		
		1998-2001			FR6KI332S	0242240653				FR7DPP30T	0242236618			FR7LDC+	0242235668
	1998-1998	FR6KII33X	0242240669												
	L5 2.5L	2009-2014												FR7HE02	0242236530
		2008-2010										FR78X	0242232502		
2008-2008							FR7HPP33+	0242236566							
Beetle Cabrio	L5 2.5L	2010-2010					FR7KPP33+	0242236564			FR78X	0242232502	FR7HE02	0242236530	
Bora	L4 2.0L	2006-2009					FR5KPP332S	0242245576							
	L5 2.5L	2008-2010											FR7HE02	0242236530	
		2006-2010										FR78X	0242232502		
		2006-2007						FR7HPP33+	0242236566						
Cabrio	L4 2.0L	1996-2002							FR8DPP30T	0242230572					
Caddy	L4 1.2L	2014-2015	FR6HI332	0242240665											
	L4 1.6L	2018-2020											Y7LER02	0241135520	
CC	L4 2.0L	2014-2017					FR5KPP332S	0242245576							
	V6 3.6L	2013-2013	YR6TII330T	0242140528											
Clasico	L4 1.8L	2011-2012					FR7KPP33+	0242236564			FR78	0242232501			
	L4 2.0L	2011-2015											FLR7HTC0	0242235788	
Combi	H4 1.6L	1984-1988									WR78	0242232504			
		1974-1979							WR8APP30T	0242230603			W7DC	0241235755	
		1974-1979											WR6DC+	0242240592	
	L4 1.8L	1988-1994											W8DC	0241229715	
1988-1994												WR9DC+	0242225599		
Corsar	L4 1.8L	1986-1988								WR78	0242232504	WR7DC+	0242235663		
CrossFox	L4 1.6L	2007-2009											FLR7HTC0	0242235788	
Derby	L4 1.8L	2002-2009												WR7LTC+	0242235664
		2002-2002												WR7LT+	F000KE0P05
		1998-2009								FR7DPP30T	0242236618	WR78X	0242232505		
		1998-2002												W7DTC	0241236839
		1995-1997												FR7LDC+	0242235668



V







Marca / Modelo	Motor	Años	Doble Iridio		Iridio		Doble Platino		Platino		Super 4		Níquel	
			Fórmula	Nº. de Parte	Fórmula	Nº. de Parte	Fórmula	Nº. de Parte	Fórmula	Nº. de Parte	Fórmula	Nº. de Parte	Fórmula	Nº. de Parte
Derby	L4 2.0L	2002-2003							FR8DPP30T	0242230572			WR7LTC+	0242235664
Eos	L4 2.0L	2010-2010					FR5KPP332S	0242245576						
EuroVan	L5 2.5L	2001-2004									FR78X	0242232502		
		2001-2003											FR7LDC+	0242235668
Gol	L4 1.6L	2000-2000	FR8KII33X	0242230528			FR8DPP33X	0242230579	FR8DPP30X	0242230557			F6DTC	0241240609
		2000-2000											FGR8KQE	0242229613
Gol	L4 1.6L	2016-2019					FR7HPP33+	0242236566						
		2009-2013											FLR7HTC0	0242235788
Gol Sedan	L4 1.6L	2010-2012											FR5DE2	F000KE0P30
Golf	L4 1.8L	1993-1998											W7DTC	0241236839
		1993-1998											WR7LTC+	0242235664
		1993-1998											WR7LT+	F000KE0P05
		1991-1991											W8DC	0241229715
		1989-1998									WR78	0242232504		
		1989-1989									FR56	0242242501	F6DTC	0241240609
		1987-1992							WR7DPP30W	0242236647				
		1987-1991											WR7DC+	0242235663
	L4 2.0L	1987-1988									WR78X	0242232505		
		2002-2003	FR6KII33X	0242240669										
		2001-2006					FR7HPP33+	0242236566						
		2000-2001					FR7KPP33+	0242236564						
		1999-2007			FR6KI332S	0242240653			FR7DPP30T	0242236618	FR78X	0242232502	FR7LDC+	0242235668
		1995-1999							FR8DPP30T	0242230572				
V6 2.8L	1996-1998					FR8DPP33X	0242230579					FGR8KQE	0242229613	
Golf R	L4 2.0L	2018-2019					FQ5NPP332S	0241245673						
GTI	L4 2.0L	2018-2018					FQ5NPP332S	0241245673						
		2007-2013					FR5KPP332S	0242245576						
Jetta	L4 1.8L	2005-2005									FR78	0242232501		
		2000-2010					FR7KPP33+	0242236564						
		1999-1999											WR7DC+	0242235663
		1993-1998									WR78X	0242232505	WR7LTC+	0242235664
		1990-1998							WR7DPP30W	0242236647				
1990-1992												W7DTC	0241236839	

Marca / Modelo	Motor	Años	Doble Iridio		Iridio		Doble Platino		Platino		Super 4		Níquel		
			Fórmula	Nº. de Parte	Fórmula	Nº. de Parte	Fórmula	Nº. de Parte	Fórmula	Nº. de Parte	Fórmula	Nº. de Parte	Fórmula	Nº. de Parte	
Jetta	L4 1.8L	1987-1999									WR78	0242232504			
		1987-1989											W8DC	0241229715	
		1987-1989											WR6DC+	0242240592	
	L4 1.8L Turbo	1999-1999					FR7KPP33+	0242236564							
	L4 2.0L	2019-2019						FQ5NPP332S	0241245673						
		2013-2015												FR7HE02	0242236530
		2012-2015						FR6KPP332S	0242240627						
		2005-2010												FLR7HTC0	0242235788
		2001-2004						FR7HPP33+	0242236566						
		1999-2015										FR78X	0242232502		
		1999-2004												FR7LDC+	0242235668
		1999-2001	FR6KII33X	0242240669						FR7DPP30T	0242236618				
	1993-1998								FR8DPP30T	0242230572					
	L4 2.0L Turbo	2016-2017						FQ5NPP332S	0241245673						
L4 2.0L Turbo	2007-2008						FR5KPP332S	0242245576							
L5 2.5L	2011-2018						FR6KPP332S	0242240627							
V6 2.8L	1999-2002	FR8KII33X	0242230528				FR8DPP33X	0242230579	FR8DPP30X	0242230557			FGR8KQE	0242229613	
Lupo	L4 1.6L	2005-2009											FR7LDC+	0242235668	
Passat	L4 1.8L	2002-2005									FR78	0242232501			
		1999-2005					FR7KPP33+	0242236564							
	L4 2.0L	2006-2010					FR5KPP332S	0242245576							
	L5 2.5L	2012-2017												FR7HE02	0242236530
		2012-2016									FR78X	0242232502			
	V6 2.8L	1999-2005	FR6KII33X	0242240669										FGR7DQE+	0242235748
		1996-1997												FGR8KQE	0242229613
V6 3.6L	2006-2018	YR6TII330T	0242140528												
W8 4.0L	2003-2004						FR7KPP33+	0242236564			FR78X	0242232502			
Passat CC	L4 2.0L	2010-2010					FR5KPP332S	0242245576							
	V6 3.6L	2010-2010	YR6TII330T	0242140528											
Pointer	L4 1.8L	2006-2009								WR7DPP30W	0242236647				
		2005-2009												FLR7HTC0	0242235788
		1998-2005										WR78X	0242232505	WR7LTC+	0242235664
Pointer Truck	L4 1.8L	2006-2006									FR78X	0242232502	FR7HE02	0242236530	



V

 Marca / Modelo	 Motor	 Años	 Doble Iridio		 Iridio		 Doble Platino		 Platino		 Super 4		 Níquel		
			Fórmula	Nº. de Parte	Fórmula	Nº. de Parte	Fórmula	Nº. de Parte	Fórmula	Nº. de Parte	Fórmula	Nº. de Parte	Fórmula	Nº. de Parte	
Pointer Truck	L4 1.8L	1999-2005									WR78X	0242232505	WR7LTC+	0242235664	
Polo	L4 1.2L	2016-2017					Y5KPP332	0241145523							
		2013-2014	FR6HI332	0242240665											
	L4 1.4L	2013-2013	FR6HI332	0242240665											
		2007-2007												FLR7HTC0	0242235788
		2003-2006												F6DTC	0241240609
R32	L4 1.8L	2017-2017					FQ5NPP332S	0241245673							
Routan	V6 3.2L	2003-2003					YR7LPP332W	0242135510							
	V6 3.6L	2011-2012	YR7SII3320U	0242135574	YR7SII302U	0242135555									
Saveiro	V6 3.8L	2009-2010	HR8TII3302V	0242230526			HR8TPP3302V	0242230586	HR8TPP3002V	0242230566					
	L4 1.6L	2010-2015												FR5DE2	F000KE0P30
Sedan	H4 1.6L	1993-2004												WR9DC+	0242225599
	H4 1.6L	1973-2004							WR8DPP30W	0242230599					
Sharan	L4 1.8L	2002-2008					FR7KPP33+	0242236564			FR78	0242232501			
SportVan	L4 1.6L	2007-2010											FR7LDC+	0242235668	
Tiguan	L4 1.4L	2013-2015			FR6HI332	0242240665									
	L4 2.0L	2009-2017					FR5KPP332S	0242245576							
Touareg	V6 3.0L	2013-2015					FR5KPP332S	0242245576							
	V6 3.2L	2004-2006					YR7LPP332W	0242135510							
	V6 3.6L	2008-2017	YR6TII330T	0242140528											
	V8 4.2L	2004-2007	FR6KII33X	0242240669										FGR7KQE0	0242235715
Up!	L3 1.0L	2016-2018											Y7LER02	0241135520	
Van	L4 1.8L	2003-2009							FR7DPP30T	0242236618			W7DTC	0241236839	
Vento	L4 1.6L	2014-2020					FR7HPP33+	0242236566					FR7HE02	0242236530	
Virtus	L4 1.6L	2020-2021											Y7LER02	0241135520	

VOLVO







C30	L5 2.4L	2008-2010												FGR6NQE0	0242240635
	L5 2.5L	2012-2013	FR7NII35U*	0242236605*											
C70		2008-2013			FR7NI33	0242236528			FR7MPP10	0242235743					
	L5 2.3L	1999-2001							FR7DPP+	0242235749				FR7DC+	0242235666
	L5 2.4L	2003-2004												FR7DC+	0242235666
		2002-2004							FR7DPP+	0242235749					

Marca / Modelo	Motor	Años	Doble Iridio		Iridio		Doble Platino		Platino		Super 4		Níquel	
			Fórmula	Nº. de Parte	Fórmula	Nº. de Parte	Fórmula	Nº. de Parte	Fórmula	Nº. de Parte	Fórmula	Nº. de Parte	Fórmula	Nº. de Parte
C70	L5 2.5L	2012-2013	FR7NII35U*	0242236605*										
		2006-2013			FR7NI33	0242236528			FR7MPP10	0242235743				
S40	L4 1.9L	2001-2003											FR7DC+	0242235666
		1999-2004							FR7DPP+	0242235749				
	L4 2.0L	2011-2011					HR7KPP33+	0242236563						
	L5 2.4L	2007-2010											FGR6NQE0	0242240635
	L5 2.5L	2004-2012			FR7NI33	0242236528								
		2004-2011							FR7MPP10	0242235743				
S60	L4 1.6L	2011-2015	HR7TII3320T	0242236683										
	L5 2.0L	2004-2004							FR7MPP10	0242235743				
		2001-2004							FR7DPP+	0242235749				
	L5 2.3L	2001-2005							FR7DPP+	0242235749				
	L5 2.4L	2006-2008			FR7NI33	0242236528			FR7MPP10	0242235743				
		2001-2003							FR7DPP+	0242235749			FR7DC+	0242235666
	L5 2.5L	2004-2007			FR7NI33	0242236528			FR7MPP10	0242235743				
		2004-2007							FR7DPP+	0242235749				
L6 3.0L	2015-2015							FR7DPP+	0242235749					
		2011-2015	FR7NII35U*	0242236605*										
S60 Cross Country	L5 2.5L	2016-2016	FR7NII35S*	0242236604*										
S70	L5 2.3L	2000-2000							FR7DPP+	0242235749			FR7DC+	0242235666
	L5 2.4L	2000-2000							FR7DPP+	0242235749				
		1999-1999											FR7DC+	0242235666
S80	L5 2.5L	2005-2006							FR7DPP+	0242235749				
	L6 2.8L	2002-2003	FR7DII33X	0242236596			FR7DPP33X	0242236631	FR7DPP30T	0242236618				
		1999-2001							FR7DPP+	0242235749				
		1999-2000											FR7DC+	0242235666
	L6 2.9L	2004-2006							FR7DPP+	0242235749				
		2000-2003											FGR7DQE+	0242235748
	L6 3.0L	2011-2015	FR7NII35U*	0242236605*										
2010-2015				FR7NI33	0242236528									
L6 3.2L	2008-2009			FR7NI33	0242236528									
V8 4.4L	2010-2010	FR7KII33X	0242236599			FR7KPP33U+	0242236544	FR7DPP30X	0242236616					



V



Marca / Modelo	Motor	Años	 Doble Iridio		 Iridio		 Doble Platino		 Platino		 Super 4		 Níquel	
			Fórmula	Nº. de Parte	Fórmula	Nº. de Parte	Fórmula	Nº. de Parte	Fórmula	Nº. de Parte	Fórmula	Nº. de Parte	Fórmula	Nº. de Parte
V40	L4 1.6L	2014-2015	HR7TII3320T	0242236683										
	L4 1.9L	2001-2003											FR7DC+	0242235666
		2000-2004							FR7DPP+	0242235749				
		1999-1999							FR7DPP30T	0242236618				
	L4 2.0L	2014-2015			FR7NI33	0242236528								
L5 2.0L	2014-2015			FR7NI33	0242236528									
V50	L5 2.5L	2005-2007			FR7NI33	0242236528			FR7MPP10	0242235743				
V60 Cross Country	L5 2.5L	2016-2016	FR7NII35S*	0242236604*										
V70	L5 2.3L	2000-2003							FR7DPP+	0242235749				
		2000-2000											FR7DC+	0242235666
XC60	L5 2.4L	1999-2003							FR7DPP+	0242235749			FR7DC+	0242235666
	L5 2.5L	2016-2016	FR7NII35S*	0242236604*										
XC60	L6 3.0L	2010-2015	FR7NII35U*	0242236605*	FR7NI33	0242236528								
XC70	L5 2.5L	2004-2007							FR7DPP+	0242235749				
XC90	L5 2.5L	2004-2006							FR7DPP+	0242235749			FR7DC+	0242235666
	L6 2.9L	2003-2006							FR7DPP+	0242235749			FR7DC+	0242235666
	L6 3.2L	2007-2010			FR7NI33	0242236528								
	V8 4.4L	2006-2010	FR7KII33X	0242236599			FR7KPP33U+	0242236544	FR7DPP30X	0242236616				

CATALOGO DE **BOMBAS DE COMBUSTIBLE**



Código	Descripción	N° Original
BEDFORD - BORGWARD - INDENOR		
6020	Bedford - Chevrolet	2636013
6364	Borgward VM. - Incluye O`Ring.	B5182004A
6365	Borgward Ford. - Incluye O`Ring.	B5182003A
6400	Indenor	
CUMMINS		
6640S	Cummins B 3.9 y 5.9 ; Bomba Iny. Rotativa ; Entrada 1/4 NPTF ; Salida M14x1,5	3904374 3966154 3970880 4983584
6641S	Cummins B 3.9 y 5.9 Bomba Iny. Rotativa ; Entrada y salida M14x1.5 - Ford F-100	3928144 3966155 3970881 4988769
6650	Cummins 6CTAA - 6CTA – 6CT (8.3 litros, 300 HP) ; - Ford 1730 - VW 17300 Entrada ½ NPTF ; Salida M14x1,5 (Largo 12mm)	393 2224 393 3252 393 3253 498 8747 341 5661
6654	Cummins 6CTAA - 6CTA – 6CT – 6C (hasta 200 HP) ; - Ford 1722 / 1522 - VW 17220 / 15220 Entrada NPTF ; Salida 14x1,5 (Largo 28mm)	393 6318 393 6319 393 0202 493 7767
6656	Cummins BT – 6 cilindros con bomba lineal - Ford 1416 - VW 14160 Entrada NPTF ; Salida M14x1,5 (Largo 12mm)	393 2227 498 8748
DEUTZ		
9230	Deutz B/F 3,4,5,6 L 812 - 912 – 912 W – 913 W/T	0423 1021 0415 0197 0210 0087 0223 9550 0423 8003
FIAT - IVECO		
9210	IVECO Series 40, 50, 55, 65, 70, 616 N3/4	4673618 4709284 4740719 4757884 4802839
9212	IVECO Series 8040, 8060. No aplica en Argentina	4800420 4802838
9214	IVECO Serie 8065. No aplica en Argentina	98419724
9216	IVECO Series 8031, 8035, 8041, 8045	4609596 4648022 4660069 4667509 4709282 4740717 4756678 4757883 504090935
9218	IVECO 8045. No aplica en Argentina	99485050
9220	IVECO 8140 Diesel 2.5 lt (hasta 1983). No aplica en Argentina	4279496 4724625 4740996 4749880 4755893

Código	Descripción	Nº Original
FORD		
2658S	Ford Transit 2,5 Turbodiesel	91-4F 9350 AA 90-4F 9350 AB
JOHN DEERE		
6500	ohn Deere 3, 4, 6 cilindros	5507019 RE42211 AR77914 AR53567 RE37482
6501	ohn Deere 3,4,6 cilindros (con vaso de vidrio y filtro) , hasta 1989	A 52379 AR 92777
6502	ohn Deere 3,4,6 cilindros (hasta 1989). No aplica en Argentina	AR 57264
6504S	ohn Deere Power Tech (sin conectores). Palanca cebadora invertida	RE517230
6505S	ohn Deere. Equipo original desde 2000. Sellada	RE 38009
6506S	ohn Deere. Equipo original desde 2000. Sellada	RE 55390
6507S	ohn Deere. Motores Power Tech (desde 2002). Entrada conector roscado.	RE66153 RE535728 RE545665
6508S	ohn Deere Power Tech (sin conectores)	RE559087
6509S	ohn Deere. Motores Power Tech (desde 2002). Entrada ca o recto	RE68345 RE535727 RE545664
MAXION PARA FORD, CHEVROLET, M. BENZ, LAND ROVER		
6600S	Maxion , GM S10 , Ford Ranger , Chevrolet Blazer	72100
6601S	Maxion Ford Ranger , Motor Power Stroke 2,8	72119
6609S	Land-Rover , Defender , Discovery , 300 TDI	ERR 5057 7002871C1
6610S	Maxion , Mercedes Benz Sprinter	72103
MWM		
6620	MWM motor 229 , F-100 , F-1000/4000	9052002000040 7001752C1
6630	MWM motor 410MA / T / TCA , 410T , F-1000/4000 (modelo tamaño grande)	9052002000041 7001753C1
6631	MWM motor 410MA / T / TCA, 410T (modelo tamaño pequeño)	9052002000043 7001754C1
9125S	MWM Sprint 6 cil. , GM Silverado DL , F100 LT	9052002000046 7002479C1
9126S	MWM Sprint 6 cil. , GM Silverado DL	9052002000044 7001751C1
PERKINS / MAXION		
0354	Perkins 6.354-4 Turbo Fase 4 , 6 cilindros (cara de montaje 17mm)	005365
0354K	Perkins / Maxion 6.354-4 (cara de montaje 10mm)	72096
1529K	Perkins (Europa) 4.203 (No aplica en Argentina y Brasil)	25061512







Código	Descripción	Nº Original
PERKINS / MAXION		
1678K	Perkins / Maxion 6.357.2 / 6.358	72082
1695K	Perkins / Maxion 3.152 , 3 cilindros	72094
1696K	Perkins / Maxion 3.152 , MF 50 / 55 / 235 / 250	72084 72023
1756K	Perkins (Europa) 4.203 (cara de monta e 8mm) (No aplica en Argentina y Brasil)	25061507
1811	Perkins / Maxion MS P-4001T 4 / 6 cilindros hasta 2011	72111
1812	Perkins / Maxion MS P-4001T 4 / 6 cilindros desde 2011	72145 7004982C1 7005467R1
1870K	Perkins / Maxion 4.203 / D4.203 / 4.154 , MF 265 (nuevo diseño similar a la original)	7004982C1
1883	Perkins / Maxion 4.236 / 4.248	72083
1885	Perkins / Maxion 4.203	72085
1987K	Perkins / Maxion 3.152 , 3 cilindros	2641712 2641704
2563K	Perkins 6.354 F4	25061561
2567K	Perkins / Maxion 4.236 / 4.212 / 4.248 , Entrada y Salida 180°	2641A055 72095
2568K	Perkins / Maxion 4.236 / 4.238 / 4.248 / T4.236A / MF 292 / CBT	72042
2693K	Perkins / Maxion 4.236 F4 (cara de monta e 10mm)	
3152	Perkins / Maxion 3.152, (3 cilindros)	005859
4203/6305	Perkins / Maxion 4.203 / 6.305 6.357 / 6.358 / 6.340 / 6.288	005533 005236 72093 2641371
4236	Perkins / Maxion 4.236 , GM D-20 (monta e con 4 agujeros)	72081
4354K	Perkins / Maxion 6.354.4 , Maquinas agrícolas , Entrada y salida 150°	72086 72028
6354	Perkins 6.354 , 6 cilindros	005237
6355	Perkins / Maxion 6.354-4 , 20 F4 (cara de monta e 10mm)	
8550	Perkins / Maxion Fase II , 6 cilindros (M xico)	354-1-15
8628	Perkins / Maxion Fase IV , 6 cilindros (M xico)	6440 1015
9110	Perkins / Maxion 4.236 / 4.248 – D-10	72088 72013
9111	Perkins (Europa) 4.236 / 4.248 - Agrícola (No aplica en Argentina y Brasil)	
9115	Perkins / Maxion 4.236 / 4.248	72095
9120	Perkins / Maxion 4.236 -20 , GM D-20 y D-40	72087
VALTRA		
9344	VALTRA - SISU	83666344 6219695M1 836667405

	Código	Descripción	Periodo	N° Original	Equivalencia
	0354	Perkins 6.354-4 Turbo Fase 4 6 cilindros (cara de monta e 17mm) In / Out: 1/2 x 20 UNF		005365	1942/1 AK-150
	0354K	Perkins / Maxion 6.354-4 (cara de monta e 10mm) In / Out: 1/2 x 20 UNF		72096	AK-150
	1529K	Perkins (Europa) 4.203 (No aplica en Argentina y Brasil) In / Out: 1/2 x 20 UNF		25061512	1529/1 AK-004 AK-091
	1678K	Perkins / Maxion - 6.357.2 / 6.358 In / Out: 1/2 x 20 UNF		72082	1678/2 AK-110 60252
	1695K	Perkins / Maxion 3.152 3 cilindros In / Out: 1/2 x 20 UNF		72094	1695/1 AK-005
	1696K	Perkins / Maxion 3.152 MF 50 / 55 / 235 / 250 In / Out: 1/2 x 20 UNF		72084 72023	AK-005 60250

	Código	Descripción	Periodo	Nº Original	Equivalencia
	1756K	Perkins (Europa) 4.203 (cara de monta e 8mm) (No aplica en Argentina y Brasil) In / Out: 1/2 x 20 UNF		25061507	1756/2 AK-105
	1811	Perkins / Maxion MS P-4001T 4 y 6 cilindros hasta 2011 In / Out: 1/2 x 20 UNF		72111	2697 AK-183
	1812	Perkins / Maxion MS P-4001T 4 y 6 cilindros desde 2011 In / Out: 1/2 x 20 UNF		72145 7004982C1	
	1870K	Perkins / Maxion - 4.203 / D4.203 / 4.154 MF 265 (nuevo dise o similar a la original) In / Out: 1/2 x 20 UNF		72092	1870/1 AK-100
	1883	Perkins / Maxion - 4.236 / 4.248 In / Out: 1/2 x 20 UNF		72083	AK-188
	1885	Perkins / Maxion - 4203 In / Out: 1/2 x 20 UNF		72085	



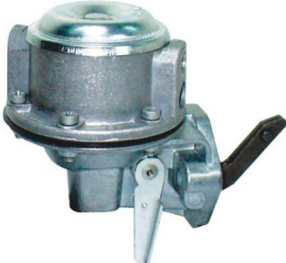



	Código	Descripción	Periodo	N° Original	Equivalencia
	1987K	Perkins / Maxion 3.152 3 cilindros In / Out: 1/2 x 20 UNF		2641712 2641704	1987 AK-083 AK-083/1
	2563K	Perkins 6.354 F4 In / Out: 1/2 x 20 UNF		25061561	2563 AK-054/1
	2567K	Perkins / Maxion 4.236 / 4.212 / 4.248 Entrada y Salida 180° In / Out: 1/2 x 20 UNF		2641A055 72095	2567 AK-063
	2568K	Perkins / Maxion 4.236 / 4.238 / 4.248 T4.236A / MF 292 / CBT In / Out: 1/2 x 20 UNF		72042	2568
	2658S	Ford Transit 2,5 Turbodiesel In / Out: 8mm		91-4F 9350 AA 90-4F 9350 AB	2658
	2693K	Perkins / Maxion 4.236 F4 (cara de monta e 10mm) In / Out: 1/2 x 20 UNF			2693





	Código	Descripción	Periodo	N° Original	Equivalencia
	3152	Perkins / Maxion 3.152, (3 cilindros) In / Out: 1/2 x 20 UNF		005859	
	4203/6305	Perkins / Maxion 4.203 / 6.305 / 6.357 / 6.358 / 6.340 / 6.288 In / Out: 1/2 x 20 UNF		005533 005236 72093 2641371	1678/2 AK-110 60252
	4236	Perkins / Maxion - 4.236 GM D-20 (monta e con 4 agujeros) In / Out: 1/2 x 20 UNF	93	72081	AK-189 60457
	4354K	Perkins / Maxion 6.354.4 Maquinas agricolas Entrada y Salida 150° In / Out: 1/2 x 20 UNF		72086 72028	60251
	6020	Bedford Chevrolet In / Out: 1/2 x 20 UNF		2636013	1549/1 AO-045
	6354	Perkins 6.354 6 cilindros In / Out: 1/2 x 20 UNF		005237	1687/1 AK-096







	Código	Descripción	Periodo	N° Original	Equivalencia
	6355	Perkins / Maxion 6.354-4 20 F4 (cara de monta e 10mm) In / Out: 1/2 x 20 UNF			
	6364	Borgward VM. - Incluye O`Ring. In / Out: 8mm		B5182004A	
	6365	Borgward Ford. - Incluye O`Ring. In / Out: 8mm		B5182003A	
	6400	Indenor In / Out: 8mm			
	6500	ohn Deere 3, 4, 6 cilindros IN / OUT 1/8 x 27 NPSF	89	5507019 RE42211 AR77914 AR53567 RE37482	1943/1 C -020 3969
	6501	ohn Deere 3,4,6 cilindros (con vaso de vidrio y filtro) IN / OUT 1/8 x 27 NPSF	89	A 52379 AR 92777	C -023

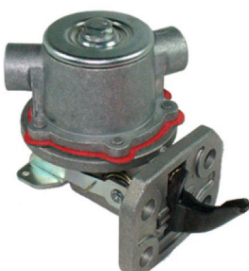

	Código	Descripción	Periodo	Nº Original	Equivalencia
	6502	ohn Deere 3,4,6 cilindros No aplica en Argentina IN / OUT 1/8 x 27 NPSF	89	AR 57264	
	6504S	ohn Deere Power Tech (sin conectores) palanca cebadora invertida In / Out: M10 x 1	2002	RE517230	
	6505S	ohn Deere. Equipo original. Sellada In / Out: 8mm	2000	RE 38009	2659 C -021
	6506S	ohn Deere. Equipo original. Sellada In / Out: 8mm	2000	RE 55390	
	6507S	ohn Deere. Motores Power Tech. Entrada conector roscado. In / Out: 9/16 x 24 UNEF	2002	RE66153 RE535728 RE545665	
	6508S	ohn Deere Power Tech (sin conectores) In / Out: M10 x 1	2002	RE559087	

	Código	Descripción	Periodo	N° Original	Equivalencia
	6509S	ohn Deere. Motores Power Tech. Entrada ca o recto In: 8mm / Out: 9/16 x 24 UNEF	2002	RE68345 RE535727 RE545664	
	6600S	Perkins / Maxion GM S10 Ford Ranger Chevrolet Blazer In / Out: 8mm		072100	TG-002
	6601S	Perkins / Maxion Ford Ranger Motor Power Stroke 2,8 In: 10mm / Out: 8mm		72119	TG-003
	6609S	Land-Rover , Defender Discovery 300 TDI In / Out: 8mm		ERR 5057 7002871C1	RV-002
	6610S	Perkins / Maxion Mercedes Benz Sprinter In / Out: 8mm		72103	TG-001
	6620	MWM motor 229 F-100 F-1000/4000 In: 10mm / Out: M14 x 1,5	92 a 96	9052002000040 7001752C1	

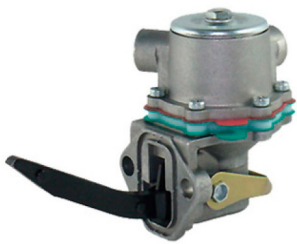
	Código	Descripción	Periodo	Nº Original	Equivalencia
	6630	MWM motor 410MA / T / TCA , 410T F-1000/4000 (modelo tama o grande) In: 10mm / Out: M14 x 1,5		9052002000041 7001753C1	TG-022
	6631	MWM motor 410MA / T / TCA, 410T; modelo tama o peque o In: 10mm / Out: M14 x 1,5		9052002000043 7001754C1	TG-022
	6640S	Cummins B 3.9 y 5.9; Bomba Iny. Rot. In: 1/4 x 18 NPTF / Out: M14 x 1,5		3904374 3966154 3970880 4983584	
	6641S	Cummins B 3.9 y 5.9 Bomba Iny. Rot. Ford F-100 In / Out: M14 x 1,5		3928144 3966155 3970881 4988769	
	6650	Cummins 6CTAA - 6CTA - 6CT (8.3 litros, 300 HP) Ford 1730 Dimex 1725 VW 17300 In: 1/2 x 14 NPTF / Out: M14 x 1,5		393 2224 393 3252 393 3253 498 8747 341 5661	
	6654	Cummins 6CTAA - 6CTA - 6CT - 6C (hasta 200 HP) Ford 1722 / 1522 VW 17220 / 15220 In: 1/4 x 18 NPTF / Out: M14 x 1,5 (Largo 28mm)		393 6318 393 6319 393 0202 493 7767	

	Código	Descripción	Periodo	N° Original	Equivalencia
	6656	Cummins BT – 6 cilindros con bomba lineal Ford 1416 Dimex 1417-8-9 VW 14160 In: 1/4 x 18 NPTF / Out: M14 x 1,5 (Largo 12mm)		393 2227 498 8748	
	8550	Perkins / Maxion Fase II , 6 cilindros (M xico) In / Out: 1/2 x 20 UNF	78	354-1-15	PE-550/05
	8628	Perkins / Maxion Fase IV , 6 cilindros (M xico) In / Out: 1/2 x 20 UNF	90	6440 1015	PE-628/05
	9110	Perkins / Maxion 4.236 / 4.248 D-10 In / Out: 1/2 x 20 UNF		72088 72013	60208
	9111	Perkins (Europa) 4.236 / 4.248 - Agricola (No aplica en Argentina y Brasil) In / Out: 1/2 x 20 UNF			AK-064
	9115	Perkins / Maxion 4.236 / 4.248 In / Out: 1/2 x 20 UNF		72095	2567 AK-063 60208

	Código	Descripción	Periodo	N° Original	Equivalencia
	9120	Perkins / Maxion 4.236 -20 , GM D-20 y D-40 In / Out: 1/2 x 20 UNF	de 03/89 a 08/91	72087	2677 AK-187 60455
	9125S	MWM Sprint 6 cil. GM Silverado DL F 100 LT In / Out: 8mm		9052002000046 7002479C1	TG-021
	9126S	MWM Sprint 6 cil. GM Silverado DL In / Out: 8mm		9052002000044 7001751C1	TG-021/1
	9210	IVECO Series 40, 50, 55, 65, 70, 616 N3/4 In / Out: M12 x 1,5		4673618 4709284 4740719 4757884 4802839	1949/5 FT-002
	9212	IVECO Series 8040, 8060 No aplica en Argentina In / Out: M12 x 1,5		800420 4802838	2518/5 FT-002/1
	9214	IVECO Serie 8065 No aplica en Argentina In / Out: M12 x 1,5		98419724	2621 FT-002/2

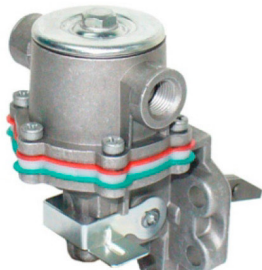
	Código	Descripción	Periodo	N° Original	Equivalencia
	9216	IVECO Series 8031, 8035, 8041, 8045 In / Out: M12 x 1,5		4609596 4648022 4660069 4667509 4709282 4740717 4756678 4757883 504090935	1947/5 FT-001
	9218	IVECO 8045 No aplica en Argentina In / Out: M12 x 1,5		99485050	2704/1
	9220	IVECO 8140 Diesel 2.5 lt (hasta 1983) No aplica en Argentina In / Out: M12 x 1,5		4279496 4724625 4740996 4749880 4755893	1946/5 FT-006
	9230	Deutz B/F 3,4,5,6 L 812 - 912 - 912 W - 913 W/T In / Out: M14 x 1.5		0423 1021 0415 0197 0210 0087 0223 9550 4238003	1662/7 P 100
	9344	VALTRA - SISU In / Out: 1/2 x 20 UNF		836666344 6219695M1 836667405	2710/1



CASA CENTRAL | MAR DEL PLATA

Av. Colon 5757 (CP 7600) | Tel: (223) 410.4000
ccentral@iturria.com.ar

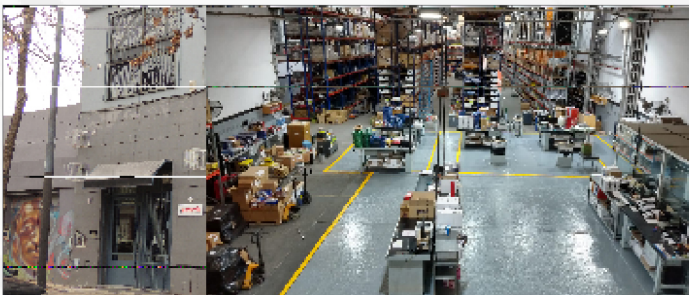

SUCURSAL CAPITAL FEDERAL

Andonaegui 1035 (C1427BEC) | Tel: (011) 3526.3020
sucursalcapital@iturria.com.ar



SUCURSAL BAHIA BLANCA

Av. Colon 1477 (B8000FUE) | Tel: (0291) 455.0333
sucursalbahia@iturria.com.ar

CATALOGO DIGITAL

Con solo un click ahora puedes hacer todas tus compras desde **catalogodigital.iturria.com.ar**

